

Silicon Epitaxial Planar Z-Diodes

Features

- Very sharp reverse characteristic
- Low reverse current level
- Available with tighter tolerances
- Very high stability
- Low noise

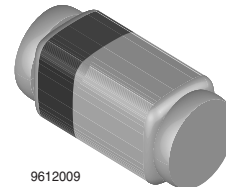

Applications

Voltage stabilization

Weight: 33.7 mg

Packaging Codes/Options:

GS08 / 2.5k per 7" reel 12.5k/box

GS18 / 10k per 13" reel 10k/box

Mechanical Data

Case: QuadroMELF SOD-80

Absolute Maximum Ratings

$T_{amb} = 25\text{ }^{\circ}\text{C}$, unless otherwise specified

Parameter	Test condition	Symbol	Value	Unit
Power dissipation	$R_{thJA} \leq 300\text{ K/W}$	P_V	500	mW
Z-current		I_Z	P_V/V_Z	mA
Junction temperature		T_j	175	$^{\circ}\text{C}$
Storage temperature range		T_{stg}	- 65 to + 175	$^{\circ}\text{C}$

Maximum Thermal Resistance

$T_{amb} = 25\text{ }^{\circ}\text{C}$, unless otherwise specified

Parameter	Test condition	Symbol	Value	Unit
Junction ambient	on PC board 50 mm x 50 mm x 1.6 mm	R_{thJA}	500	K/W

Electrical Characteristics

$T_{amb} = 25\text{ }^{\circ}\text{C}$, unless otherwise specified

Parameter	Test condition	Symbol	Min	Typ.	Max	Unit
Forward voltage	$I_F = 200\text{ mA}$	V_F			1.5	V



Electrical Characteristics

BZT55C..

Partnumber	Zener Voltage Range ¹⁾		Dynamic Resistance		Test Current	Temperature Coefficient		Test Current	Reverse Leakage Current		
	$V_Z @ I_{ZT}$		$r_{zj} @ I_{ZT}, f = 1 \text{ kHz}$			TK _{VZ}			$I_R @ T_{amb} = 25^\circ\text{C}$	$I_R @ T_{amb} = 150^\circ\text{C}$	@ V _R
	V		Ω		mA	%K		mA	μA		V
	min	max				min	max				
BZT55C2V4	2.28	2.56	< 85	< 600	5	-0.09	-0.06	1	< 50	< 100	1
BZT55C2V7	2.5	2.9	< 85	< 600	5	-0.09	-0.06	1	< 10	< 50	1
BZT55C3V0	2.8	3.2	< 90	< 600	5	-0.08	-0.05	1	< 4	< 40	1
BZT55C3V3	3.1	3.5	< 90	< 600	5	-0.08	-0.05	1	< 2	< 40	1
BZT55C3V6	3.4	3.8	< 90	< 600	5	-0.08	-0.05	1	< 2	< 40	1
BZT55C3V9	3.7	4.1	< 90	< 600	5	-0.08	-0.05	1	< 2	< 40	1
BZT55C4V3	4	4.6	< 90	< 600	5	-0.06	-0.03	1	< 1	< 20	1
BZT55C4V7	4.4	5	< 80	< 600	5	-0.05	0.02	1	< 0.5	< 10	1
BZT55C5V1	4.8	5.4	< 60	< 550	5	-0.02	0.02	1	< 0.1	< 2	1
BZT55C5V6	5.2	6	< 40	< 450	5	-0.05	+0.05	1	< 0.1	< 2	1
BZT55C6V2	5.8	6.6	< 10	< 200	5	0.03	0.06	1	< 0.1	< 2	2
BZT55C6V8	6.4	7.2	< 8	< 150	5	0.03	0.07	1	< 0.1	< 2	3
BZT55C7V5	7	7.9	< 7	< 50	5	0.03	0.07	1	< 0.1	< 2	5
BZT55C8V2	7.7	8.7	< 7	< 50	5	0.03	0.08	1	< 0.1	< 2	6.2
BZT55C9V1 *	8.5	9.6	< 10	< 50	5	0.03	0.09	1	< 0.1	< 2	6.8
BZT55C10 *	9.4	10.6	< 15	< 70	5	0.03	0.1	1	< 0.1	< 2	7.5
BZT55C11 *	10.4	11.6	< 20	< 70	5	0.03	0.11	1	< 0.1	< 2	8.2
BZT55C12 *	11.4	12.7	< 20	< 90	5	0.03	0.11	1	< 0.1	< 2	9.1
BZT55C13 *	12.4	14.1	< 26	< 110	5	0.03	0.11	1	< 0.1	< 2	10
BZT55C15 *	13.8	15.6	< 30	< 110	5	0.03	0.11	1	< 0.1	< 2	11
BZT55C16 *	15.3	17.1	< 40	< 170	5	0.03	0.11	1	< 0.1	< 2	12
BZT55C18 *	16.8	19.1	< 50	< 170	5	0.03	0.11	1	< 0.1	< 2	13
BZT55C20 *	18.8	21.2	< 55	< 220	5	0.03	0.11	1	< 0.1	< 2	15
BZT55C22 *	20.8	23.3	< 55	< 220	5	0.04	0.12	1	< 0.1	< 2	16
BZT55C24 *	22.8	25.6	< 80	< 220	5	0.04	0.12	1	< 0.1	< 2	18
BZT55C27 *	25.1	28.9	< 80	< 220	5	0.04	0.12	1	< 0.1	< 2	20
BZT55C30 *	28	32	< 80	< 220	5	0.04	0.12	1	< 0.1	< 2	22
BZT55C33 *	31	35	< 80	< 220	5	0.04	0.12	1	< 0.1	< 2	24
BZT55C36 *	34	38	< 80	< 220	5	0.04	0.12	1	< 0.1	< 2	27
BZT55C39 *	37	41	< 90	< 500	2.5	0.04	0.12	0.5	< 0.1	< 5	30
BZT55C43 *	40	46	< 90	< 600	2.5	0.04	0.12	0.5	< 0.1	< 5	33
BZT55C47 *	44	50	< 110	< 700	2.5	0.04	0.12	0.5	< 0.1	< 5	36
BZT55C51 *	48	54	< 125	< 700	2.5	0.04	0.12	0.5	< 0.1	< 10	39
BZT55C56 *	52	60	< 135	< 1000	2.5	0.04	0.12	0.5	< 0.1	< 10	43
BZT55C62 *	58	66	< 150	< 1000	2.5	0.04	0.12	0.5	< 0.1	< 10	47
BZT55C68 *	64	72	< 200	< 1000	2.5	0.04	0.12	0.5	< 0.1	< 10	51
BZT55C75 *	70	79	< 250	< 1500	2.5	0.04	0.12	0.5	< 0.1	< 10	56

¹⁾ $t_p \leq 10 \text{ ms}, T/t_p > 1000.$

²⁾ Additional measurement of Voltage group 9V1 to 75 at 95 % $V_{zmin} \leq 35 \text{ nA}$ at $T_j 25^\circ\text{C}$



Electrical Characteristics

BZT55B..

Partnumber	Zener Voltage Range ¹⁾		Dynamic Resistance		Test Current	Temperature Coefficient of Zener Voltage		Test Current	Reverse Leakage Current		
	$V_Z @ I_{ZT}$		$r_{zj} @ I_{ZT}, f = 1 \text{ kHz}$			TK _{VZ}			$I_R @ T_{amb} = 25^\circ\text{C}$	$I_R @ T_{amb} = 150^\circ\text{C}$	@V _R
	min	max	Ω	Ω	mA	%/K	min	max	mA	μA	V
BZT55B2V4	2.35	2.45	< 85	< 600	5	-0.09	-0.06	1	< 50	< 100	1
BZT55B2V7	2.64	2.76	< 85	< 600	5	-0.09	-0.06	1	< 10	< 50	1
BZT55B3V0	2.94	3.06	< 90	< 600	5	-0.08	-0.05	1	< 4	< 40	1
BZT55B3V3	3.24	3.36	< 90	< 600	5	-0.08	-0.05	1	< 2	< 40	1
BZT55B3V6	3.52	3.68	< 90	< 600	5	-0.08	-0.05	1	< 2	< 40	1
BZT55B3V9	3.82	3.98	< 90	< 600	5	-0.08	-0.05	1	< 2	< 40	1
BZT55B4V3	4.22	4.38	< 90	< 600	5	-0.06	-0.03	1	< 1	< 20	1
BZT55B4V7	4.6	4.8	< 80	< 600	5	-0.05	0.02	1	< 0.5	< 10	1
BZT55B5V1	5	5.2	< 60	< 550	5	-0.02	0.02	1	< 0.1	< 2	1
BZT55B5V6	5.48	5.72	< 40	< 450	5	-0.05	0.05	1	< 0.1	< 2	1
BZT55B6V2	6.08	6.32	< 10	< 200	5	0.03	0.06	1	< 0.1	< 2	2
BZT55B6V8	6.66	6.94	< 8	< 150	5	0.03	0.07	1	< 0.1	< 2	3
BZT55B7V5	7.35	7.65	< 7	< 50	5	0.03	0.07	1	< 0.1	< 2	5
BZT55B8V2	8.04	8.36	< 7	< 50	5	0.03	0.08	1	< 0.1	< 2	6.2
BZT55B9V1 *	8.92	9.28	< 10	< 50	5	0.03	0.09	1	< 0.1	< 2	6.8
BZT55B10 *	9.8	10.2	< 15	< 70	5	0.03	0.1	1	< 0.1	< 2	7.5
BZT55B11 *	10.78	11.22	< 20	< 70	5	0.03	0.11	1	< 0.1	< 2	8.2
BZT55B12 *	11.76	12.24	< 20	< 90	5	0.03	0.11	1	< 0.1	< 2	9.1
BZT55B13 *	12.74	13.26	< 26	< 110	5	0.03	0.11	1	< 0.1	< 2	10
BZT55B15 *	14.7	15.3	< 30	< 110	5	0.03	0.11	1	< 0.1	< 2	11
BZT55B16 *	15.7	16.3	< 40	< 170	5	0.03	0.11	1	< 0.1	< 2	12
BZT55B18 *	17.64	18.36	< 50	< 170	5	0.03	0.11	1	< 0.1	< 2	13
BZT55B20 *	19.6	20.4	< 55	< 220	5	0.03	0.11	1	< 0.1	< 2	15
BZT55B22 *	21.55	22.45	< 55	< 220	5	0.04	0.12	1	< 0.1	< 2	16
BZT55B24 *	23.5	24.5	< 80	< 220	5	0.04	0.12	1	< 0.1	< 2	18
BZT55B27 *	26.4	27.6	< 80	< 220	5	0.04	0.12	1	< 0.1	< 2	20
BZT55B30 *	29.4	30.6	< 80	< 220	5	0.04	0.12	1	< 0.1	< 2	22
BZT55B33 *	32.4	33.6	< 80	< 220	5	0.04	0.12	1	< 0.1	< 2	24
BZT55B36 *	35.3	36.7	< 80	< 220	5	0.04	0.12	1	< 0.1	< 2	27
BZT55B39 *	38.2	39.8	< 90	< 500	2.5	0.04	0.12	1	< 0.1	< 5	30
BZT55B43 *	42.1	43.9	< 90	< 600	2.5	0.04	0.12	0.5	< 0.1	< 5	33
BZT55B47 *	46.1	47.9	< 110	< 700	2.5	0.04	0.12	0.5	< 0.1	< 5	36
BZT55B51 *	50	52	< 125	< 700	2.5	0.04	0.12	0.5	< 0.1	< 10	39
BZT55B56 *	54.9	57.1	< 135	< 1000	2.5	0.04	0.12	0.5	< 0.1	< 10	43
BZT55B62 *	60.8	63.2	< 150	< 1000	2.5	0.04	0.12	0.5	< 0.1	< 10	47
BZT55B68 *	66.6	69.4	< 200	< 1000	2.5	0.04	0.12	0.5	< 0.1	< 10	51
BZT55B75 *	73.5	76.5	< 250	< 1500	2.5	0.04	0.12	0.5	< 0.1	< 10	56

¹⁾ $t_p \leq 10 \text{ ms}, T/t_p > 1000.$

^{*)} Additional measurement of Voltage group 9V1 to 75 at 95 % $V_{zmin} \leq 35 \text{ nA}$ at $T_j 25^\circ\text{C}$

Typical Characteristics ($T_{amb} = 25\text{ }^{\circ}\text{C}$ unless otherwise specified)

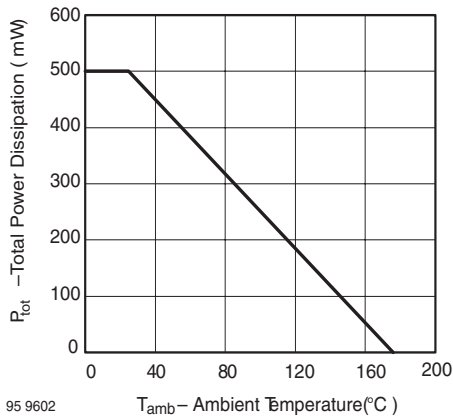

Figure 1. Total Power Dissipation vs. Ambient Temperature

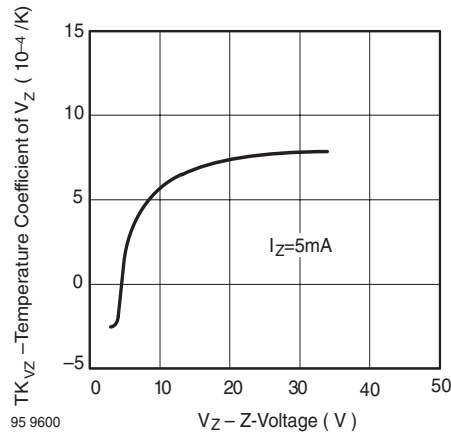

Figure 4. Temperature Coefficient of Vz vs. Z-Voltage

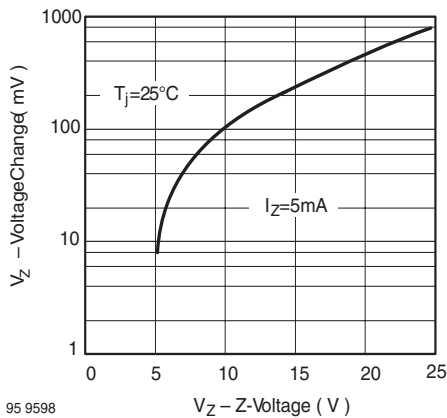

Figure 2. Typical Change of Working Voltage under Operating Conditions at $T_{amb}=25\text{ }^{\circ}\text{C}$

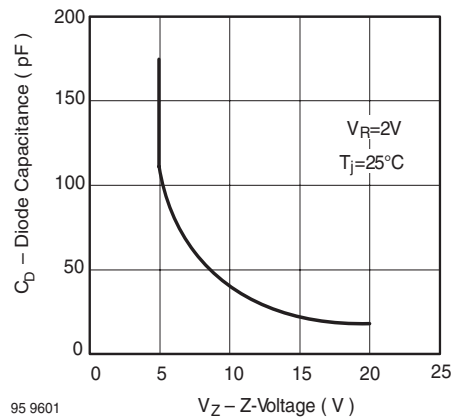

Figure 5. Diode Capacitance vs. Z-Voltage

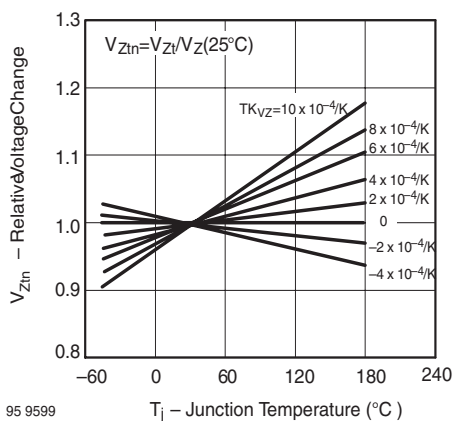

Figure 3. Typical Change of Working Voltage vs. Junction Temperature

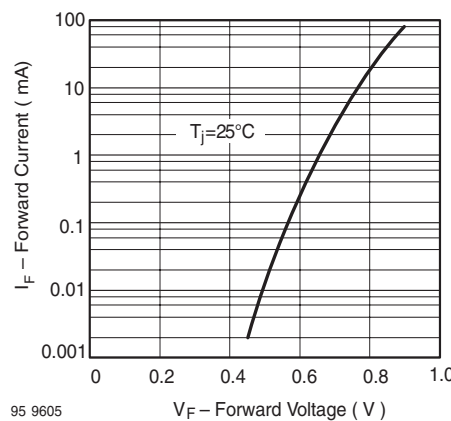

Figure 6. Forward Current vs. Forward Voltage

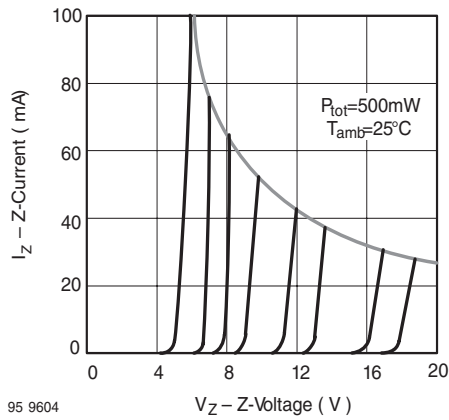

Figure 7. Z-Current vs. Z-Voltage

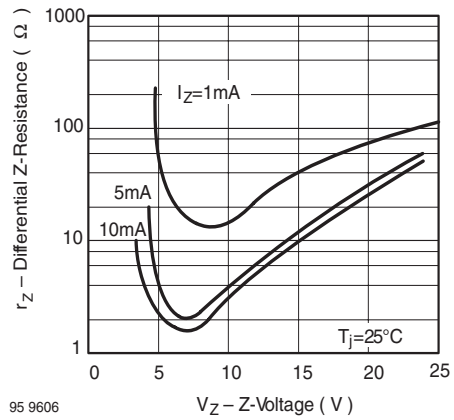

Figure 9. Differential Z-Resistance vs. Z-Voltage

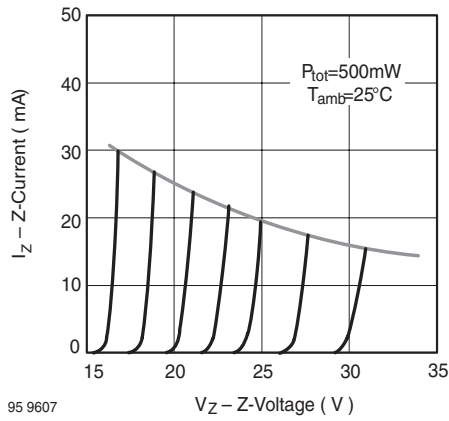

Figure 8. Z-Current vs. Z-Voltage

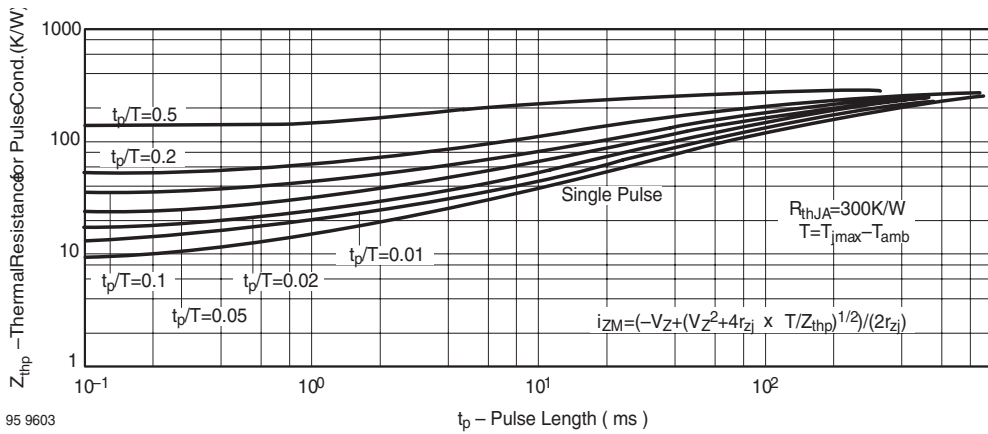

Figure 10. Thermal Response

BZT55..Series

Vishay Semiconductors



Package Dimensions in mm

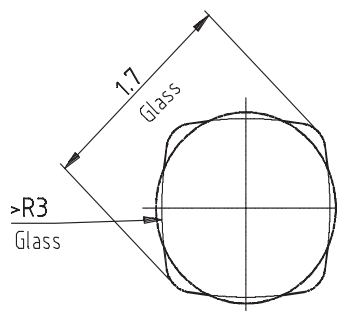
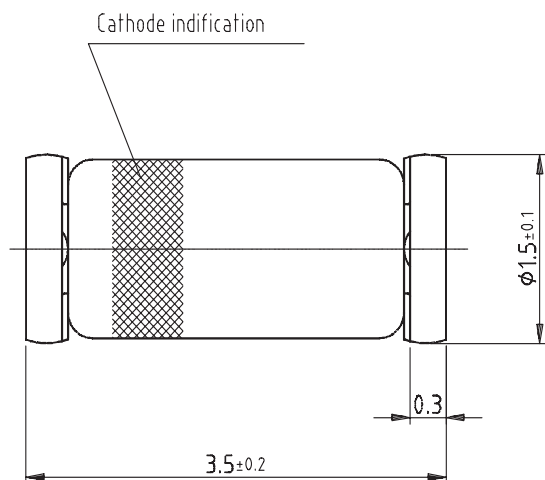

Glass case
Quadro MELF / SOD80
similar to JEDEC 213 AA

96 12071

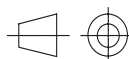

technical drawings
according to DIN
specifications



Ozone Depleting Substances Policy Statement

It is the policy of **Vishay Semiconductor GmbH** to

1. Meet all present and future national and international statutory requirements.
2. Regularly and continuously improve the performance of our products, processes, distribution and operating systems with respect to their impact on the health and safety of our employees and the public, as well as their impact on the environment.

It is particular concern to control or eliminate releases of those substances into the atmosphere which are known as ozone depleting substances (ODSs).

The Montreal Protocol (1987) and its London Amendments (1990) intend to severely restrict the use of ODSs and forbid their use within the next ten years. Various national and international initiatives are pressing for an earlier ban on these substances.

Vishay Semiconductor GmbH has been able to use its policy of continuous improvements to eliminate the use of ODSs listed in the following documents.

1. Annex A, B and list of transitional substances of the Montreal Protocol and the London Amendments respectively
2. Class I and II ozone depleting substances in the Clean Air Act Amendments of 1990 by the Environmental Protection Agency (EPA) in the USA
3. Council Decision 88/540/EEC and 91/690/EEC Annex A, B and C (transitional substances) respectively.

Vishay Semiconductor GmbH can certify that our semiconductors are not manufactured with ozone depleting substances and do not contain such substances.

**We reserve the right to make changes to improve technical design
and may do so without further notice.**

Parameters can vary in different applications. All operating parameters must be validated for each customer application by the customer. Should the buyer use Vishay Semiconductors products for any unintended or unauthorized application, the buyer shall indemnify Vishay Semiconductors against all claims, costs, damages, and expenses, arising out of, directly or indirectly, any claim of personal damage, injury or death associated with such unintended or unauthorized use.

Vishay Semiconductor GmbH, P.O.B. 3535, D-74025 Heilbronn, Germany
Telephone: 49 (0)7131 67 2831, Fax number: 49 (0)7131 67 2423