

WARP2 SERIES IGBT WITH  
ULTRAFAST SOFT RECOVERY DIODE

**Applications**

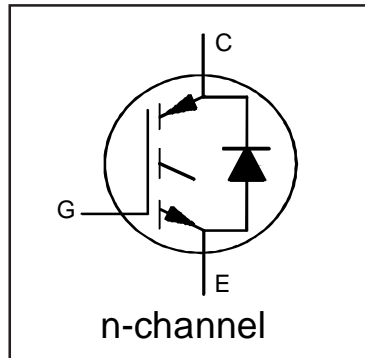
- Telecom and Server SMPS
- PFC and ZVS SMPS Circuits
- Uninterruptable Power Supplies
- Consumer Electronics Power Supplies

**Features**

- NPT Technology, Positive Temperature Coefficient
- Lower  $V_{CE(SAT)}$
- Lower Parasitic Capacitances
- Minimal Tail Current
- HEXFRED Ultra Fast Soft-Recovery Co-Pack Diode
- Tighter Distribution of Parameters
- Higher Reliability

**Benefits**

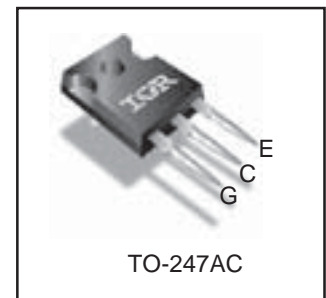
- Parallel Operation for Higher Current Applications
- Lower Conduction Losses and Switching Losses
- Higher Switching Frequency up to 150kHz



$V_{CES} = 600V$   
 $V_{CE(on)} \text{ typ.} = 1.85V$   
 @  $V_{GE} = 15V$   $I_C = 22A$

**Equivalent MOSFET Parameters**①

$R_{CE(on)} \text{ typ.} = 84m\Omega$   
 $I_D$  (FET equivalent) = 35A



**Absolute Maximum Ratings**

	Parameter	Max.	Units
$V_{CES}$	Collector-to-Emitter Voltage	600	V
$I_C @ T_C = 25^\circ C$	Continuous Collector Current	60	A
$I_C @ T_C = 100^\circ C$	Continuous Collector Current	34	
$I_{CM}$	Pulse Collector Current (Ref. Fig. C.T.4)	120	
$I_{LM}$	Clamped Inductive Load Current ②	120	
$I_F @ T_C = 25^\circ C$	Diode Continuous Forward Current	40	
$I_F @ T_C = 100^\circ C$	Diode Continuous Forward Current	15	
$I_{FRM}$	Maximum Repetitive Forward Current ③	60	
$V_{GE}$	Gate-to-Emitter Voltage	$\pm 20$	
$P_D @ T_C = 25^\circ C$	Maximum Power Dissipation	308	W
$P_D @ T_C = 100^\circ C$	Maximum Power Dissipation	123	
$T_J$	Operating Junction and	-55 to +150	$^\circ C$
$T_{STG}$	Storage Temperature Range		
	Soldering Temperature for 10 sec.		
	Mounting Torque, 6-32 or M3 Screw	10 lbf-in (1.1 N-m)	

**Thermal Resistance**

	Parameter	Min.	Typ.	Max.	Units
$R_{\theta JC}$ (IGBT)	Thermal Resistance Junction-to-Case-(each IGBT)	—	—	0.41	$^\circ C/W$
$R_{\theta JC}$ (Diode)	Thermal Resistance Junction-to-Case-(each Diode)	—	—	1.7	
$R_{\theta CS}$	Thermal Resistance, Case-to-Sink (flat, greased surface)	—	0.24	—	
$R_{\theta JA}$	Thermal Resistance, Junction-to-Ambient (typical socket mount)	—	—	40	
	Weight	—	6.0 (0.21)	—	g (oz)

## Electrical Characteristics @ T<sub>J</sub> = 25°C (unless otherwise specified)

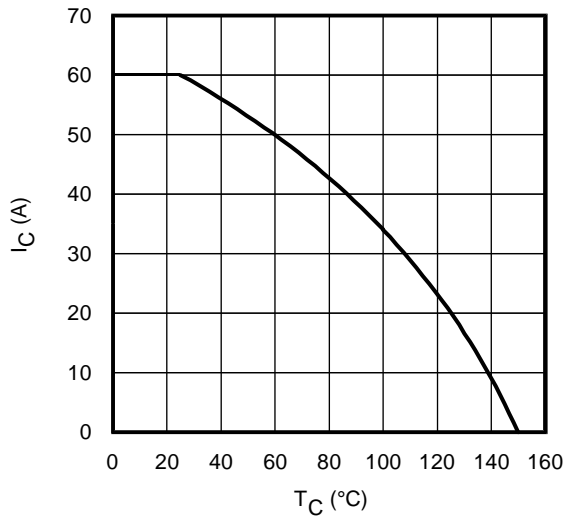
	Parameter	Min.	Typ.	Max.	Units	Conditions	Ref.Fig
V <sub>(BR)CES</sub>	Collector-to-Emitter Breakdown Voltage	600	—	—	V	V <sub>GE</sub> = 0V, I <sub>C</sub> = 500μA	
ΔV <sub>(BR)CES</sub> /ΔT <sub>J</sub>	Temperature Coeff. of Breakdown Voltage	—	0.78	—	V/°C	V <sub>GE</sub> = 0V, I <sub>C</sub> = 1mA (25°C-125°C)	
R <sub>G</sub>	Internal Gate Resistance	—	1.7	—	Ω	1MHz, Open Collector	
V <sub>CE(on)</sub>	Collector-to-Emitter Saturation Voltage	—	1.85	2.15	V	I <sub>C</sub> = 22A, V <sub>GE</sub> = 15V	4, 5, 6, 8, 9
		—	2.25	2.55		I <sub>C</sub> = 35A, V <sub>GE</sub> = 15V	
		—	2.37	2.80		I <sub>C</sub> = 22A, V <sub>GE</sub> = 15V, T <sub>J</sub> = 125°C	
		—	3.00	3.45		I <sub>C</sub> = 35A, V <sub>GE</sub> = 15V, T <sub>J</sub> = 125°C	
V <sub>GE(th)</sub>	Gate Threshold Voltage	3.0	4.0	5.0	V	I <sub>C</sub> = 250μA	7, 8, 9
ΔV <sub>GE(th)</sub> /ΔT <sub>J</sub>	Threshold Voltage temp. coefficient	—	-10	—	mV/°C	V <sub>CE</sub> = V <sub>GE</sub> , I <sub>C</sub> = 1.0mA	
g <sub>fe</sub>	Forward Transconductance	—	36	—	S	V <sub>CE</sub> = 50V, I <sub>C</sub> = 22A, PW = 80μs	
I <sub>CES</sub>	Collector-to-Emitter Leakage Current	—	3.0	375	μA	V <sub>GE</sub> = 0V, V <sub>CE</sub> = 600V	
		—	0.35	—	mA	V <sub>GE</sub> = 0V, V <sub>CE</sub> = 600V, T <sub>J</sub> = 125°C	
V <sub>FM</sub>	Diode Forward Voltage Drop	—	1.30	1.70	V	I <sub>F</sub> = 15A, V <sub>GE</sub> = 0V	10
		—	1.20	1.60		I <sub>F</sub> = 15A, V <sub>GE</sub> = 0V, T <sub>J</sub> = 125°C	
I <sub>GES</sub>	Gate-to-Emitter Leakage Current	—	—	±100	nA	V <sub>GE</sub> = ±20V, V <sub>CE</sub> = 0V	

## Switching Characteristics @ T<sub>J</sub> = 25°C (unless otherwise specified)

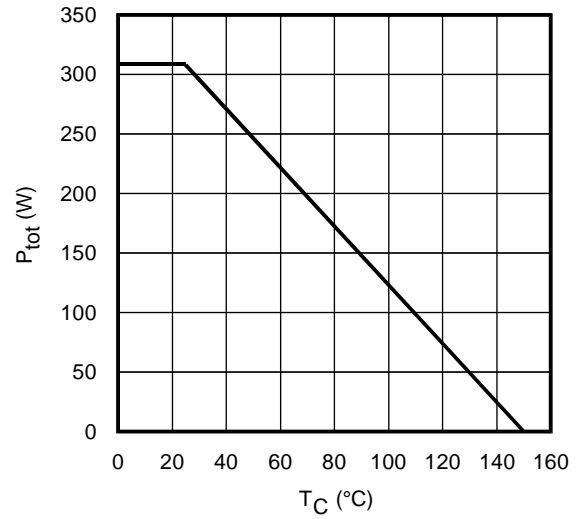
	Parameter	Min.	Typ.	Max.	Units	Conditions	Ref.Fig
Q <sub>g</sub>	Total Gate Charge (turn-on)	—	160	240	nC	I <sub>C</sub> = 22A	17
Q <sub>gc</sub>	Gate-to-Collector Charge (turn-on)	—	55	83		V <sub>CC</sub> = 400V	CT1
Q <sub>ge</sub>	Gate-to-Emitter Charge (turn-on)	—	21	32		V <sub>GE</sub> = 15V	
E <sub>on</sub>	Turn-On Switching Loss	—	220	270	μJ	I <sub>C</sub> = 22A, V <sub>CC</sub> = 390V	CT3
E <sub>off</sub>	Turn-Off Switching Loss	—	215	265		V <sub>GE</sub> = +15V, R <sub>G</sub> = 3.3Ω, L = 200μH	
E <sub>total</sub>	Total Switching Loss	—	435	535		T <sub>J</sub> = 25°C ④	
t <sub>d(on)</sub>	Turn-On delay time	—	26	34	ns	I <sub>C</sub> = 22A, V <sub>CC</sub> = 390V	CT3
t <sub>r</sub>	Rise time	—	6.0	8.0		V <sub>GE</sub> = +15V, R <sub>G</sub> = 3.3Ω, L = 200μH	
t <sub>d(off)</sub>	Turn-Off delay time	—	110	122		T <sub>J</sub> = 25°C ④	
t <sub>f</sub>	Fall time	—	8.0	10	μJ	I <sub>C</sub> = 22A, V <sub>CC</sub> = 390V	CT3
E <sub>on</sub>	Turn-On Switching Loss	—	410	465		V <sub>GE</sub> = +15V, R <sub>G</sub> = 3.3Ω, L = 200μH	11, 13
E <sub>off</sub>	Turn-Off Switching Loss	—	330	405		T <sub>J</sub> = 125°C ④	WF1, WF2
E <sub>total</sub>	Total Switching Loss	—	740	870	ns	I <sub>C</sub> = 22A, V <sub>CC</sub> = 390V	CT3
t <sub>d(on)</sub>	Turn-On delay time	—	26	34		V <sub>GE</sub> = +15V, R <sub>G</sub> = 3.3Ω, L = 200μH	12, 14
t <sub>r</sub>	Rise time	—	8.0	11		T <sub>J</sub> = 125°C ④	WF1, WF2
t <sub>d(off)</sub>	Turn-Off delay time	—	130	150	pF	V <sub>GE</sub> = 0V	16
t <sub>f</sub>	Fall time	—	12	16		V <sub>CC</sub> = 30V	
C <sub>ies</sub>	Input Capacitance	—	3715	—		f = 1Mhz	
C <sub>oes</sub>	Output Capacitance	—	265	—	pF	V <sub>GE</sub> = 0V, V <sub>CE</sub> = 0V to 480V	15
C <sub>res</sub>	Reverse Transfer Capacitance	—	47	—			
C <sub>oes eff.</sub>	Effective Output Capacitance (Time Related) ⑤	—	135	—			
C <sub>oes eff. (ER)</sub>	Effective Output Capacitance (Energy Related) ⑤	—	179	—			
RBSOA	Reverse Bias Safe Operating Area	FULL SQUARE				T <sub>J</sub> = 150°C, I <sub>C</sub> = 120A V <sub>CC</sub> = 480V, V <sub>p</sub> = 600V R <sub>g</sub> = 22Ω, V <sub>GE</sub> = +15V to 0V	3 CT2
t <sub>rr</sub>	Diode Reverse Recovery Time	—	42	60	ns	T <sub>J</sub> = 25°C I <sub>F</sub> = 15A, V <sub>R</sub> = 200V,	19
		—	74	120		T <sub>J</sub> = 125°C di/dt = 200A/μs	
Q <sub>rr</sub>	Diode Reverse Recovery Charge	—	80	180	nC	T <sub>J</sub> = 25°C I <sub>F</sub> = 15A, V <sub>R</sub> = 200V,	21
		—	220	600		T <sub>J</sub> = 125°C di/dt = 200A/μs	
I <sub>rr</sub>	Peak Reverse Recovery Current	—	4.0	6.0	A	T <sub>J</sub> = 25°C I <sub>F</sub> = 15A, V <sub>R</sub> = 200V,	19, 20, 21, 22
		—	6.5	10		T <sub>J</sub> = 125°C di/dt = 200A/μs	

### Notes:

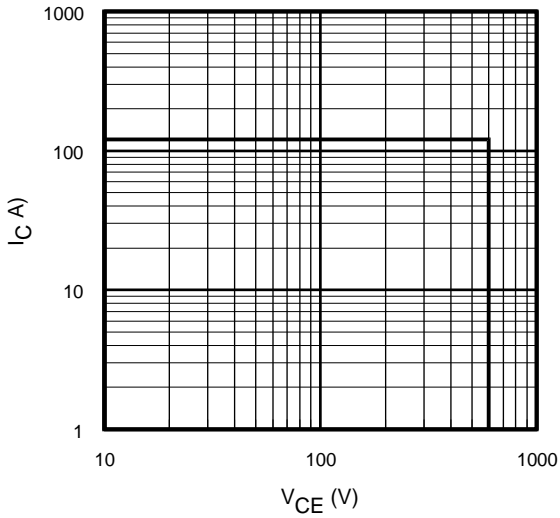
- ① R<sub>CE(on)</sub> typ. = equivalent on-resistance = V<sub>CE(on)</sub> typ./ I<sub>C</sub>, where V<sub>CE(on)</sub> typ. = 1.85V and I<sub>C</sub> = 22A. I<sub>D</sub> (FET Equivalent) is the equivalent MOSFET I<sub>D</sub> rating @ 25°C for applications up to 150kHz. These are provided for comparison purposes (only) with equivalent MOSFET solutions.
- ② V<sub>CC</sub> = 80% (V<sub>CES</sub>), V<sub>GE</sub> = 15V, L = 28 μH, R<sub>G</sub> = 22 Ω.
- ③ Pulse width limited by max. junction temperature.
- ④ Energy losses include "tail" and diode reverse recovery, Data generated with use of Diode 30ETH06.
- ⑤ C<sub>oes eff.</sub> is a fixed capacitance that gives the same charging time as C<sub>oes</sub> while V<sub>CE</sub> is rising from 0 to 80% V<sub>CES</sub>.  
C<sub>oes eff. (ER)</sub> is a fixed capacitance that stores the same energy as C<sub>oes</sub> while V<sub>CE</sub> is rising from 0 to 80% V<sub>CES</sub>.



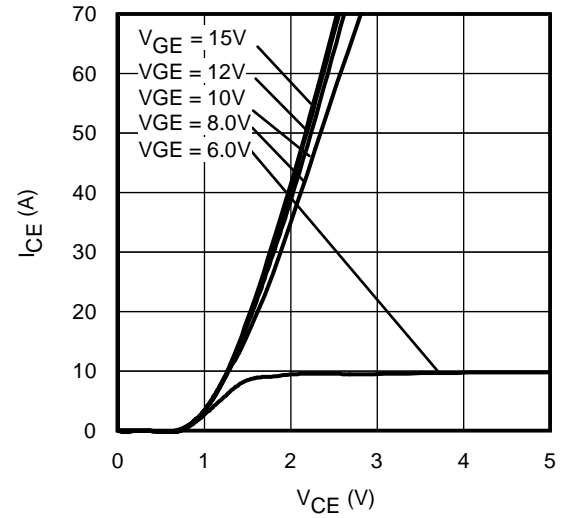
**Fig. 1** - Maximum DC Collector Current vs. Case Temperature



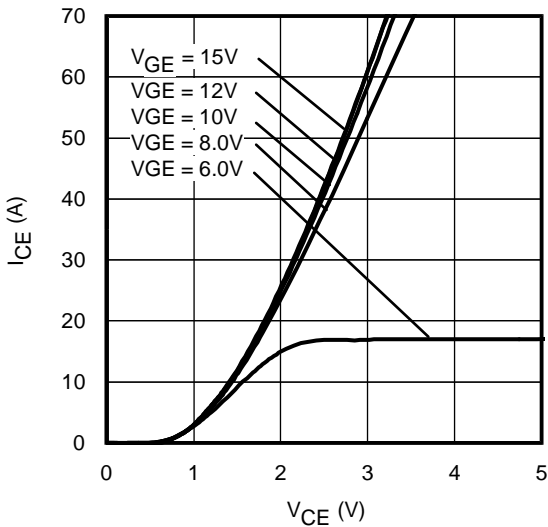
**Fig. 2** - Power Dissipation vs. Case Temperature



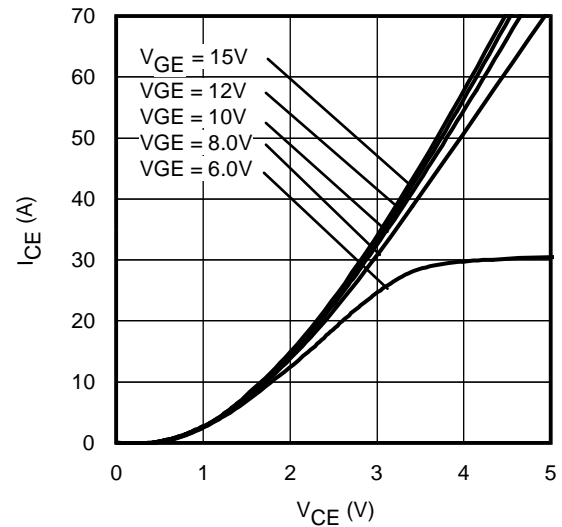
**Fig. 3** - Reverse Bias SOA  
 $T_J = 150^\circ\text{C}$ ;  $V_{GE} = 15\text{V}$



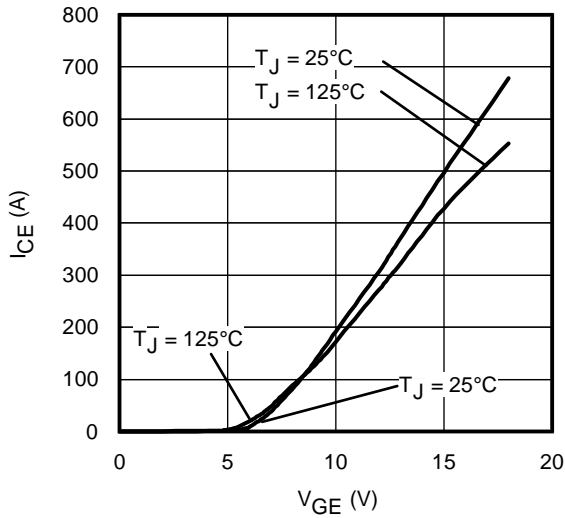
**Fig. 4** - Typ. IGBT Output Characteristics  
 $T_J = -40^\circ\text{C}$ ;  $t_p = 80\mu\text{s}$



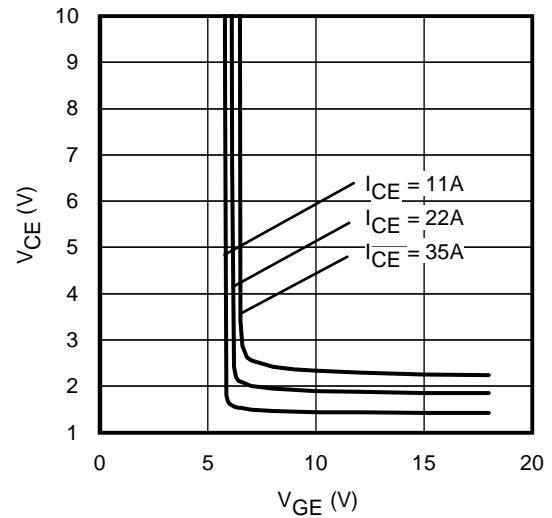
**Fig. 5** - Typ. IGBT Output Characteristics  
 $T_J = 25^\circ\text{C}$ ;  $t_p = 80\mu\text{s}$



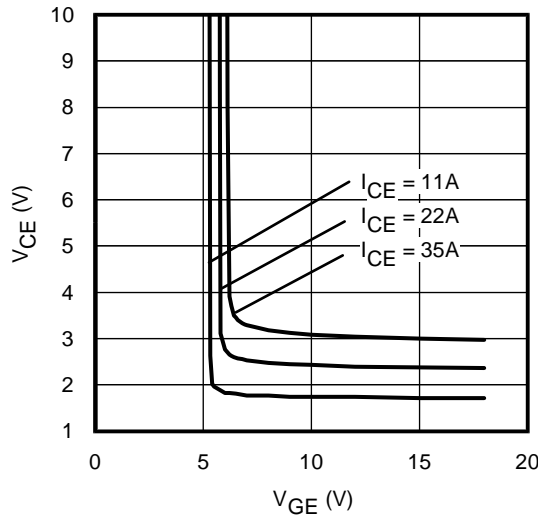
**Fig. 6** - Typ. IGBT Output Characteristics  
 $T_J = 125^\circ\text{C}$ ;  $t_p = 80\mu\text{s}$



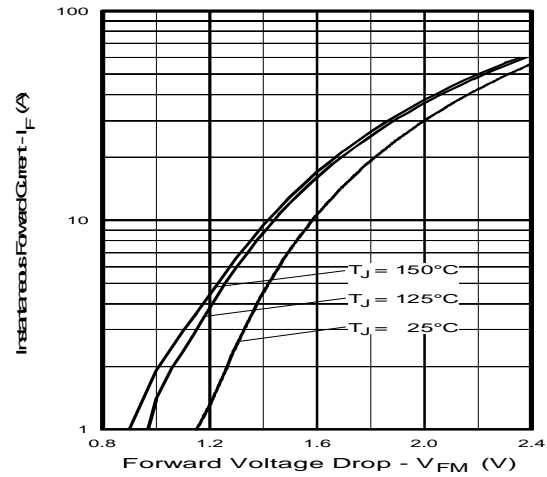
**Fig. 7** - Typ. Transfer Characteristics  
 $V_{CE} = 50V$ ;  $t_p = 10\mu s$



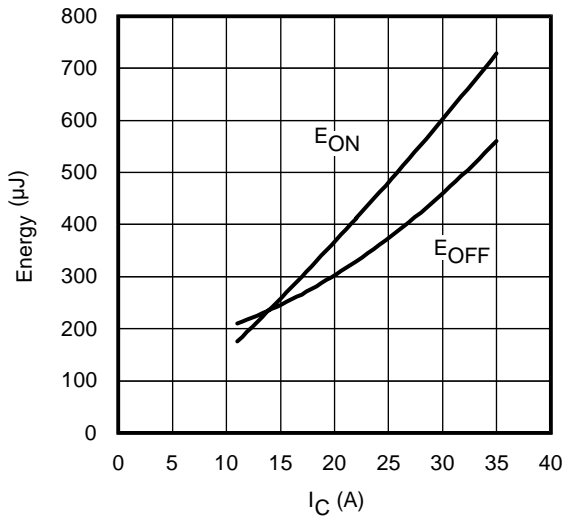
**Fig. 8** - Typical  $V_{CE}$  vs.  $V_{GE}$   
 $T_J = 25^\circ C$



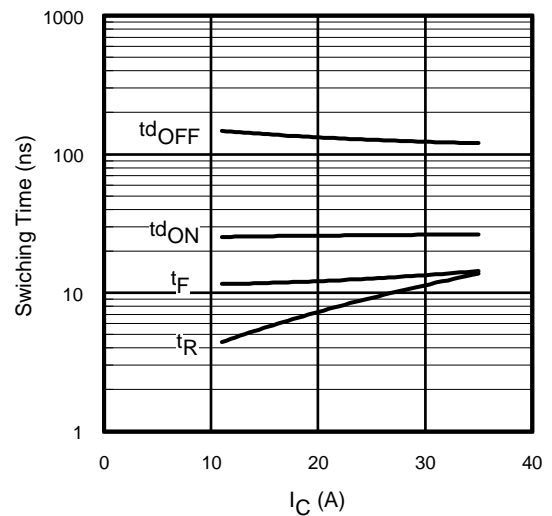
**Fig. 9** - Typical  $V_{CE}$  vs.  $V_{GE}$   
 $T_J = 125^\circ C$



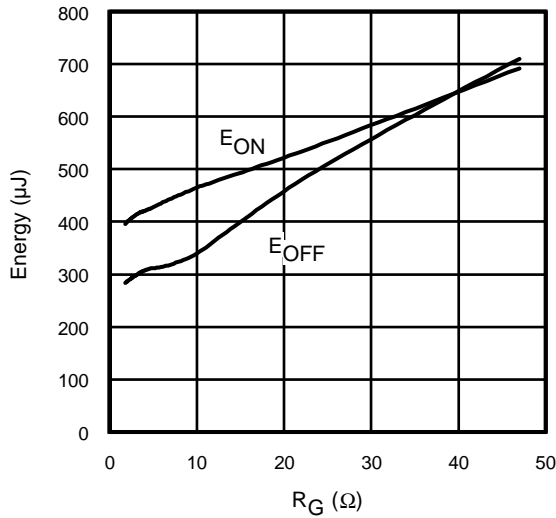
**Fig. 10** - Typ. Diode Forward Characteristics  
 $t_p = 80\mu s$



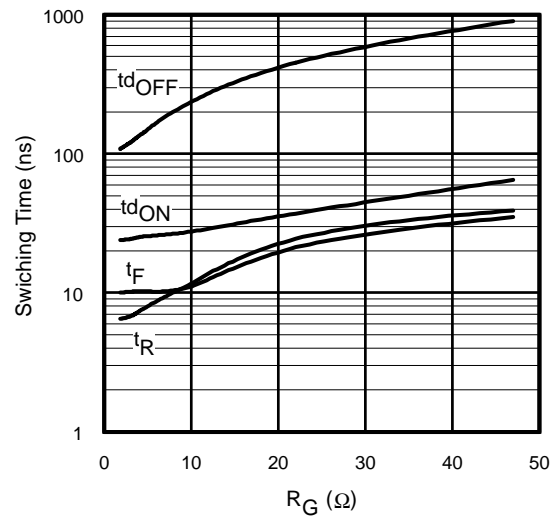
**Fig. 11** - Typ. Energy Loss vs.  $I_C$   
 $T_J = 125^\circ C$ ;  $L = 200\mu H$ ;  $V_{CE} = 390V$ ,  $R_G = 3.3\Omega$ ;  $V_{GE} = 15V$ .  
Diode clamp used: 30ETH06 (See C.T.3)



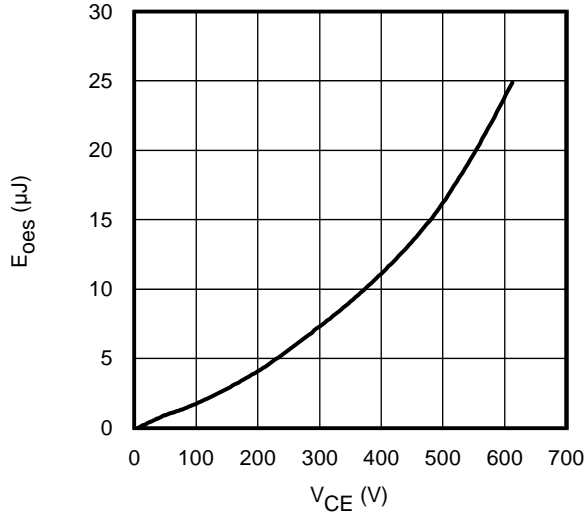
**Fig. 12** - Typ. Switching Time vs.  $I_C$   
 $T_J = 125^\circ C$ ;  $L = 200\mu H$ ;  $V_{CE} = 390V$ ,  $R_G = 3.3\Omega$ ;  $V_{GE} = 15V$ .  
Diode clamp used: 30ETH06 (See C.T.3)



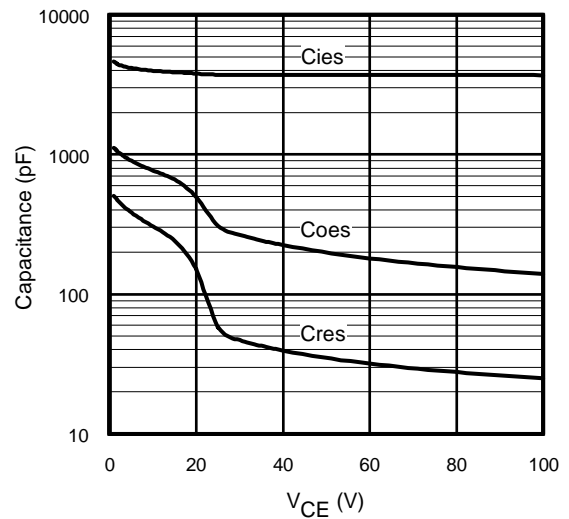
**Fig. 13 - Typ. Energy Loss vs.  $R_G$**   
 $T_J = 125^\circ\text{C}$ ;  $L = 200\mu\text{H}$ ;  $V_{CE} = 390\text{V}$ ;  $I_{CE} = 22\text{A}$ ;  $V_{GE} = 15\text{V}$   
 Diode clamp used: 30ETH06 (See C.T.3)



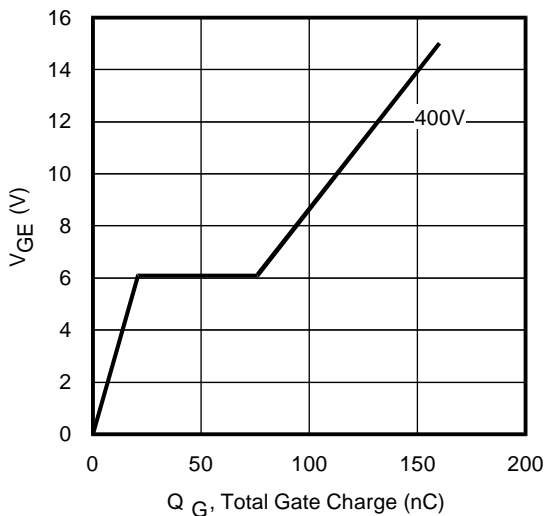
**Fig. 14 - Typ. Switching Time vs.  $R_G$**   
 $T_J = 125^\circ\text{C}$ ;  $L = 200\mu\text{H}$ ;  $V_{CE} = 390\text{V}$ ;  $I_{CE} = 22\text{A}$ ;  $V_{GE} = 15\text{V}$   
 Diode clamp used: 30ETH06 (See C.T.3)



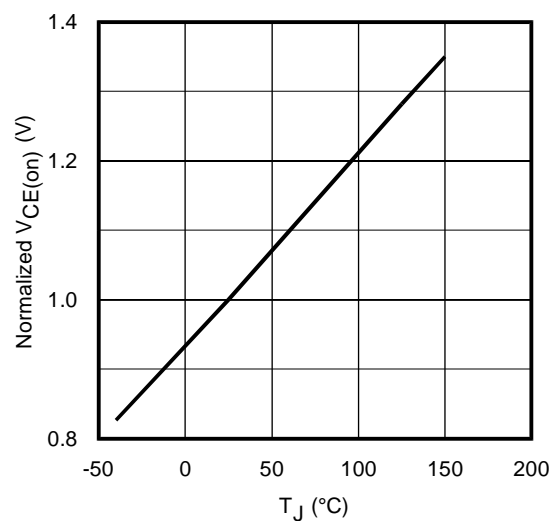
**Fig. 15- Typ. Output Capacitance  
 Stored Energy vs.  $V_{CE}$**



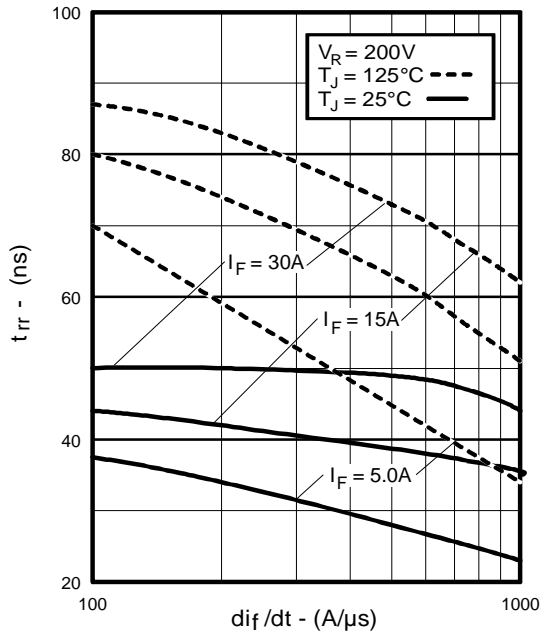
**Fig. 16- Typ. Capacitance vs.  $V_{CE}$**   
 $V_{GE} = 0\text{V}$ ;  $f = 1\text{MHz}$



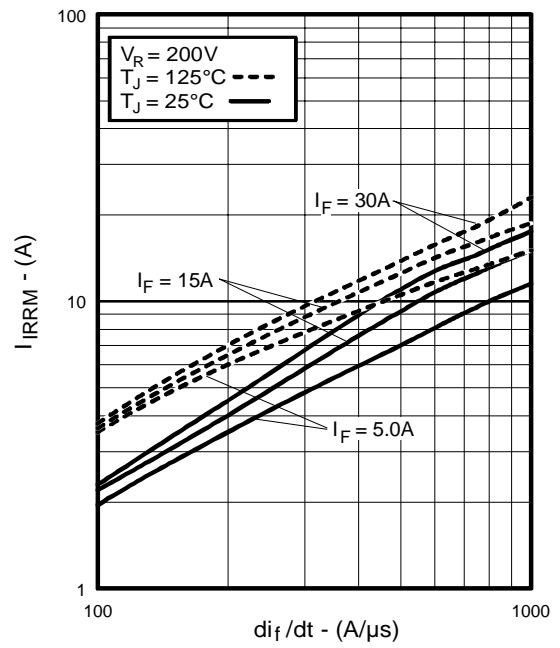
**Fig. 17 - Typical Gate Charge vs.  $V_{GE}$**   
 $I_{CE} = 22\text{A}$



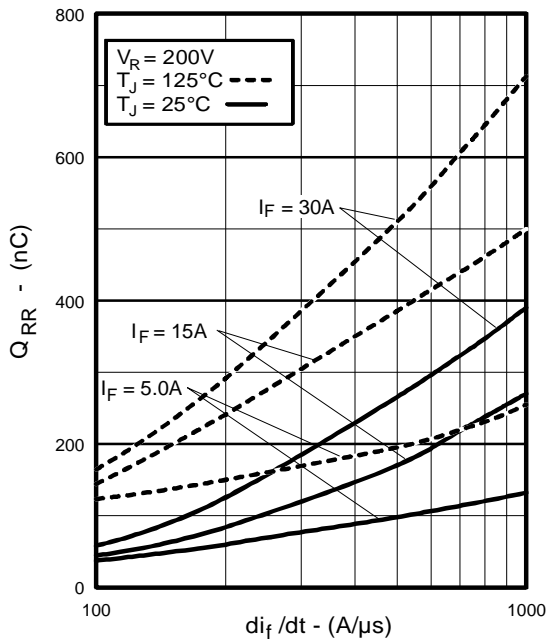
**Fig. 18 - Normalized Typ.  $V_{CE(on)}$   
 vs. Junction Temperature**  
 $I_C = 22\text{A}$ ,  $V_{GE} = 15\text{V}$



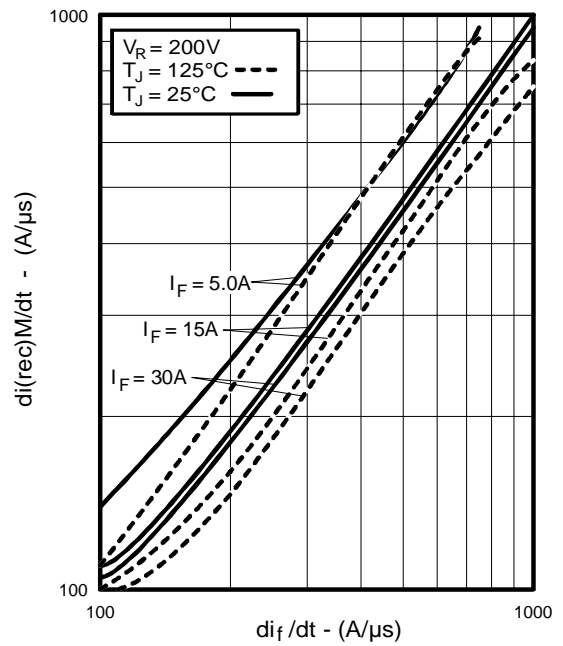
**Fig. 19** - Typical Reverse Recovery vs.  $di_f/dt$



**Fig. 20** - Typical Recovery Current vs.  $di_f/dt$



**Fig. 21** - Typical Stored Charge vs.  $di_f/dt$



**Fig. 22** - Typical  $di_{(rec)M}/dt$  vs.  $di_f/dt$

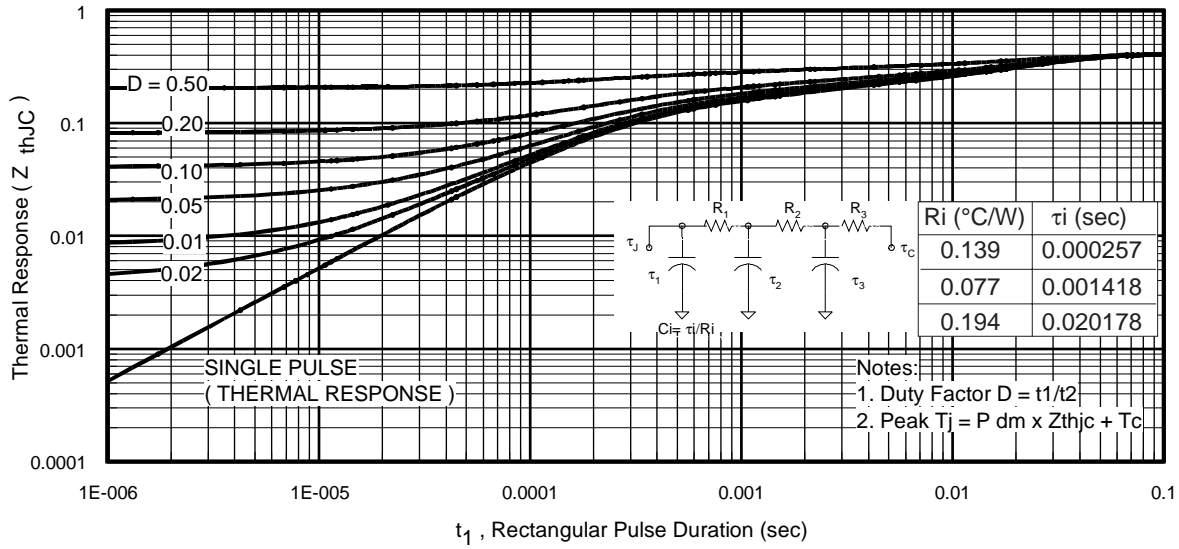


Fig 23. Maximum Transient Thermal Impedance, Junction-to-Case (IGBT)

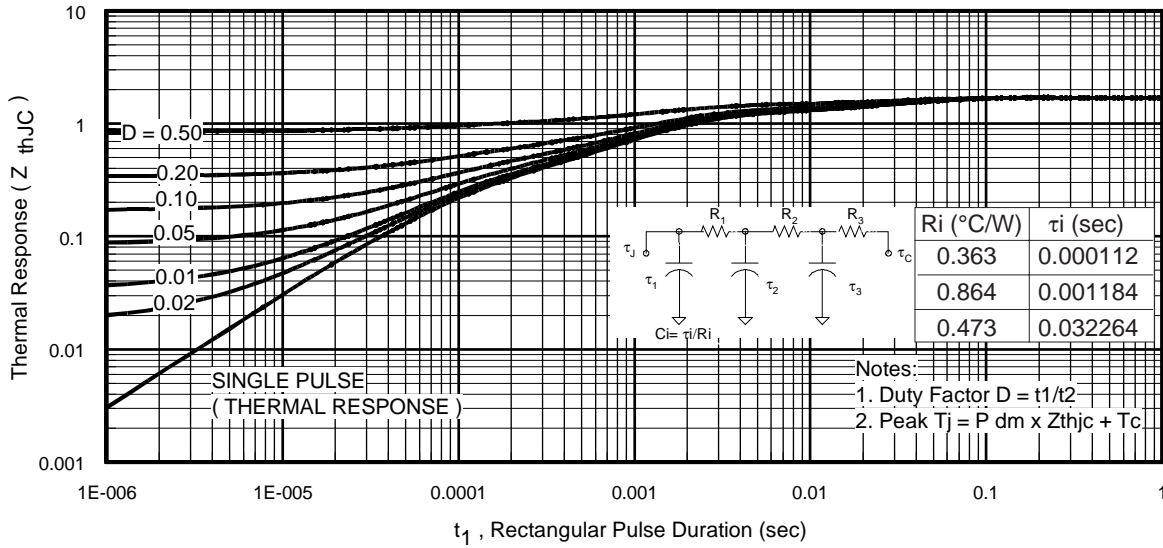
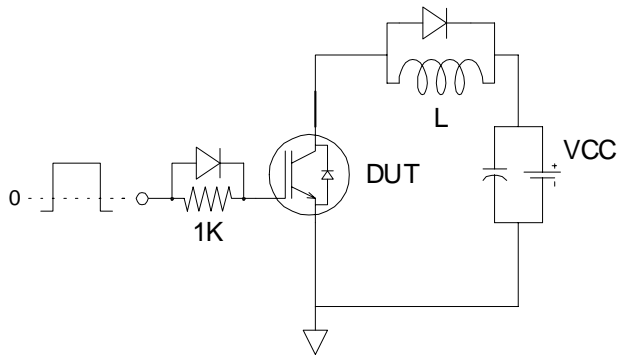
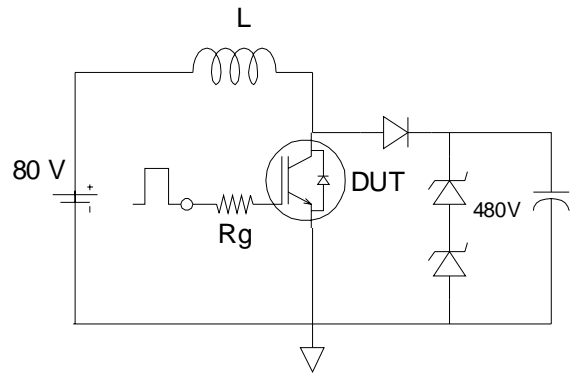


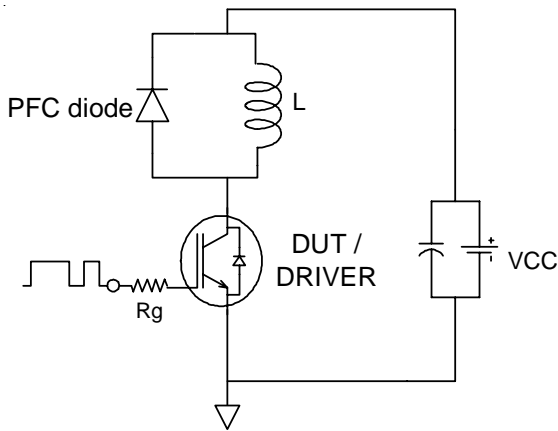
Fig. 24. Maximum Transient Thermal Impedance, Junction-to-Case (DIODE)



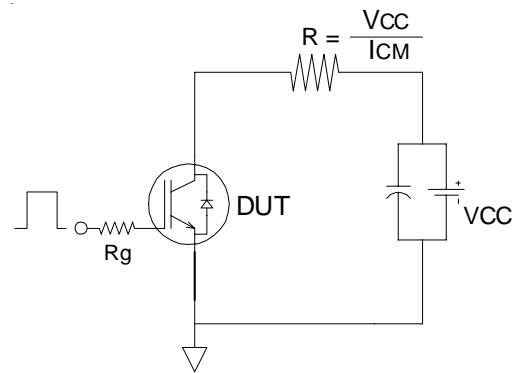
**Fig.C.T.1** - Gate Charge Circuit (turn-off)



**Fig.C.T.2** - RBSOA Circuit

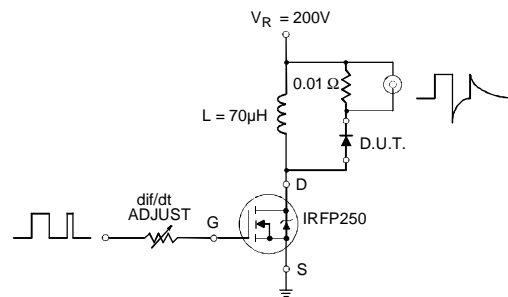


**Fig.C.T.3** - Switching Loss Circuit



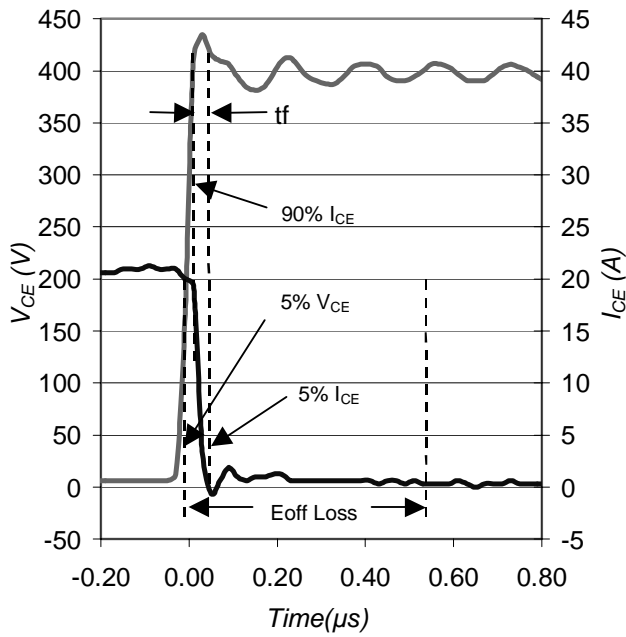
**Fig.C.T.4** - Resistive Load Circuit

### REVERSE RECOVERY CIRCUIT

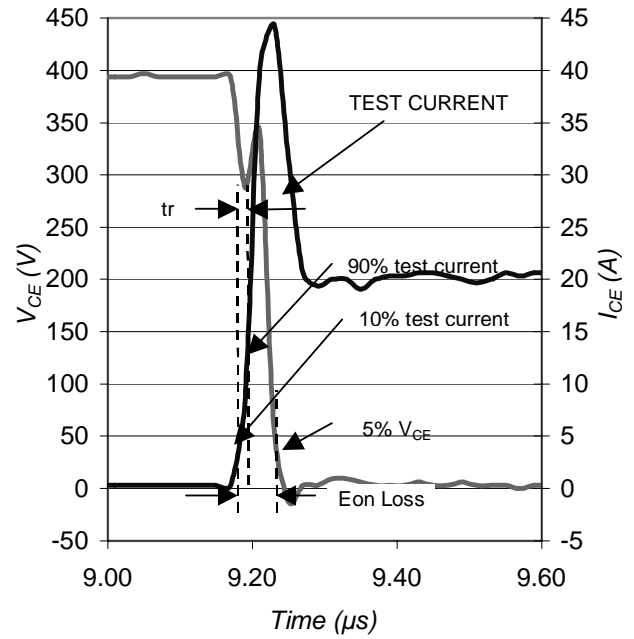


**Fig. C.T.5** - Reverse Recovery Parameter Test Circuit

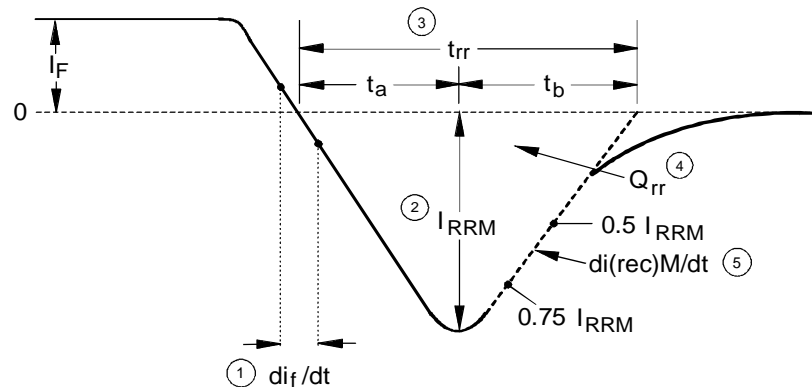




**Fig. WF1** - Typ. Turn-off Loss Waveform  
@  $T_J = 25^\circ\text{C}$  using Fig. CT.3



**Fig. WF2** - Typ. Turn-on Loss Waveform  
@  $T_J = 25^\circ\text{C}$  using Fig. CT.3



1.  $di_f/dt$  - Rate of change of current through zero crossing
2.  $I_{RRM}$  - Peak reverse recovery current
3.  $t_{rr}$  - Reverse recovery time measured from zero crossing point of negative going  $I_F$  to point where a line passing through  $0.75 I_{RRM}$  and  $0.50 I_{RRM}$  extrapolated to zero current

4.  $Q_{rr}$  - Area under curve defined by  $t_{rr}$  and  $I_{RRM}$

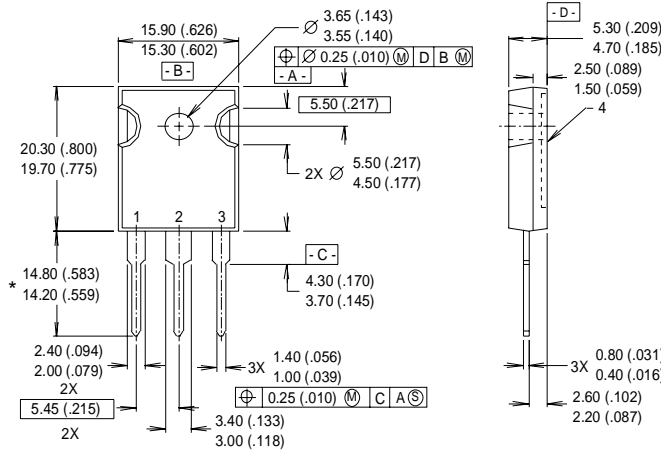
$$Q_{rr} = \frac{t_{rr} \times I_{RRM}}{2}$$

5.  $di_{(rec)M}/dt$  - Peak rate of change of current during  $t_b$  portion of  $t_{rr}$

**Fig. WF3** - Reverse Recovery Waveform and Definitions

## TO-247AC Package Outline

Dimensions are shown in millimeters (inches)



### NOTES:

- 1 DIMENSIONS & TOLERANCING PER ANSI Y14.5M, 1982.
- 2 CONTROLLING DIMENSION : INCH.
- 3 DIMENSIONS ARE SHOWN MILLIMETERS (INCHES).
- 4 CONFORMS TO JEDEC OUTLINE TO-247AC.

### LEAD ASSIGNMENTS

- 1 - GATE
- 2 - COLLECTOR
- 3 - EMITTER
- 4 - COLLECTOR

\* LONGER LEADED (20mm) VERSION AVAILABLE (TO-247AD) TO ORDER ADD "E" SUFFIX TO PART NUMBER

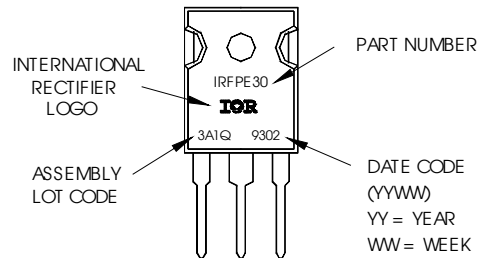
**CONFORMS TO JEDEC OUTLINE TO-247AC (TO-3P)**

Dimensions in Millimeters and (Inches)

## TO-247AC Part Marking Information

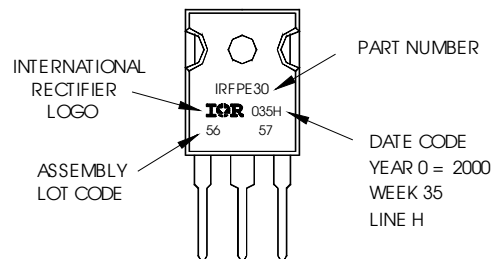
Notes: This part marking information applies to devices produced before 02/26/2001 or for parts manufactured in GB.

EXAMPLE: THIS IS AN IRFPE30 WITH ASSEMBLY LOT CODE 3A1Q



Notes: This part marking information applies to devices produced after 02/26/2001

EXAMPLE: THIS IS AN IRFPE30 WITH ASSEMBLY LOT CODE 5657 ASSEMBLED ON WW 35, 2000 IN THE ASSEMBLY LINE "H"



**TO-247AC package is not recommended for Surface Mount Application.**

Data and specifications subject to change without notice.  
This product has been designed and qualified for Industrial market.  
Qualification Standards can be found on IR's Web site.

International  
**IR** Rectifier

IR WORLD HEADQUARTERS: 233 Kansas St., El Segundo, California 90245, USA Tel: (310) 252-7105

TAC Fax: (310) 252-7903

Visit us at [www.irf.com](http://www.irf.com) for sales contact information. 12/03

[www.irf.com](http://www.irf.com)