

( Units : mm )

# • SSOP-A54

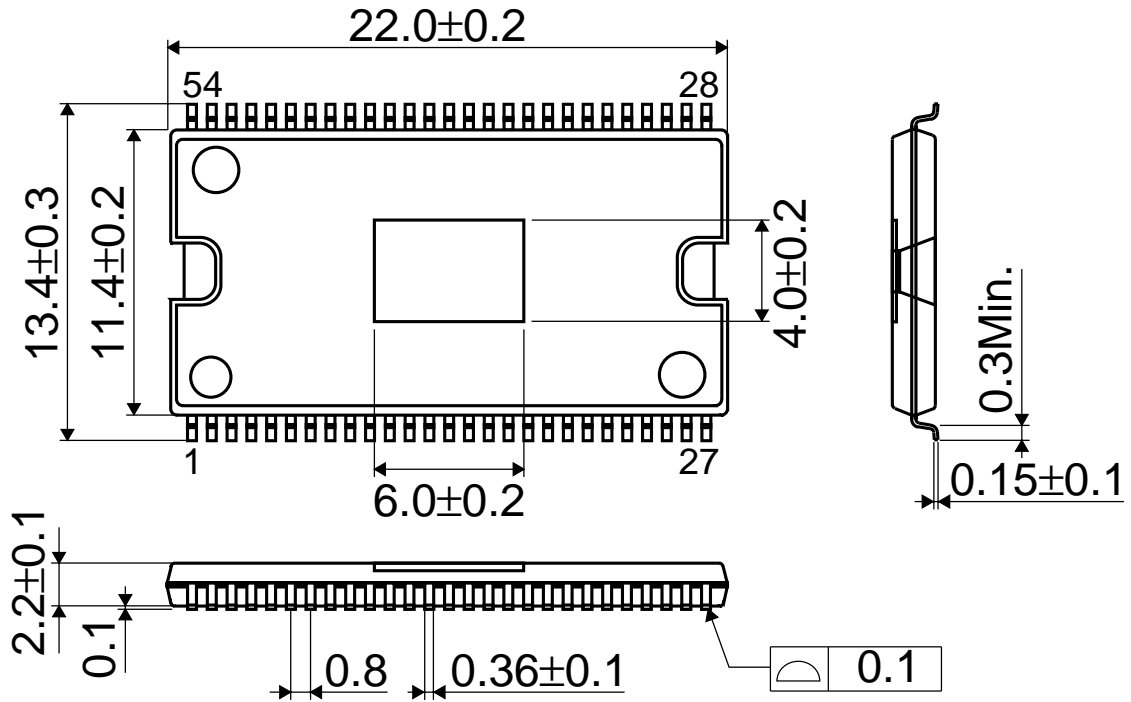

\* The contents described herein are subject to change without notice.