

# 2.0-18.0 GHz GaAs MMIC Low Noise Amplifier, QFN



August 2009 - Rev 29-Aug-09

**CMMI 100-QF**  
RoHS

## Features

- ✕ Self Bias Architecture
- ✕ 15.0 dB Small Signal Gain
- ✕ 3.8 dB Noise Figure
- ✕ +15.0 dBm P1dB Compression Point
- ✕ RoHS Compliant SMD, 4x4 mm QFN Package
- ✕ 100% RF, DC, and Noise Figure Testing



## General Description

Mimix Broadband's two stage 2.0-18.0 GHz GaAs MMIC low noise amplifier has a small signal gain of 15.0 dB with a noise figure of 3.8 dB across most of the band. This MMIC uses Mimix Broadband's GaAs PHEMT device model technology, and is based upon electron beam lithography to ensure high repeatability and uniformity. The device comes in a RoHS compliant 4x4mm QFN Surface Mount Package offering excellent RF and thermal properties. This device is well suited for fiber optic, microwave radio, military, space, telecom infrastructure, test instrumentation and VSAT applications.

## Absolute Maximum Ratings

Supply Voltage (Vd)	+8.0 VDC
Supply Current (Id1,2)	180 mA
Input Power (Pin)	+10.0 dBm
ESD Sensitivity (HBM)	450 V
Storage Temperature (Tstg)	-65 to +165 °C
Operating Temperature (Ta)	-55 to MTTF Graph <sup>1</sup>
Channel Temperature (Tch)	MTTF Graph <sup>1</sup>
Moisture Sensitivity Level	MSL3

(1) Channel temperature affects a device's MTTF. It is recommended to keep channel temperature as low as possible for maximum life.

## Electrical Characteristics (Ambient Temperature T = 25 °C)

Parameter	Units	Min.	Typ.	Max.
Frequency Range (f)	GHz	2.0	-	18.0
Input Return Loss (S11)	dB	-	8.0	-
Output Return Loss (S22)	dB	-	10.0	-
Small Signal Gain (S21)	dB	-	15.0	-
Gain Flatness ( $\Delta S21$ )	dB	-	+/-1.0	-
Reverse Isolation (S12)	dB	-	35.0	-
Noise Figure (NF)	dB	-	3.8	-
Output Power for 1dB Compression (P1dB)	dBm	-	+15.0	-
Output Second Order Intercept Point (OIP2)	dBm	-	+36.0	-
Output Third Order Intercept Point (OIP3)	dBm	-	+25.0	-
Drain Bias Voltage (Vd)	VDC	-	+5.0	+7.0
Supply Current (Id) (Vd=5.0V Typical)	mA	90	100	120

# 2.0-18.0 GHz GaAs MMIC Low Noise Amplifier, QFN



August 2009 - Rev 29-Aug-09

**CMM1100-QF**  
RoHS

## Low Noise Amplifier Measurements

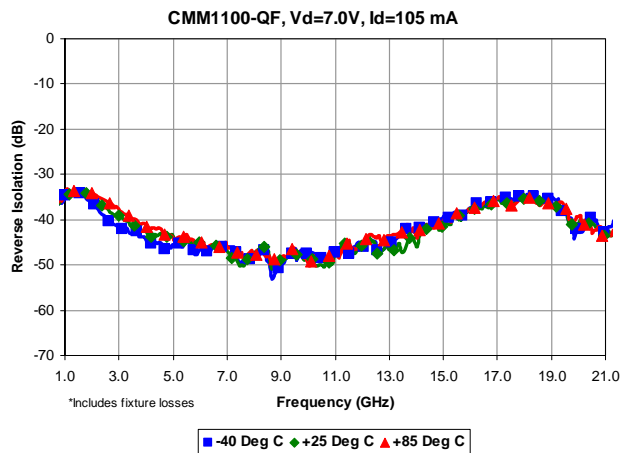
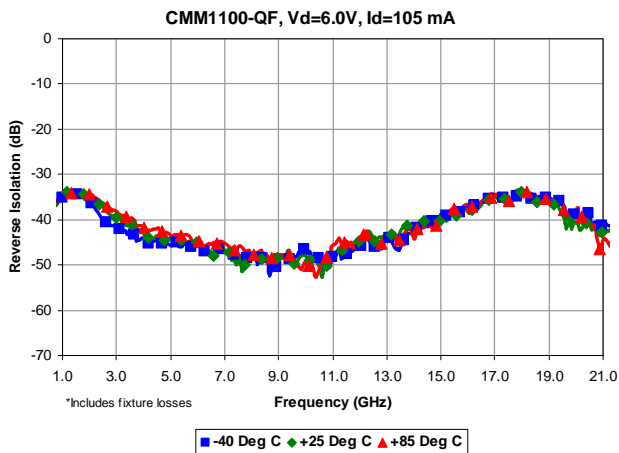
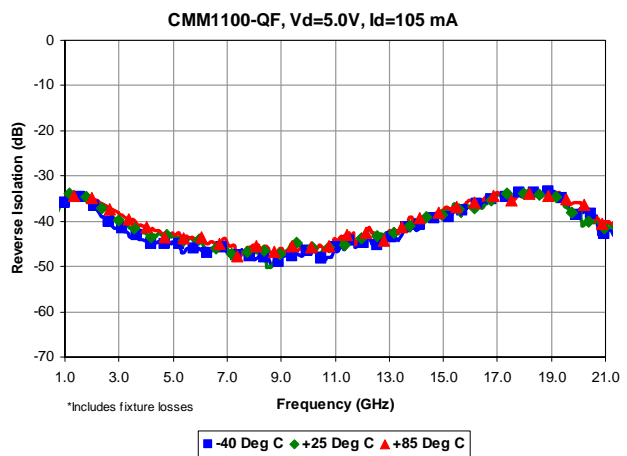
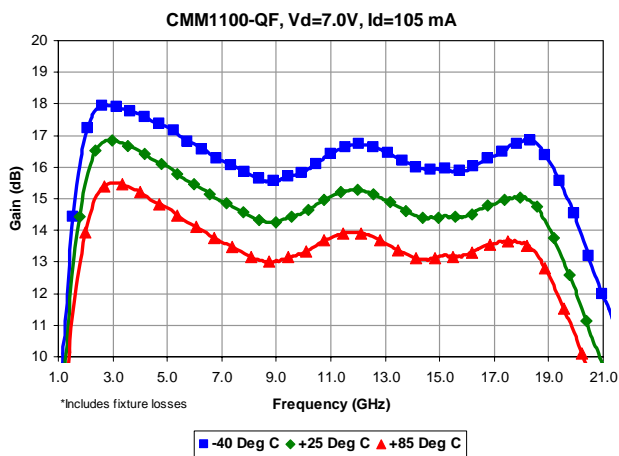
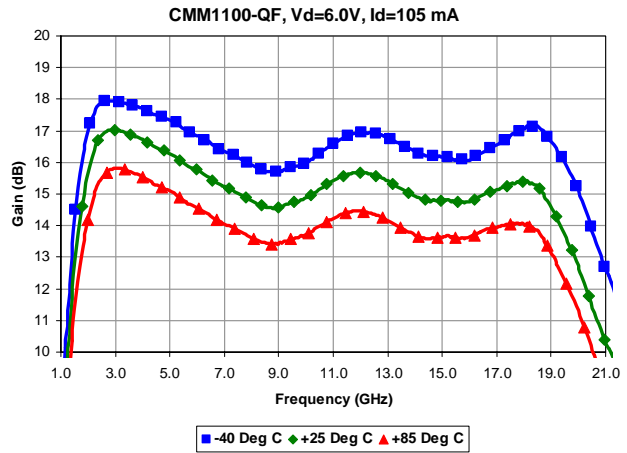
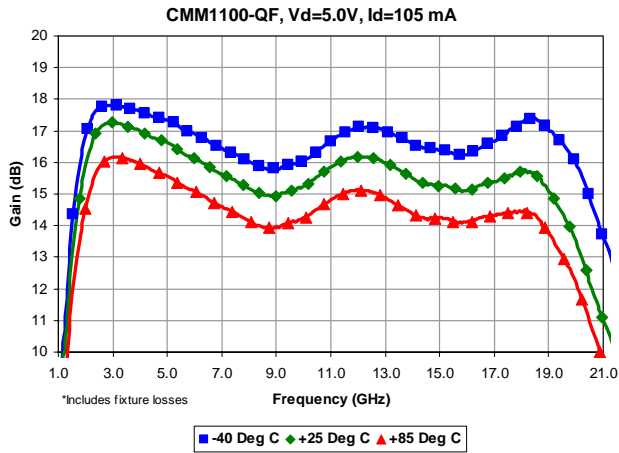

# 2.0-18.0 GHz GaAs MMIC Low Noise Amplifier, QFN



August 2009 - Rev 29-Aug-09

**CMM1100-QF**  
RoHS

## Low Noise Amplifier Measurements (cont.)

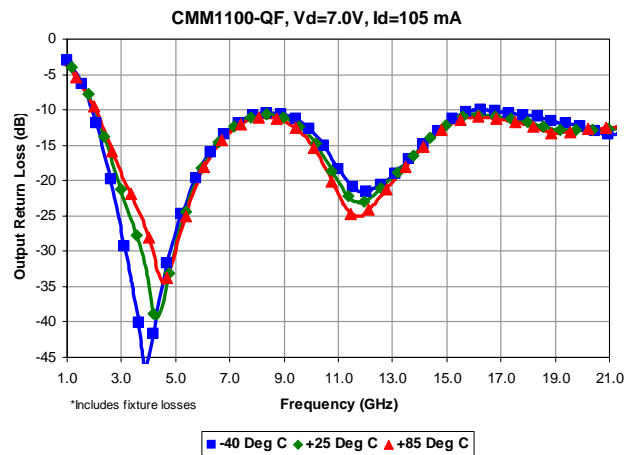
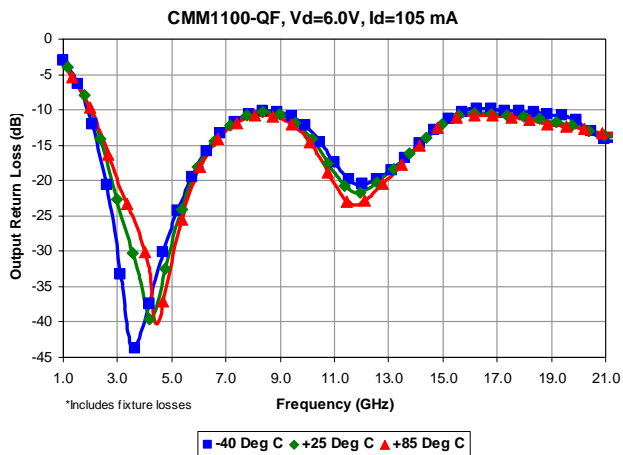
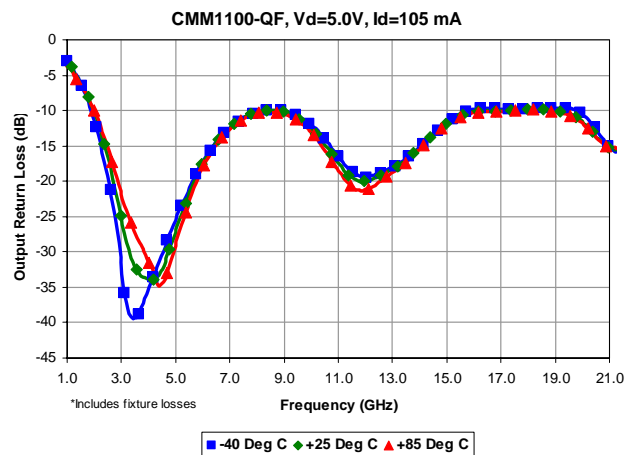
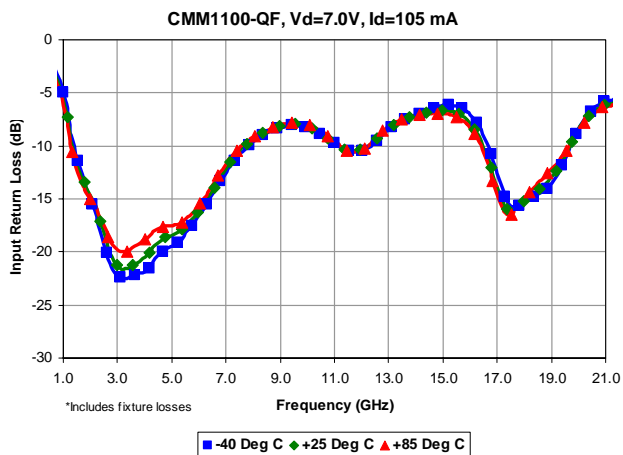
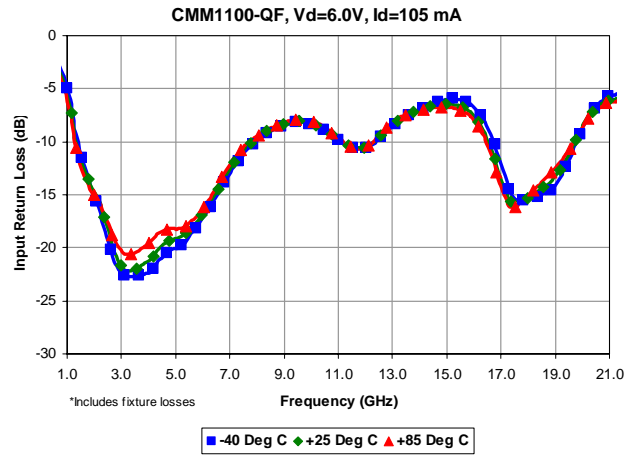
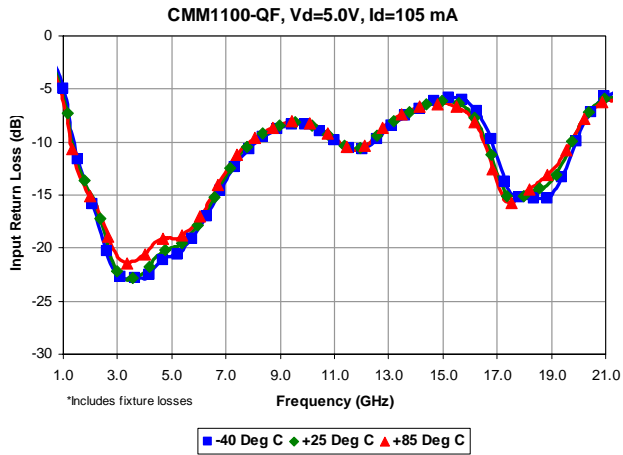

# 2.0-18.0 GHz GaAs MMIC Low Noise Amplifier, QFN



August 2009 - Rev 29-Aug-09

**CMM1100-QF**  
RoHS

## Low Noise Amplifier Measurements (cont.)

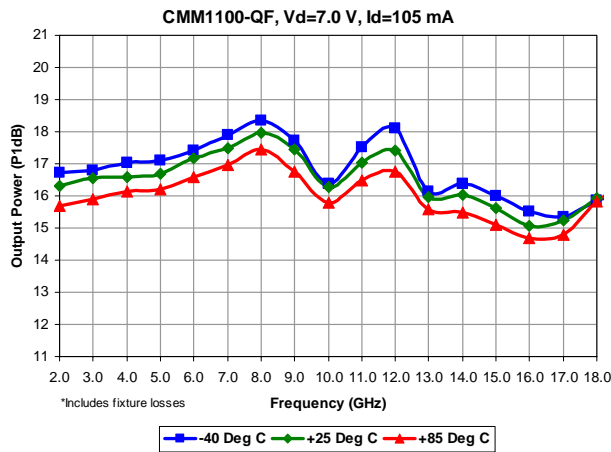
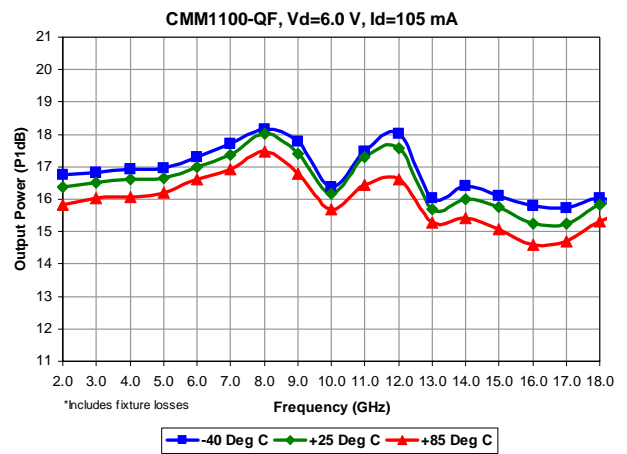
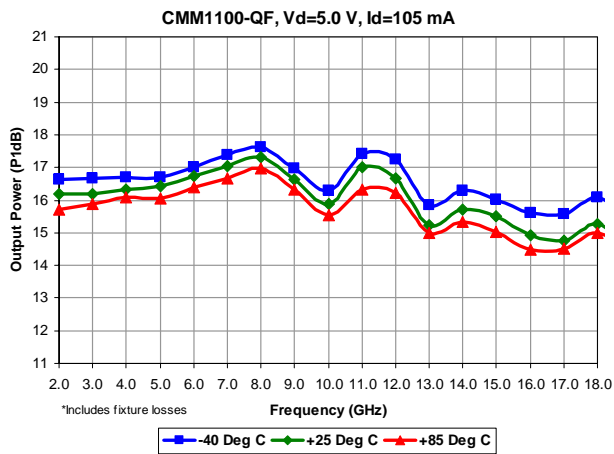
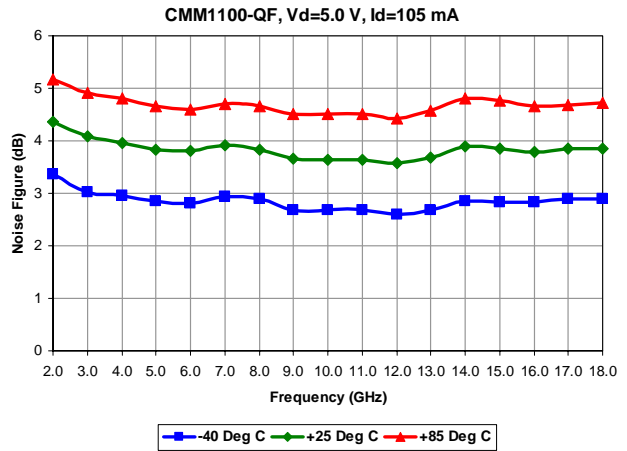
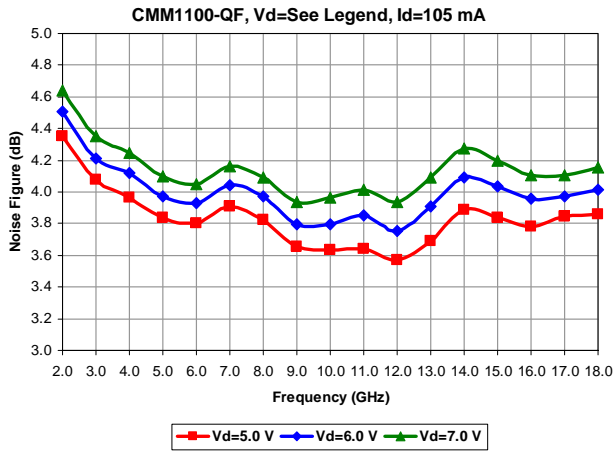

# 2.0-18.0 GHz GaAs MMIC Low Noise Amplifier, QFN



August 2009 - Rev 29-Aug-09

**CMM1100-QF**  
RoHS

## Low Noise Amplifier Measurements (cont.)

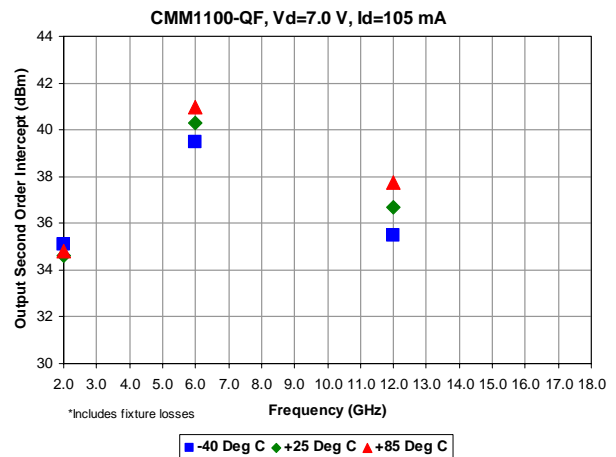
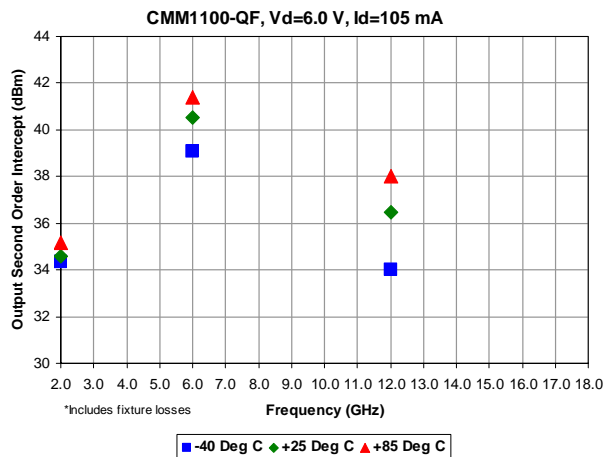
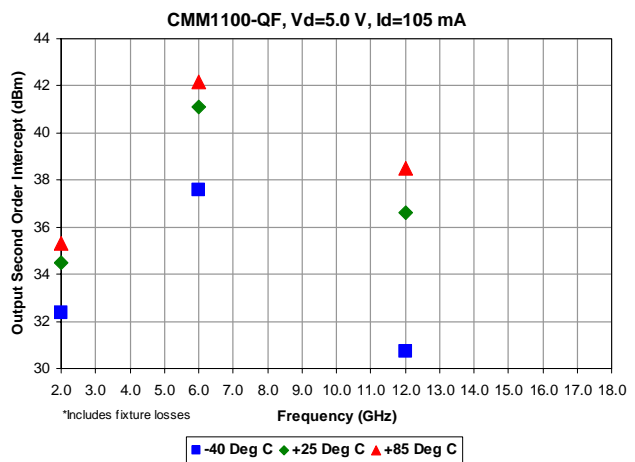
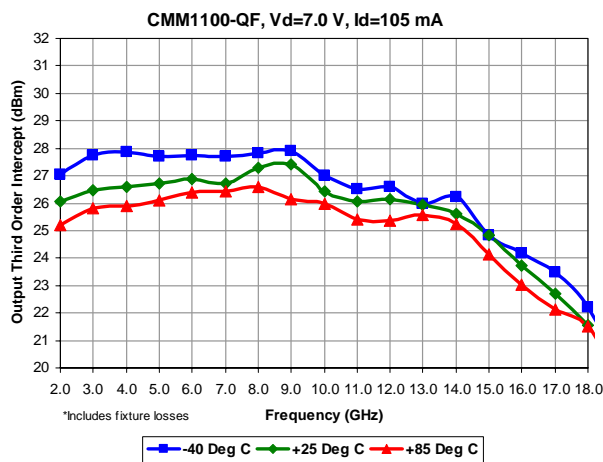
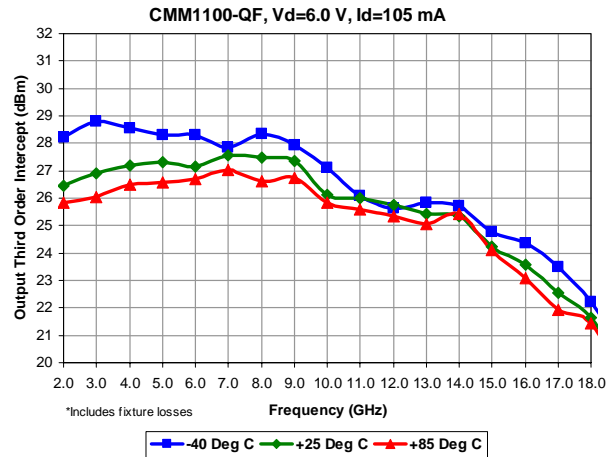
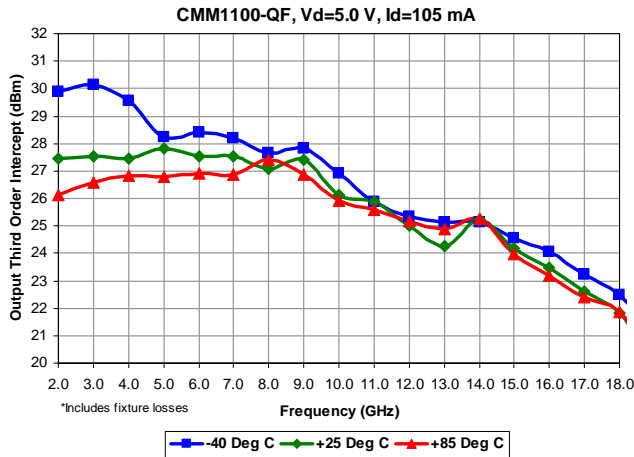

# 2.0-18.0 GHz GaAs MMIC Low Noise Amplifier, QFN

August 2009 - Rev 29-Aug-09

CMM1100-QF  
RoHS

## Package Dimensions/Layout QF

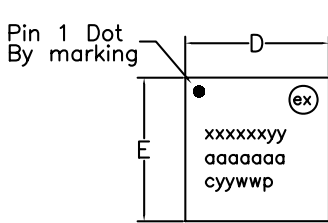

TOP VIEW

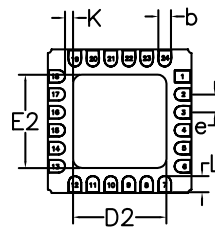
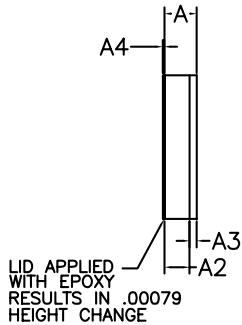

BOTTOM VIEW

Pin	Description
3	Ground
4	RF Input
5	Ground
11	Ground
12	Ground
14	Ground
15	RF Output
16	Ground
19	Vd

Note:

RECOMMENDED SOLDER PAD PITCH AND DIMENSIONS

1. ALL DIMENSIONS ARE IN mm.

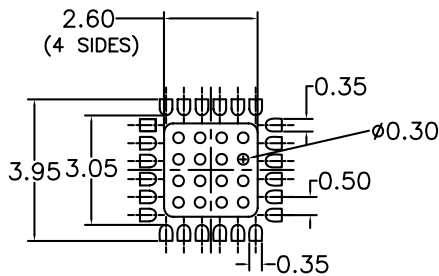

	MIN	TYP	MAX
A	0.55	0.60	.65
A2	0.00	0.40	.45
A3	0.20 REF		
A4	.010		
b	0.25	0.30	0.35
K	0.23	-	-
D	4.00 BSC		
E	4.00 BSC		
e	0.50		
D2	2.50	2.60	2.70
E2	2.50	2.60	2.70
L	0.40	0.45	0.50

## Functional Block Diagram/Board Layout

Bypass Capacitors - See App Note [2]

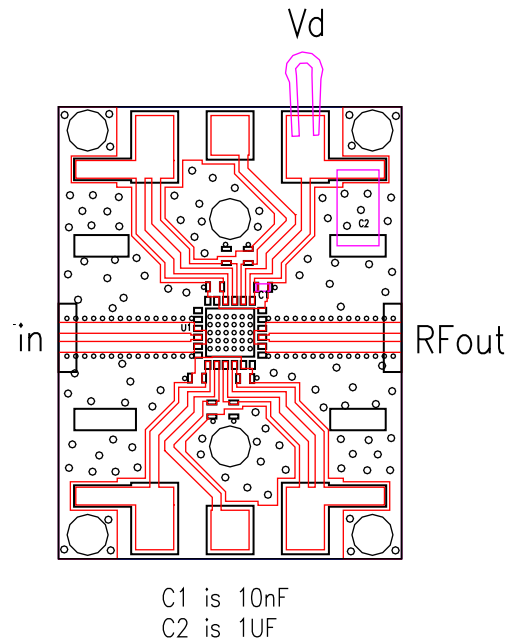
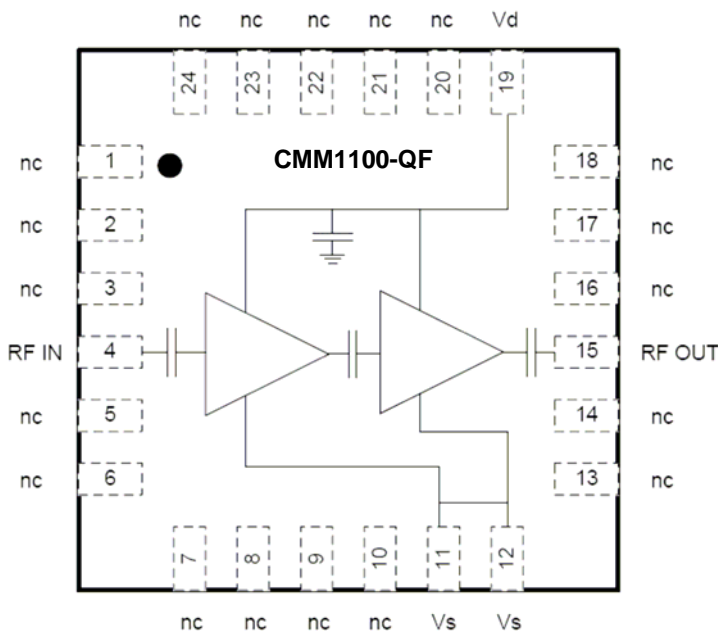

# 2.0-18.0 GHz GaAs MMIC Low Noise Amplifier, QFN

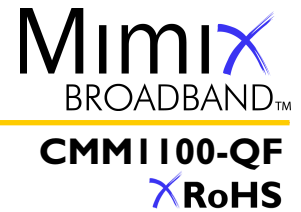

August 2009 - Rev 29-Aug-09

**App Note [1] Biasing** - This device operates using a self-biased architecture and only requires one drain bias. Bias is nominally  $V_d=5V$ ,  $I(\text{total})=100\text{ mA}$ .

**App Note [2] Bias Arrangement** - Each DC pad ( $V_d$ ) needs to have DC bypass capacitance ( $\sim 100\text{-}200\text{ pF}$ ) as close to the device as possible. Additional DC bypass capacitance ( $\sim 0.01\text{ uF}$ ) is also recommended.

## MTTF Graphs (TBD)

These numbers were calculated based on accelerated life test information and thermal model analysis received from the fabricating foundry.

# 2.0-18.0 GHz GaAs MMIC Low Noise Amplifier, QFN

August 2009 - Rev 29-Aug-09

## Handling and Assembly Information

**CAUTION!** - Mimix Broadband MMIC Products contain gallium arsenide (GaAs) which can be hazardous to the human body and the environment. For safety, observe the following procedures:

- Do not ingest.
- Do not alter the form of this product into a gas, powder, or liquid through burning, crushing, or chemical processing as these by-products are dangerous to the human body if inhaled, ingested, or swallowed.
- Observe government laws and company regulations when discarding this product. This product must be discarded in accordance with methods specified by applicable hazardous waste procedures.

**Life Support Policy** - Mimix Broadband's products are not authorized for use as critical components in life support devices or systems without the express written approval of the President and General Counsel of Mimix Broadband. As used herein: (1) Life support devices or systems are devices or systems which, (a) are intended for surgical implant into the body, or (b) support or sustain life, and whose failure to perform when properly used in accordance with instructions for use provided in the labeling, can be reasonably expected to result in a significant injury to the user. (2) A critical component is any component of a life support device or system whose failure to perform can be reasonably expected to cause the failure of the life support device or system, or to affect its safety or effectiveness.

**Package Attachment** - This packaged product from Mimix Broadband is provided as a rugged surface mount package compatible with high volume solder installation. Vacuum tools or other suitable pick and place equipment may be used to pick and place this part. Care should be taken to ensure that there are no voids or gaps in the solder connection so that good RF, DC and ground connections are maintained. Voids or gaps can eventually lead not only to RF performance degradation, but reduced reliability and life of the product due to thermal stress.

### Typical Reflow Profiles

Reflow Profile	SnPb	Pb Free
Ramp Up Rate	3-4 °C/sec	3-4 °C/sec
Activation Time and Temperature	60-120 sec @ 140-160 °C	60-180 sec @ 170-200 °C
Time Above Melting Point	60-150 sec	60-150 sec
Max Peak Temperature	240 °C	265 °C
Time Within 5 °C of Peak	10-20 sec	10-20 sec
Ramp Down Rate	4-6 °C/sec	4-6 °C/sec

### Factory Automation and Identification

Mimix Designator	Package Type	Number of leads offered	W Tape Width	P <sub>1</sub> Component Pitch	P <sub>0</sub> Hole Pitch	Reel Diameter	Units per Reel
-QF	QFN (4x4mm)	24	12mm	8mm	4mm	329mm (13in)	2000

Component Orientation: Parts are to be oriented with the PIN 1 closest to the tape's round sprocket holes on the tape's trailing edge.

Note: Tape and Reel packaging is ordered with a -000T suffix. Package is available in 2000 unit reels through designated sales channels. Minimum order quantities should be discussed with your local sales representative.

**Mimix Lead-Free RoHS Compliant Program** - Mimix has an active program in place to meet customer and governmental requirements for eliminating lead (Pb) and other environmentally hazardous materials from our products. All Mimix RoHS compliant components are form, fit and functional replacements for their non-RoHS equivalents. Lead plating of our RoHS compliant parts is 100% matte tin (Sn) over copper alloy and is backwards compatible with current standard SnPb low-temperature reflow processes as well as higher temperature (260°C reflow) "Pb Free" processes.

### Part Number for Ordering

CMM1100-QF-0N00  
CMM1100-QF-0N0T  
PB-CMM1100-QF-0000

We also offer this part with alternative plating options. Please contact your regional sales manager for more information regarding different plating types.

### Description

Gold plated RoHS compliant 4x4 24L QFN surface mount package in bulk quantity  
Gold plated RoHS compliant 4x4 24L QFN surface mount package in tape and reel  
CMM1100-QF evaluation board



Proper ESD procedures should be followed when handling this device.