



# SPN9507

## N-Channel Enhancement Mode MOSFET

### DESCRIPTION

The SPN9507 is the N-Channel logic enhancement mode power field effect transistors are produced using high cell density , DMOS trench technology.

This high density process is especially tailored to minimize on-state resistance.

These devices are particularly suited for low voltage application , notebook computer power management and other battery powered circuits where high-side switching .

### FEATURES

- ◆ 75V/60A,  $R_{DS(ON)} = 5.0m\Omega @ V_{GS} = 10V$
- ◆ Super high density cell design for extremely low  $R_{DS(ON)}$
- ◆ Exceptional on-resistance and maximum DC current capability
- ◆ TO-220-3L package design

### APPLICATIONS

- DC/DC Converter
- Load Switch
- SMPS Secondary Side Synchronous Rectifier

### PIN CONFIGURATION( TO-220-3L )

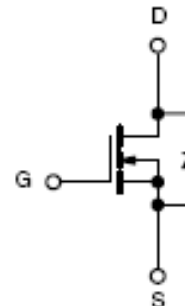
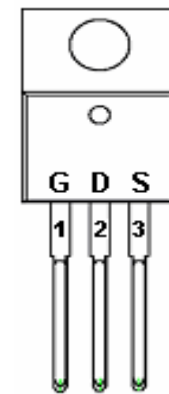

### PART MARKING

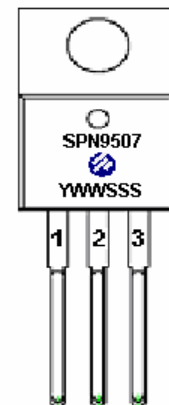

Y : Last Digit of The Year  
W : Week  
S : Sequence



# SPN9507

## N-Channel Enhancement Mode MOSFET

### PIN DESCRIPTION

Pin	Symbol	Description
1	G	Gate
2	D	Drain
3	S	Source

### ORDERING INFORMATION

Part Number	Package	Part Marking
SPN9507T220TGB	TO-220-3L	SPN9507

※ SPN9507T220TGB: Tube ; Pb – Free; Halogen – Free

### ABSOLUTE MAXIMUM RATINGS

( $T_A=25^{\circ}\text{C}$  Unless otherwise noted)

Parameter	Symbol	Typical	Unit	
Drain-Source Voltage	$V_{DSS}$	75	V	
Gate –Source Voltage	$V_{GSS}$	$\pm 20$	V	
Continuous Drain Current( $T_J=150^{\circ}\text{C}$ )	$I_D$	$T_A=25^{\circ}\text{C}$	80	A
		$T_A=70^{\circ}\text{C}$	70	
Pulsed Drain Current	$I_{DM}$	240	A	
Power Dissipation	$P_D$	$T_A=25^{\circ}\text{C}$	300	W
		$T_A=70^{\circ}\text{C}$	3.38	
Avalanche Energy with Single Pulse ( $T_J=25^{\circ}\text{C}$ , $L = 0.12\text{mH}$ , $I_{AS} = 80\text{A}$ , $V_{DD} = 60\text{V}$ .)	EAS	380	mJ	
Operating Junction Temperature	$T_J$	-55/150	$^{\circ}\text{C}$	
Storage Temperature Range	$T_{STG}$	-55/150	$^{\circ}\text{C}$	
Thermal Resistance-Junction to Ambient	$R_{\theta JA}$	2	$^{\circ}\text{C}/\text{W}$	



# SPN9507

## N-Channel Enhancement Mode MOSFET

### ELECTRICAL CHARACTERISTICS

(TA=25°C Unless otherwise noted)

Parameter	Symbol	Conditions	Min.	Typ	Max.	Unit
<b>Static</b>						
Drain-Source Breakdown Voltage	$V_{(BR)DSS}$	$V_{GS}=0V, I_D=250\mu A$	75			V
Gate Threshold Voltage	$V_{GS(th)}$	$V_{DS}=V_{GS}, I_D=250\mu A$	2.0		4.0	
Gate Leakage Current	$I_{GSS}$	$V_{DS}=0V, V_{GS}=\pm 20V$			$\pm 100$	nA
Zero Gate Voltage Drain Current	$I_{DSS}$	$V_{DS}=75V, V_{GS}=0V$			10	uA
		$V_{DS}=60V, V_{GS}=0V$ $T_J = 150^\circ C$			250	
Drain-Source On-Resistance	$R_{DS(on)}$	$V_{GS} = 10V, I_D=60A$			5.0	mΩ
Forward Transconductance	$g_{fs}$	$V_{DS}=10V, I_D=60A$		57		S
Diode Forward Voltage	$V_{SD}$	$I_S=60A, V_{GS} = 0V$			1.3	V
<b>Dynamic</b>						
Total Gate Charge	$Q_g$	$V_{DS}=40V, V_{GS}=10V$ $I_D= 80A$		85	135	nC
Gate-Source Charge	$Q_{gs}$			25		
Gate-Drain Charge	$Q_{gd}$			36		
Input Capacitance	$C_{iss}$	$V_{DS}=25V, V_{GS}=0V$ $f=1MHz$		4290	6870	pF
Output Capacitance	$C_{oss}$			985		
Reverse Transfer Capacitance	$C_{rss}$			390		
Turn-On Time	$t_{d(on)}$	$V_{DD}=40V, R_L=0.5\Omega$ $I_D=80A, V_{GEN}=10V$ $R_G=3.3\Omega$		22		nS
	$t_r$			160		
Turn-Off Time	$t_{d(off)}$			38		
	$t_f$			165		



# SPN9507 N-Channel Enhancement Mode MOSFET

## TYPICAL CHARACTERISTICS

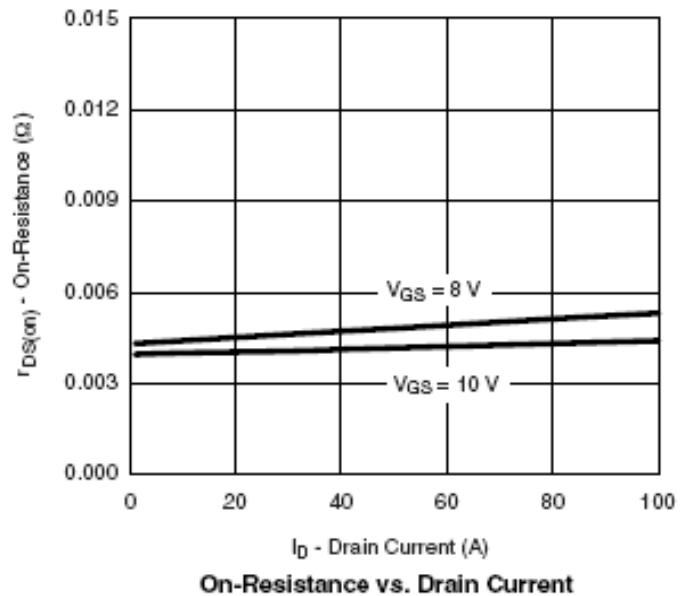
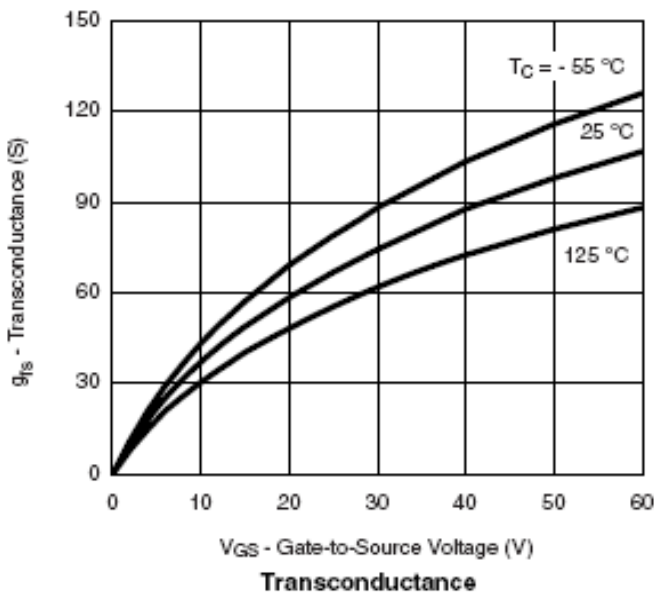
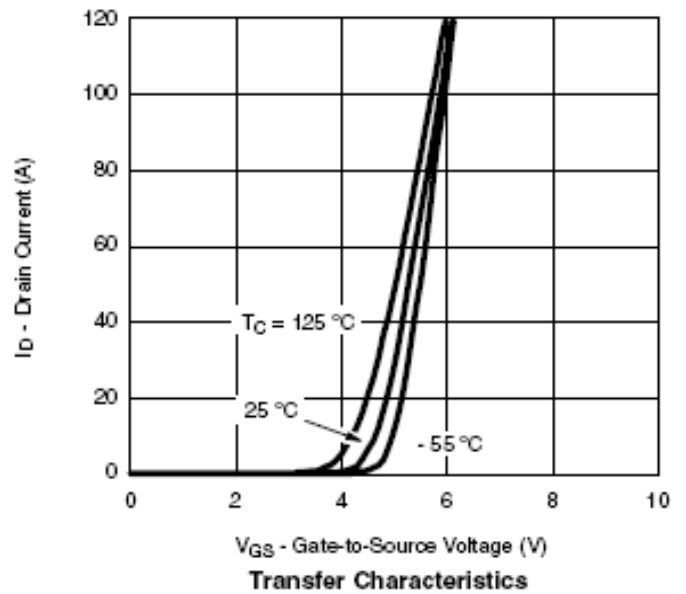
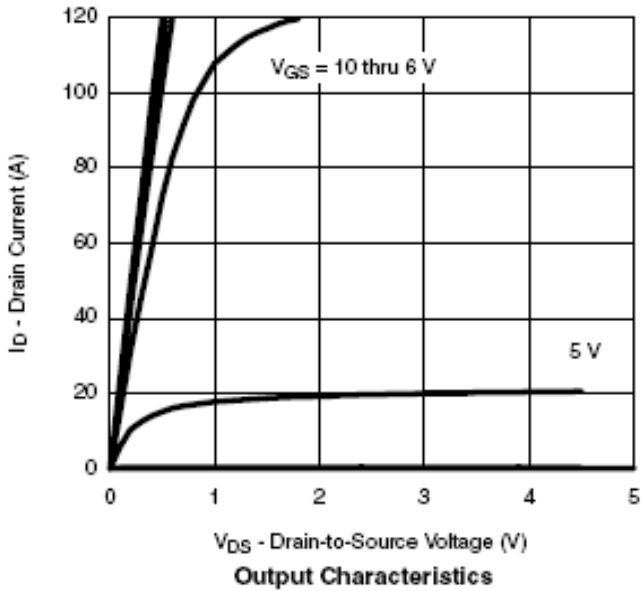



# SPN9507 N-Channel Enhancement Mode MOSFET

## TYPICAL CHARACTERISTICS

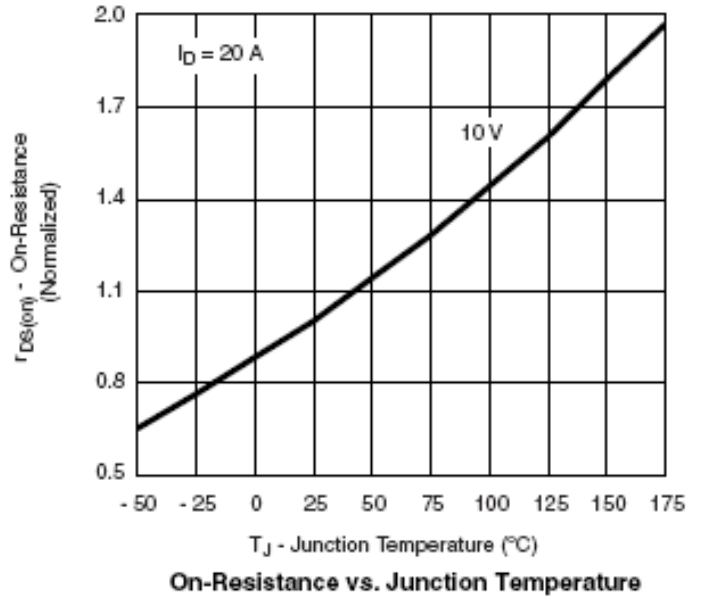
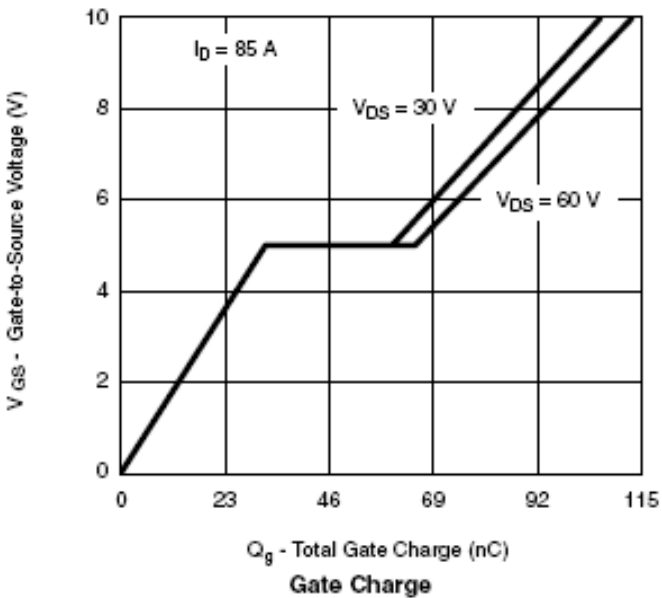
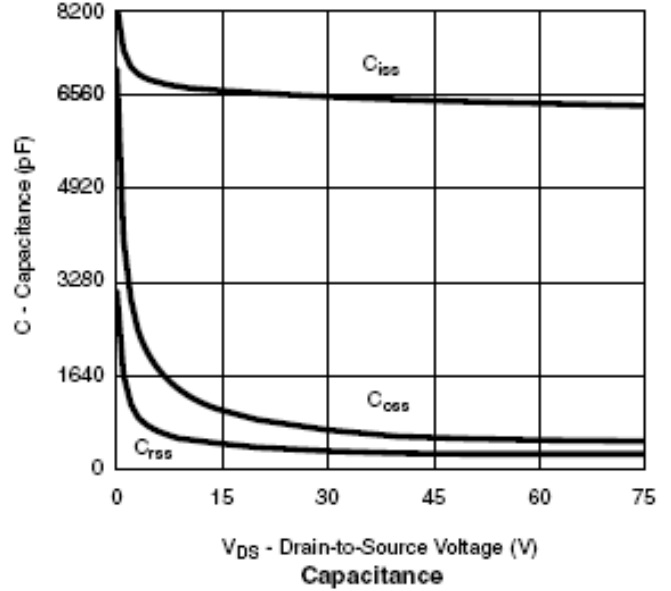
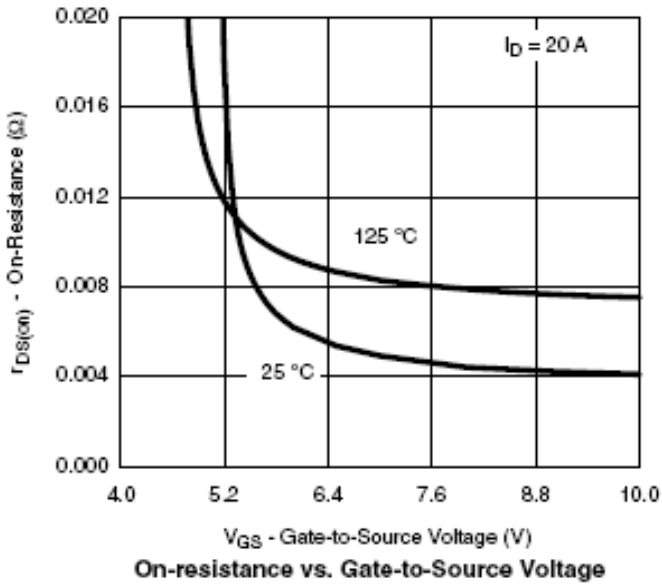



# SPN9507 N-Channel Enhancement Mode MOSFET

## TYPICAL CHARACTERISTICS

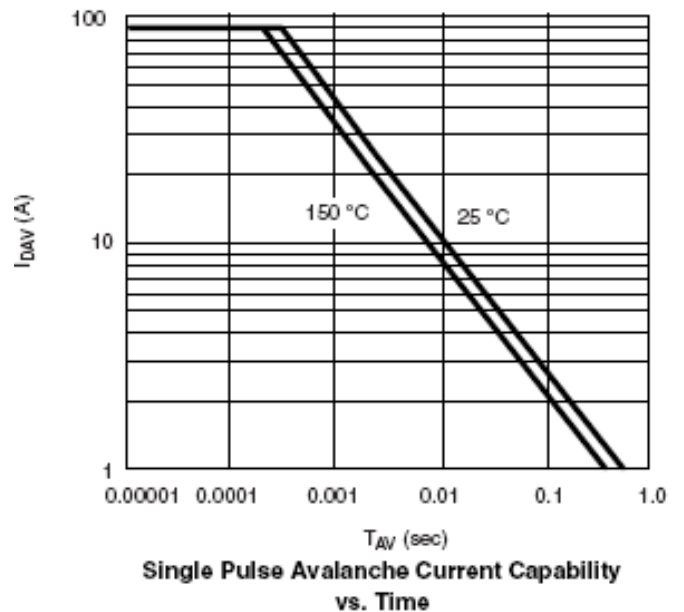
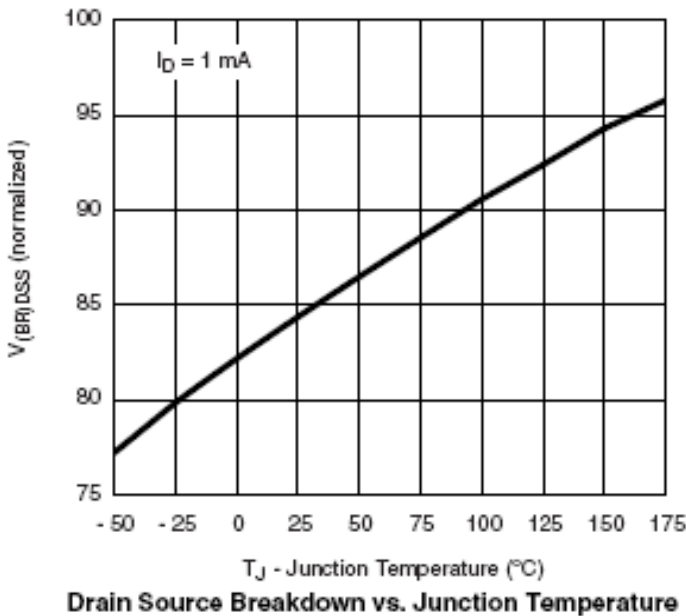
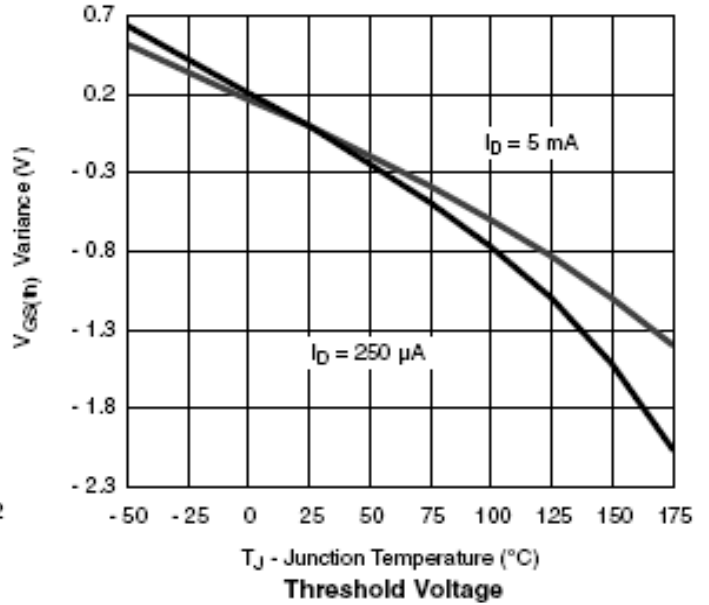
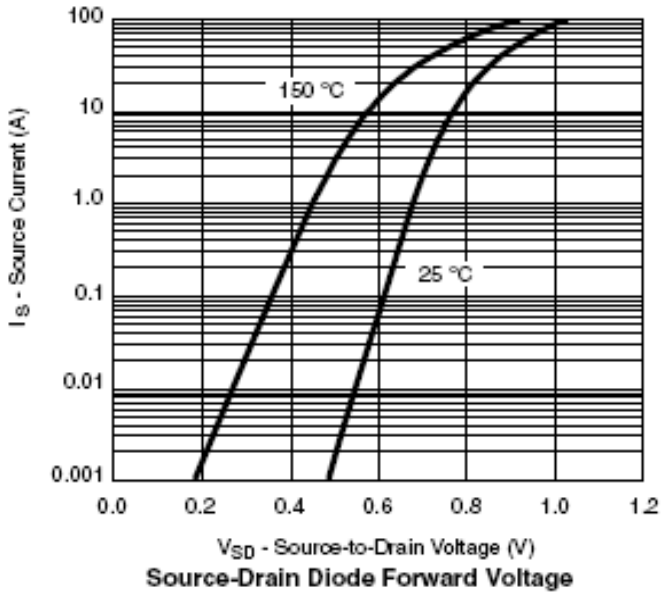



# SPN9507 N-Channel Enhancement Mode MOSFET

## TYPICAL CHARACTERISTICS

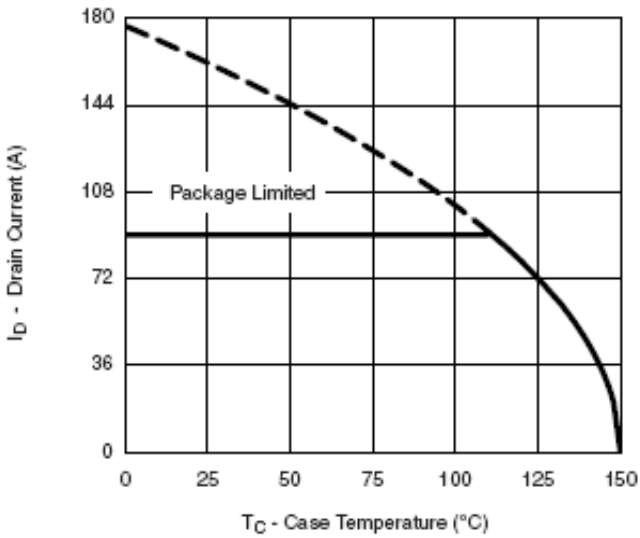

Maximum Drain Current vs. Case Temperature

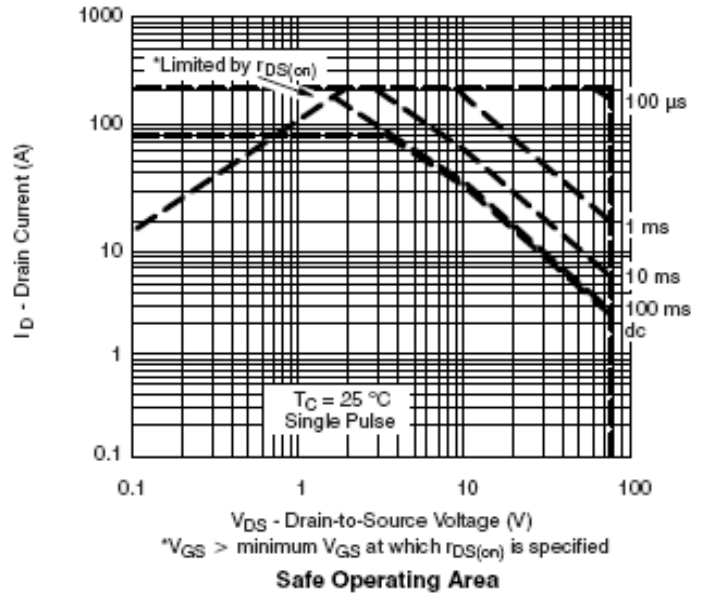

Safe Operating Area

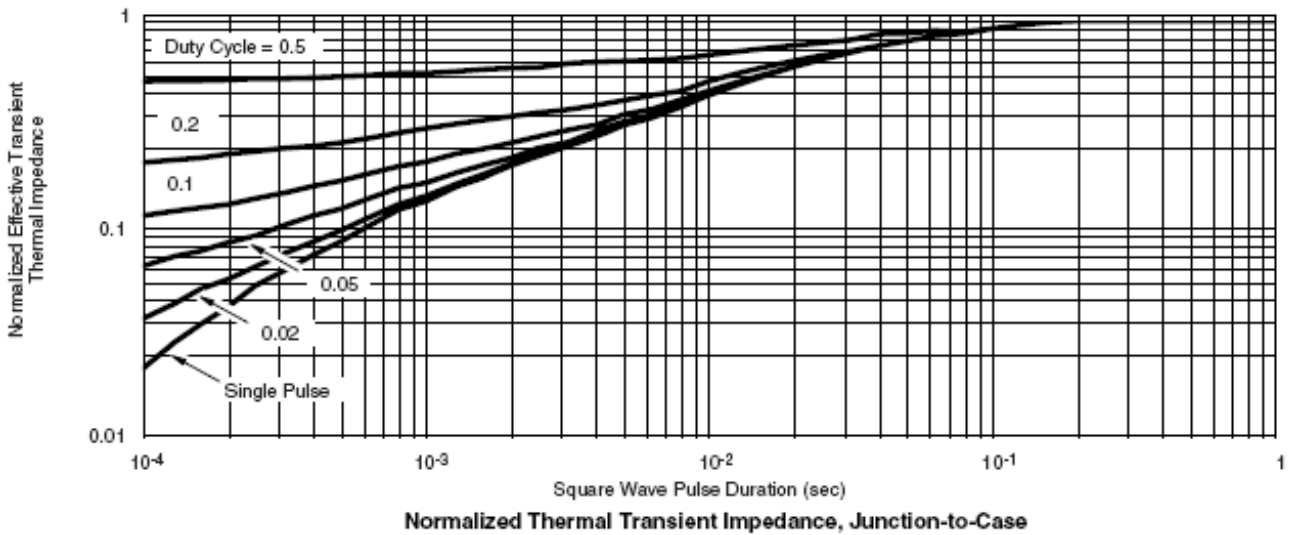

Normalized Thermal Transient Impedance, Junction-to-Case



# SPN9507

## N-Channel Enhancement Mode MOSFET

### TO-220-3L PACKAGE OUTLINE

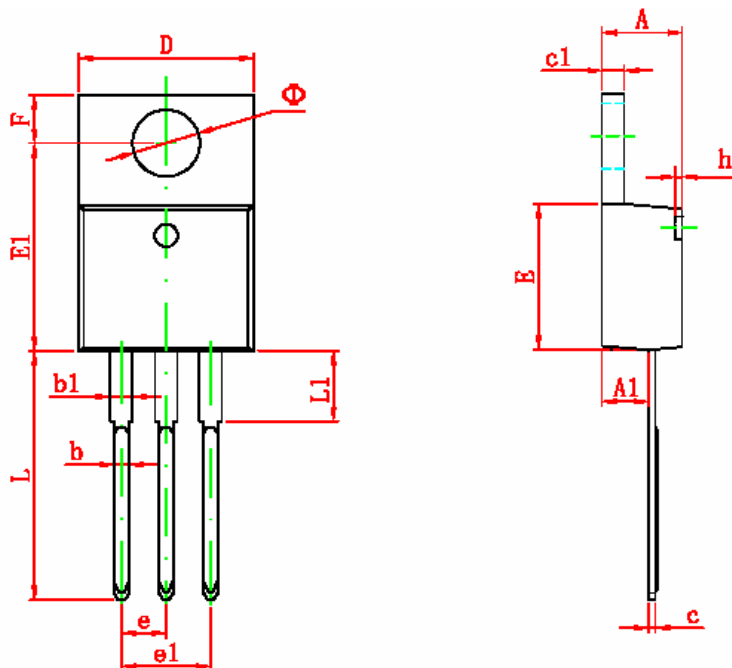

Symbol	Dimensions In Millimeters		Dimensions In Inches	
	Min	Max	Min	Max
A	4.470	4.670	0.176	0.184
A1	2.520	2.820	0.099	0.111
b	0.710	0.910	0.028	0.036
b1	1.170	1.370	0.046	0.054
c	0.310	0.530	0.012	0.021
c1	1.170	1.370	0.046	0.054
D	10.010	10.310	0.394	0.406
E	8.500	8.900	0.335	0.350
E1	12.060	12.460	0.475	0.491
e	2.540 TYP		0.100 TYP	
e1	4.980	5.180	0.196	0.204
F	2.590	2.890	0.102	0.114
h	0.000	0.300	0.000	0.012
L	13.400	13.800	0.528	0.543
L1	3.560	3.960	0.140	0.156
• •	3.735	3.935	0.147	0.155





# SPN9507

## N-Channel Enhancement Mode MOSFET

---

Information provided is alleged to be exact and consistent. SYNC Power Corporation presumes no responsibility for the penalties of use of such information or for any violation of patents or other rights of third parties which may result from its use. No license is granted by allegation or otherwise under any patent or patent rights of SYNC Power Corporation. Conditions mentioned in this publication are subject to change without notice. This publication surpasses and replaces all information previously supplied. SYNC Power Corporation products are not authorized for use as critical components in life support devices or systems without express written approval of SYNC Power Corporation.

©The SYNC Power logo is a registered trademark of SYNC Power Corporation

©2004 SYNC Power Corporation – Printed in Taiwan – All Rights Reserved

SYNC Power Corporation

9F-5, No.3-2, Park Street

NanKang District (NKSP), Taipei, Taiwan 115

Phone: 886-2-2655-8178

Fax: 886-2-2655-8468

©<http://www.syncpower.com>