



LIGITEK ELECTRONICS CO.,LTD.
Property of Ligitek Only

LED ARRAY



Lead-Free Parts

LA38B-73/DGL-PF

DATA SHEET

DOC. NO : QW0905-LA38B-73/DGL-PF

REV. : A

DATE : 22 - Nov. - 2005



Package Dimensions

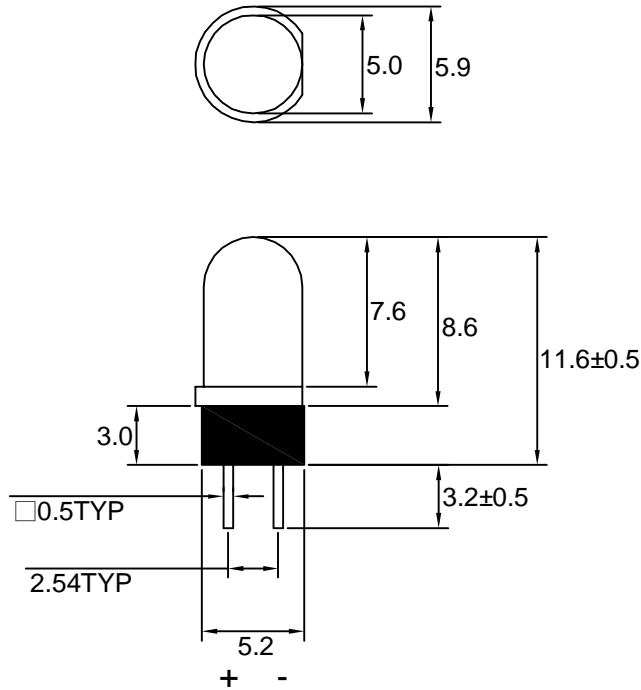

LDGL3333

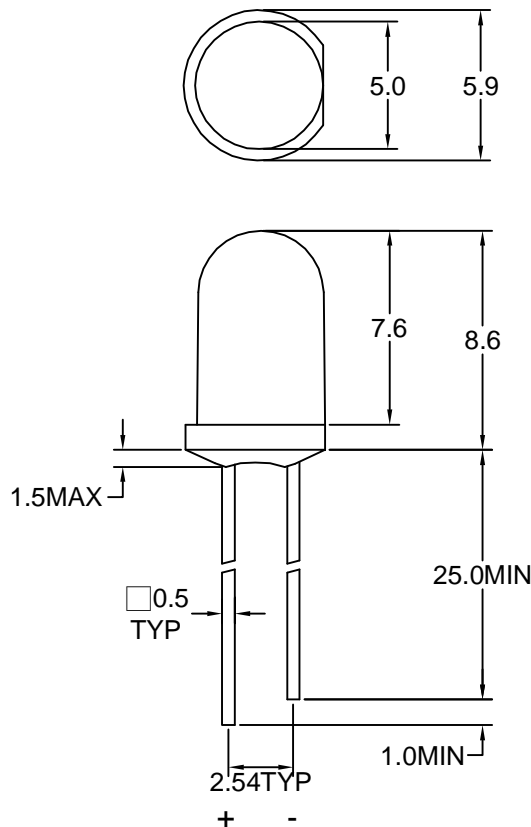

Note : 1.All dimension are in millimeter tolerance is ±0.25mm unless otherwise noted.
2.Specifications are subject to change without not



Absolute Maximum Ratings at Ta=25 °C

Parameter	Symbol	Ratings	UNIT
		DGL	
Forward Current	IF	30	mA
Peak Forward Current Duty 1/10@10KHz	IFP	100	mA
Power Dissipation	PD	120	mW
Reverse Current @5V	Ir	50	μ A
Electrostatic Discharge(*)	ESD	150	V
Operating Temperature	Topr	-20 ~ +80	°C
Storage Temperature	Tstg	-30 ~ +100	°C

* Static Electricity or power surge will damage the LED. Use of a conductive wrist band or anti-electrosatic glove is recommended when handing these LED. All devices, equipment and machinery must be properly grounded.

Typical Electrical & Optical Characteristics (Ta=25 °C)

PART NO	MATERIAL	COLOR		Dominant wave length λ D nm	Spectral halfwidth Δ λ nm	Forward voltage @20mA(V)		Luminous intensity @20mA(mcd)		Viewing angle 2θ 1/2 (deg)
		Emitted	Lens			Typ.	Max.	Min.	Typ.	
LA38B-73/DGL-PF	InGaN/GaN	Green	Water Clear	505	32	3.5	4.0	6200	11500	13

Note : 1.The forward voltage data did not including ±0.1V testing tolerance.
2. The luminous intensity data did not including ±15% testing tolerance.



Typical Electro-Optical Characteristics Curve

DGL CHIP

Fig.1 Forward current vs. Forward Voltage

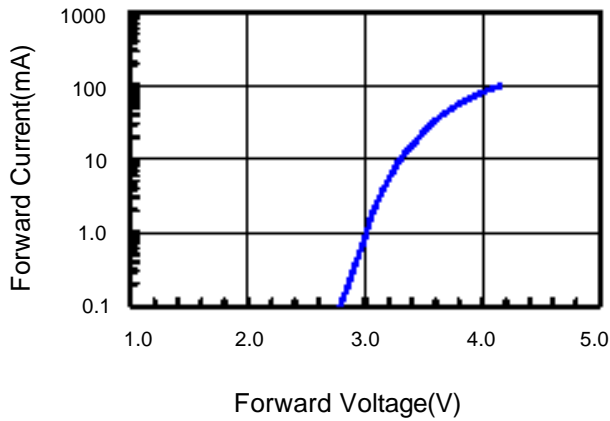

Fig.2 Relative Intensity vs. Forward Current

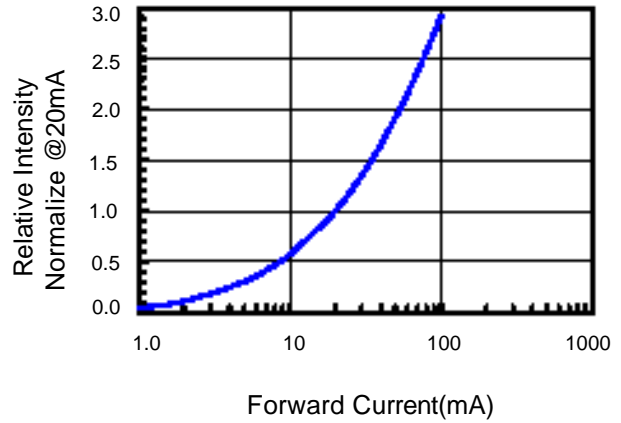

Fig.3 Forward Voltage vs. Temperature

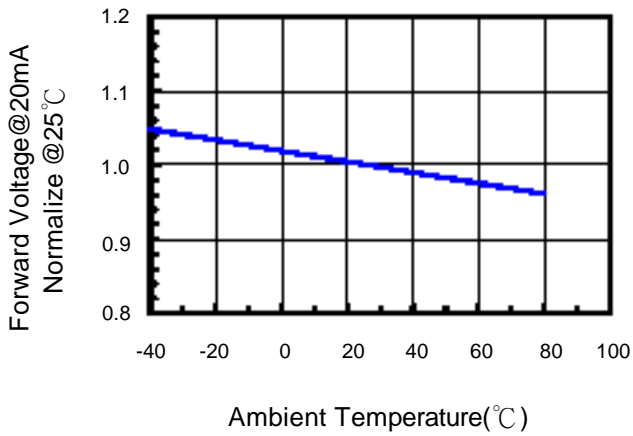

Fig.4 Relative Intensity vs. Temperature

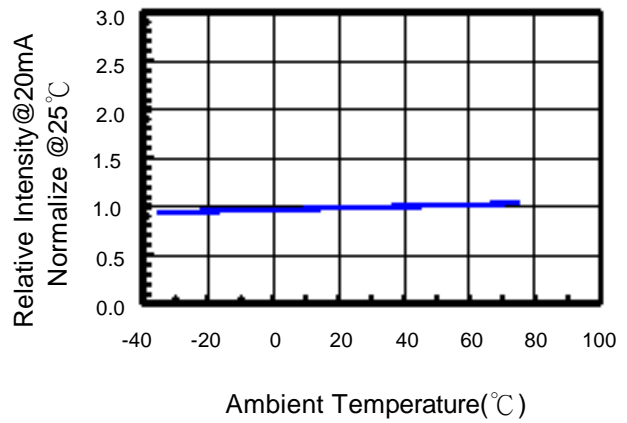
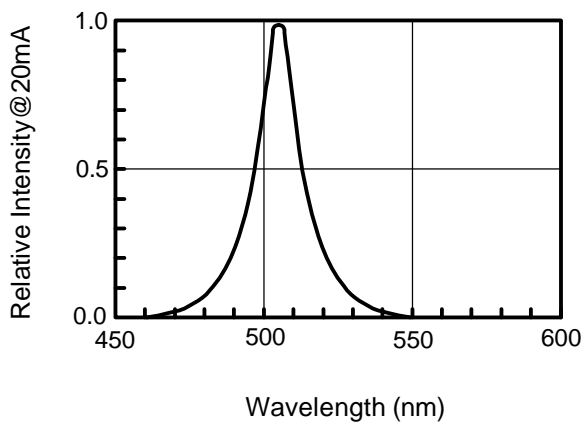

Fig.5 Relative Intensity vs. Wavelength





Soldering Condition(Pb-Free)

1.Iron:

- Soldering Iron:30W Max
- Temperature 350° C Max
- Soldering Time:3 Seconds Max(One Time)
- Distance:2mm Min(From solder joint to case)

2.Wave Soldering Profile

- Dip Soldering
- Preheat: 120° C Max
- Preheat time: 60seconds Max
- Ramp-up
- 2° C/sec(max)
- Ramp-Down:-5° C/sec(max)
- Solder Bath:260° C Max
- Dipping Time:3 seconds Max
- Distance:2mm Min(From solder joint to case)

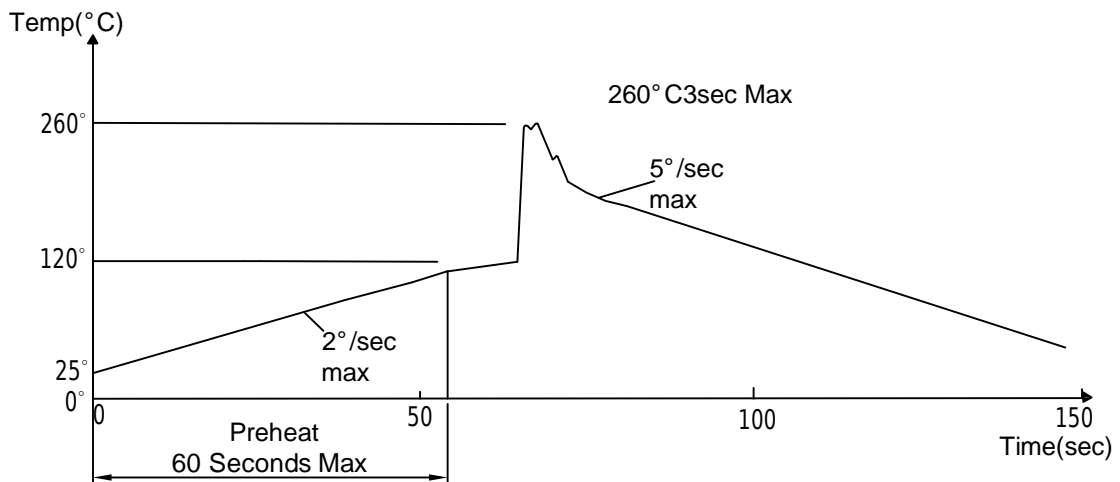



Reliability Test:

Test Item	Test Condition	Description	Reference Standard
Operating Life Test	1.Under Room Temperature 2.If=20mA 3.t=1000 hrs (-24hrs, +72hrs)	This test is conducted for the purpose of determining the resistance of a part in electrical and thermal stressed.	MIL-STD-750: 1026 MIL-STD-883: 1005 JIS C 7021: B-1
High Temperature Storage Test	1.Ta=105 °C ±5°C 2.t=1000 hrs (-24hrs, +72hrs)	The purpose of this is the resistance of the device which is laid under condition of high temperature for hours.	MIL-STD-883:1008 JIS C 7021: B-10
Low Temperature Storage Test	1.Ta=-40 °C ±5°C 2.t=1000 hrs (-24hrs, +72hrs)	The purpose of this is the resistance of the device which is laid under condition of low temperature for hours.	JIS C 7021: B-12
High Temperature High Humidity Test	1.Ta=65 °C ±5°C 2.RH=90%~95% 3.t=240hrs ±2hrs	The purpose of this test is the resistance of the device under tropical for hours.	MIL-STD-202:103B JIS C 7021: B-11
Thermal Shock Test	1.Ta=105 °C ±5°C & -40 °C ±5°C (10min) (10min) 2.total 10 cycles	The purpose of this is the resistance of the device to sudden extreme changes in high and low temperature.	MIL-STD-202: 107D MIL-STD-750: 1051 MIL-STD-883: 1011
Solder Resistance Test	1.T.Sol=260 °C ±5°C 2.Dwell time= 10 ±1sec.	This test intended to determine the thermal characteristic resistance of the device to sudden exposures at extreme changes in temperature when soldering the lead wire.	MIL-STD-202: 210A MIL-STD-750: 2031 JIS C 7021: A-1
Solderability Test	1.T.Sol=230 °C ±5°C 2.Dwell time=5 ±1sec	This test intended to see soldering well performed or not.	MIL-STD-202: 208D MIL-STD-750: 2026 MIL-STD-883: 2003 JIS C 7021: A-2