



NMC6164AN/6164AN-L 8192 x 8-Bit Static RAM

March 1987

General Description

The NMC6164A/6164AN-L is an 8192 by 8-bit, new generation, static RAM. It is fabricated with National's proprietary microCMOS double-polysilicon technology which combines high performance and high density with low power consumption and excellent reliability.

The NMC6164A/6164AN-L operates with a single 5V power supply with $\pm 10\%$ tolerance. Additional battery back-up operation is available (L version) for data retention down to 2V, with low standby current.

Packaging is available in standard 28-pin plastic DIP.

In addition to the inputs and outputs being TTL compatible, the outputs are also CMOS compatible, in that capacitive loads are driven to V_{CC} or V_{SS} .

Features

- Single power supply: $5V \pm 10\%$
- Fast access time 45 ns/55 ns/70 ns max
- Equal access and cycle times
- Completely static RAM: no clock or timing strobe required
- Low standby power and low power operation
Standby: $10 \mu W$, typical
Operation: 10 mW/MHz , typical
- Battery back-up operation available (L version) with data retention supply voltage: 2V–5.5V
- Common data input and output, TRI-STATE® output
- TTL compatible: all inputs and outputs
- CMOS compatible: outputs drive capacitive loads to V_{CC} or V_{SS}
- Standard 28-pin package configuration

Block and Connection Diagrams

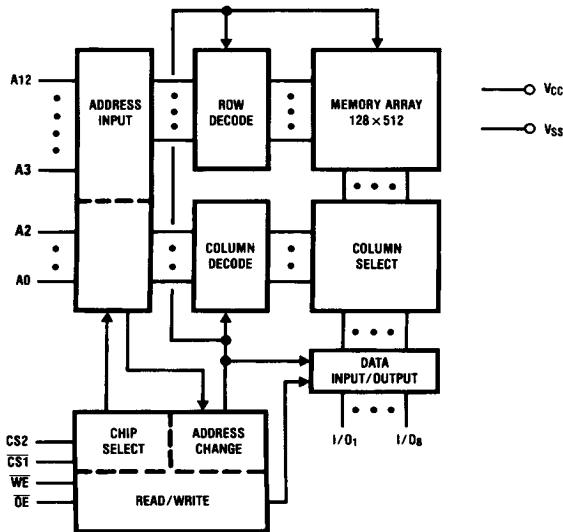

Dual-In-Line Package

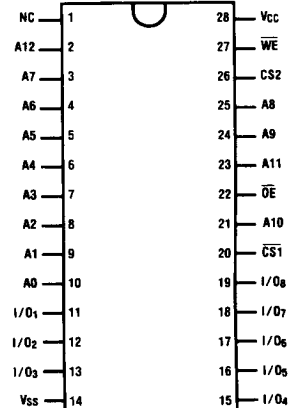

Top View TL/D/8808-2

Order Number **NMC6164AN**
or **NMC6164AN-L**
See NS Package Number **N28B**

TL/D/8808-1

Order Number	NMC6164AN-45L	NMC6164AN-45	NMC6164AN-55L	NMC6164AN-55	NMC6164AN-70L	NMC6164AN-70
Parameter						
Access Time (ns)	45	45	55	55	70	70
I_{CC} Standby, CMOS	$100 \mu A$	2 mA	$100 \mu A$	2 mA	$100 \mu A$	2 mA

Absolute Maximum Ratings

If Military/Aerospace specified devices are required, contact the National Semiconductor Sales Office/Distributors for availability and specifications.

Voltage on Any Pin Relative to V _{SS}	-0.6V to +7V
Storage Temperature, T _{STG}	-55°C to +125°C
Temperature Under Bias, T _{BIAS}	-10°C to +85°C
Power Dissipation, P _D	1.0W
Current Through Any Pin	100 mA
ESD rating to be determined.	

Recommended DC Operating Conditions

	Min	Max	Units
V _{CC} Supply Voltage	4.5	5.5	V
V _{SS} Supply Voltage	0	0	V
V _{IH} , Input High Voltage (Logic 1)			
TTL	2.2	6.0	V
CMOS	V _{CC} - 0.2	V _{CC} + 0.2	V
V _{IL} , Input Low Voltage (Logic 0)			
TTL	-0.3	0.8	V
CMOS	-0.3	0.2	V
T _{OPR} , Operating Temp	0	70	°C

DC Electrical Characteristics at recommended operating conditions

Symbol	Parameter	Conditions	Min	Max	Units
I _{LI}	Input Leakage Current	V _{IN} = V _{SS} to V _{CC}	-2	2	μA
I _{LO}	Output Leakage Current	$\overline{CS1} = V_{IH}$ or CS2 = V _{IL} or $\overline{OE} = V_{IH}$ V _{I/O} = V _{SS} to V _{CC}	-2	2	μA
I _{CC}	Active Quiescent Current, TTL	All Inputs at TTL Levels		25	mA
I _{CC}	Active Quiescent Current, CMOS	All Inputs at CMOS Levels		2	mA
				100	μA
I _{CC1}	Average Operating Current, TTL	t _{RC} = t _{RC} Min CS1 = V _{IL} TTL and CS2 = V _{IH} TTL I _{I/O} = 0 mA All Inputs at TTL Levels		50	mA
	Average Operating Current, CMOS	t _{RC} = t _{RC} Min CS1 = V _{IL} CMOS and CS2 = V _{IH} CMOS I _{I/O} = 0 mA All Inputs at CMOS Levels		30	mA
I _{SB}	Std L	Standby Power Supply Current	CS1 = V _{IH} TTL or CS2 = V _{IL} TTL	4	mA
				2	mA
I _{SB1}	Std L	Standby Power Supply Current	CS1 = V _{IH} CMOS or CS2 = V _{IL} CMOS	2	mA
				100	μA
V _{OL}	Std L	Output Low Voltage, TTL	I _{OL} = 8 mA	0.4	V
		Output Low Voltage, CMOS	I _{OL} = ±10 μA	-0.2	0.2
V _{OH}	Std L	Output High Voltage, TTL	I _{OH} = -4.0 mA	2.4	V
		Output High Voltage, CMOS	I _{OH} = ±10 μA	V _{CC} - 0.2	V _{CC} + 0.2

Capacitance

Symbol	Parameter	Conditions	Max	Units
C _{IN}	Input Capacitance	V _{IN} = 0V (Note 5)	8	pF
C _{I/O}	Input/Output Capacitance	V _{I/O} = 0V (Note 5)	10	pF

Truth Table

Mode	\overline{WE}	$\overline{CS1}$	CS2	\overline{OE}	I/O	Current
Not Selected (Power Down)	*	H	*	*	Hi-Z	I _{SB} , I _{SB1}
	*	*	L	*	Hi-Z	I _{SB} , I _{SB1}
Output Disabled	H	L	H	H	Hi-Z	I _{CC} , I _{CC1}
Read	H	L	H	L	D _{OUT}	I _{CC} , I _{CC1}
Write	L	L	H	*	D _{IN}	I _{CC} , I _{CC1}

*Don't Care (H or L) H = Logic HIGH Level L = Logic LOW Level

AC Electrical Characteristics* (Note 1)

Symbol	Parameter	NMC6164AN/6164AN-L						Units
		-45		-55		-70		
		Min	Max	Min	Max	Min	Max	
READ CYCLE (Note 4)								
t _{RC}	Read Cycle Time	45		55		70		ns
t _{AA}	Address Access Time		45		55		70	ns
t _{CO1}	Chip Selection (CS1) to Output Valid		45		55		70	ns
t _{CO2}	Chip Selection (CS2) to Output Valid		45		55		70	ns
t _{OE}	Output Enable (OE) to Output Valid		20		25		30	ns
t _{LZ1}	Chip Selection (CS1) to Output Active (Note 12)	15		15		15		ns
t _{LZ2}	Chip Selection (CS2) to Output Active (Note 12)	15		15		15		ns
t _{OLZ}	Output Enable (OE) to Output Active (Note 12)	5		5		5		ns
t _{HZ1}	Chip Deselection (CS1) to Output in Hi-Z (Notes 2 and 3)	0	20	0	25	0	30	ns
t _{HZ2}	Chip Deselection (CS2) to Output in Hi-Z (Notes 2 and 3)	0	20	0	25	0	30	ns
t _{OHZ}	Output Disable (OE) to Output in Hi-Z (Notes 2 and 3)	0	15	0	20	0	25	ns
t _{OHA}	Output Hold from Address Change	5		5		5		ns
WRITE CYCLE								
t _{WC}	Write Cycle Time	45		55		70		ns
t _{CW1}	Chip Selection (CS1) to End of Write (Note 10)	40		50		60		ns
t _{CW2}	Chip Selection (CS2) to End of Write	40		50		60		ns
t _{AS}	Address Setup Time (Note 7)	0		0		0		ns
t _{AW}	Address Valid to End of Write	40		50		60		ns
t _{WP}	Write Pulse Width (Note 6)	35		40		50		ns
t _{WR1}	Write Recovery Time from CS1 (Note 8)	0		0		0		ns
t _{WR2}	Write Recovery Time from CS2 (Note 8)	0		0		0		ns
t _{WHZ}	Beginning of Write to Output in Hi-Z (Note 9)	0	15	0	20	0	25	ns
t _{DW}	Data Valid to Write Time Overlap	20		25		35		ns
t _{DH}	Data Hold from End of Write	0		0		0		ns
t _{OHZ}	Output Disable (OE) to Output in Hi-Z	0	15	0	20	0	25	ns
t _{OW}	Output Active from End of Write	0		0		0		ns

*Applies to Standard and L Versions.

Note 1: AC test conditions T_A = 0°C to +70°C, V_{CC} = 5V ± 10%.

Note 2: t_{HZ} and t_{OHZ} are defined as the time at which the outputs achieve the open circuit condition and are determined as:
 High to TRI-STATE, measured V_{OH} (DC) - 0.10V
 Low to TRI-STATE, measured V_{OL} (DC) + 0.10V

Note 3: At any given temperature and voltage condition, t_{HZ} MAX is less than t_{LZ} MIN, both for a given device and from device to device (guaranteed, not tested).

Note 4: WE is high for read cycle.

Note 5: T_A = 25°C, f = 1.0 MHz. This parameter is sampled and not 100% tested.

Note 6: A write occurs during the overlap (t_{WP}) of a low CS1 and a high CS2 and a low WE.

Note 7: t_{AS} is measured from the address changes to the beginning of the write.

Note 8: t_{WR} is measured from the earliest of CS1 or WE going high or CS2 going low to the end of the write cycle.

Note 9: If CS1 is low and CS2 is high during this period, I/O pins are in the output state. At this time, the data input signals of opposite phase to the outputs must not be applied.

Note 10: If the CS1 low transition occurs simultaneously with the WE low transition or after the WE transition, the outputs will remain in a Hi-Z state.

Note 11: CS2 controls the address buffers, WE buffer, CS1 buffer, D_{IN} buffer and OE buffer. When CS2 controls the data retention mode, all inputs (address, I/O, WE, CS1, OE) can be in the high impedance state. When CS1 controls the data retention mode, CS2 must be at V_{IH}, CMOS. All other input levels (address, OE, WE, I/O) can be in the high impedance state.

Note 12: Output active level is defined as steady state TRI-STATE level ± 0.1V.

AC Test Conditions

Input pulse levels V_{IH} = 3.0V, V_{IL} = 0.0V
 Input rise and fall times 5 ns
 All Input timing reference levels 1.5V
 Output timing reference levels V_{OH} = 2.0V, V_{OL} = 0.8V

AC Test Load

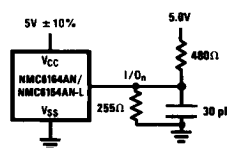

(Including Jig & Probe Capacitance)

TL/D/8808-3

Timing Waveforms

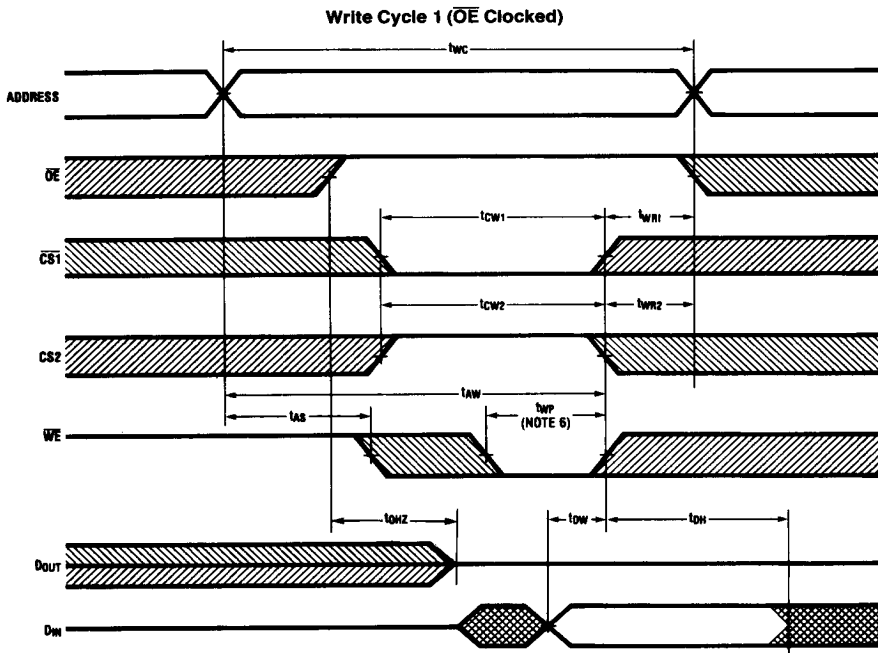

TL/D/8808-4

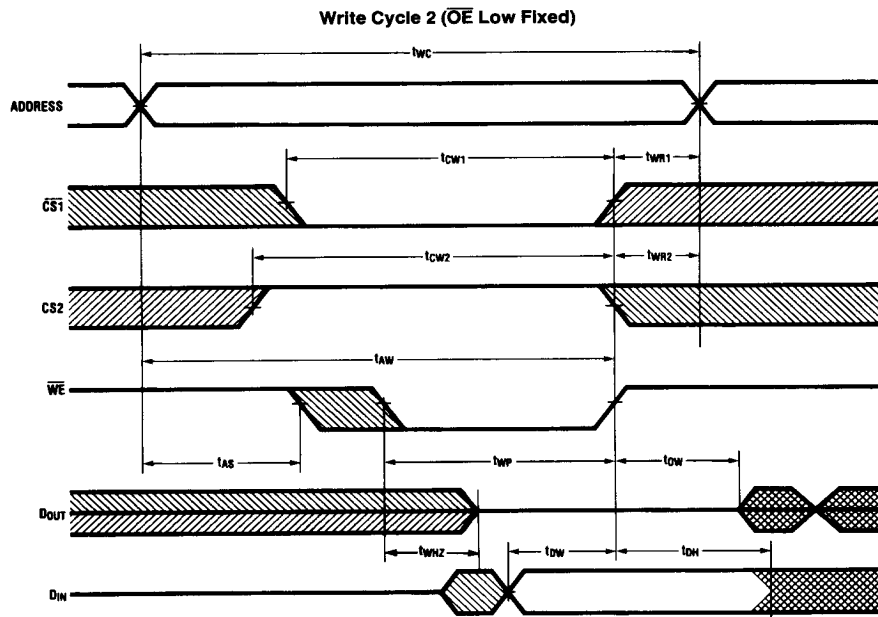

TL/D/8808-5

Timing Waveforms (Continued)

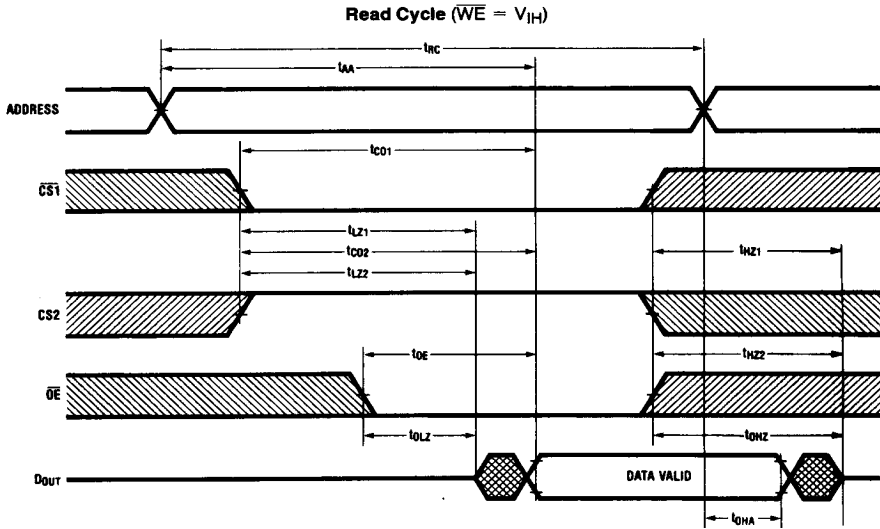

TL/D/8808-6

Low V_{CC} Data Retention (L Version)

Symbol	Parameter	Conditions	Min	Max	Units
V_{DR1}	V_{CC} for Data Retention	$\overline{CS1} > V_{IH}$, CMOS (Note 11) $\overline{CS2} > V_{IH}$, CMOS	2.0	5.5	V
V_{DR2}	V_{CC} for Data Retention	$\overline{CS2} < V_{IL}$, CMOS (Note 11)	2.0	5.5	V
I_{CCDR1}	Data Retention Current	$V_{CC} = 2V$ $\overline{CS1} > V_{IH}$, CMOS $\overline{CS2} > V_{IH}$, CMOS		40	μA
I_{CCDR2}	Data Retention Current	$V_{CC} = 2V$ $\overline{CS2} < V_{IL}$, CMOS		40	μA
t_{CDR}	Chip Deselect to Data Retention Time	See Retention Waveform	0		ns
t_R	Operation Recovery Time	See Retention Waveform	t_{RC}		ns

Low V_{CC} Data Retention Waveforms

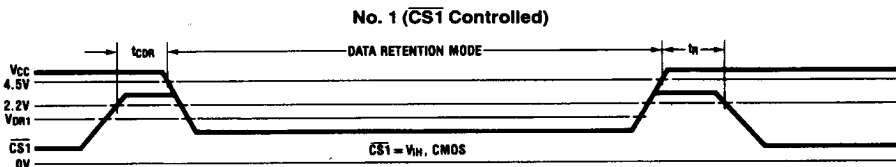

TL/D/8808-7

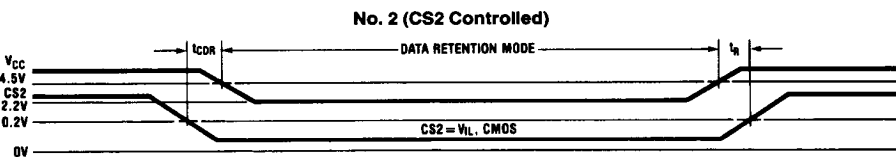

TL/D/8808-8

