



STL65N3LLH5

N-channel 30 V, 0.0048 Ω , 19 A - PowerFLAT™ (6x5)
STripFET™ V Power MOSFET

Features

Type	V _{DSS}	R _{DS(on) max}	I _D
STL65N3LLH5	30 V	<0.0058 Ω	19 A ⁽¹⁾

1. The value is rated according R_{thj-pcb}

- R_{DS(on)} * Q_g industry benchmark
- Extremely low on-resistance R_{DS(on)}
- Very low switching gate charge
- High avalanche ruggedness
- Low gate drive power losses

Application

- Switching applications

Description

This product utilizes the 5th generation of design rules of ST's proprietary STripFET™ technology. The lowest available R_{DS(on)}*Q_g, in this chip scale package, makes this device suitable for the most demanding DC-DC converter applications, where high power density is to be achieved.

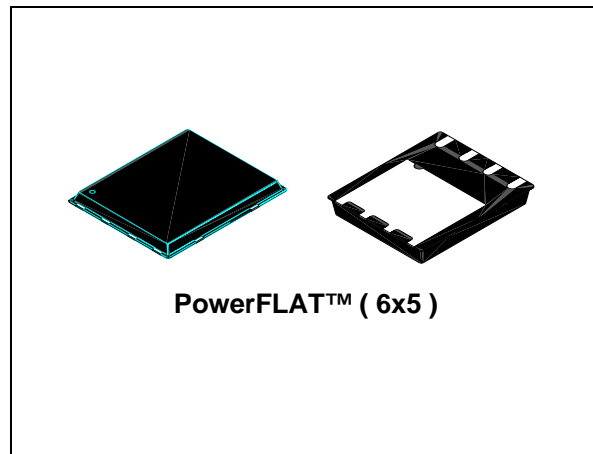

Figure 1. Internal schematic diagram

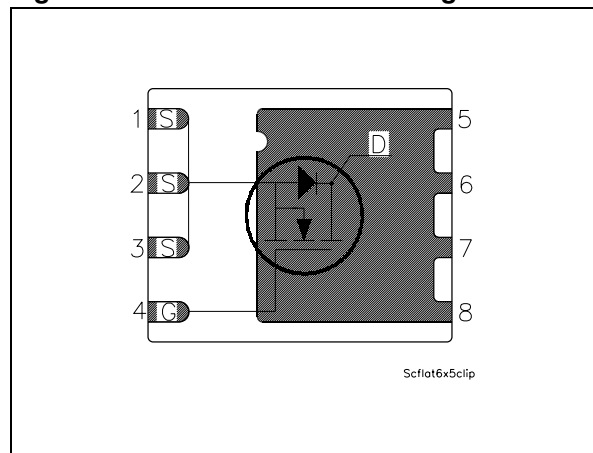

Table 1. Device summary

Order code	Marking	Package	Packaging
STL65N3LLH5	65N3LLH5	PowerFLAT™ (6x5)	Tape and reel

Contents

1	Electrical ratings	3
2	Electrical characteristics	4
	2.1 Electrical characteristics (curves)	6
3	Test circuits	8
4	Package mechanical data	9
5	Revision history	11

www.DataSheet4U.com



1 Electrical ratings

Table 2. Absolute maximum ratings

Symbol	Parameter	Value	Unit
V_{DS}	Drain-source voltage ($V_{GS} = 0$)	30	V
V_{GS}	Gate-source voltage	± 22	V
$I_D^{(1)}$	Drain current (continuous) at $T_C = 25^\circ\text{C}$	65	A
$I_D^{(1)}$	Drain current (continuous) at $T_C = 100^\circ\text{C}$	41	A
$I_D^{(2)}$	Drain current (continuous) at $T_C = 25^\circ\text{C}$	19	A
$I_D^{(2)}$	Drain current (continuous) at $T_C = 100^\circ\text{C}$	11.8	A
$I_{DM}^{(3)}$	Drain current (pulsed)	76	A
$P_{TOT}^{(1)}$	Total dissipation at $T_C = 25^\circ\text{C}$	60	W
$P_{TOT}^{(2)}$	Total dissipation at $T_C = 25^\circ\text{C}$	4	W
	Derating factor	0.03	W/ $^\circ\text{C}$
T_J	Operating junction temperature	-55 to 150	$^\circ\text{C}$
T_{stg}	Storage temperature		

1. The value is rated according R_{thj-c}
2. The value is rated according $R_{thj-pcb}$
3. Pulse width limited by safe operating area

Table 3. Thermal resistance

Symbol	Parameter	Value	Unit
$R_{thj-case}$	Thermal resistance junction-case (Drain) (steady state)	2.08	$^\circ\text{C}/\text{W}$
$R_{thj-pcb}^{(1)}$	Thermal resistance junction-ambient	31.3	$^\circ\text{C}/\text{W}$

1. When mounted on FR-4 board of 1inch², 2oz Cu, $t < 10$ sec

Table 4. Avalanche data

Symbol	Parameter	Value	Unit
I_{AV}	Not-repetitive avalanche current, (pulse width limited by T_J Max)	8.5	A
E_{AS}	Single pulse avalanche energy (starting $T_J = 25^\circ\text{C}$, $I_D = I_{AV}$, $V_{DD} = 24$ V)	180	mJ

2 Electrical characteristics

($T_{CASE}=25^{\circ}C$ unless otherwise specified)

Table 5. On/off states

Symbol	Parameter	Test conditions	Min.	Typ.	Max.	Unit
$V_{(BR)DSS}$	Drain-source breakdown voltage	$I_D = 250 \mu A, V_{GS} = 0$	30			V
I_{DSS}	Zero gate voltage drain current ($V_{GS} = 0$)	$V_{DS} = \text{Max rating},$ $V_{DS} = \text{Max rating @ } 125^{\circ}C$			1 10	μA μA
I_{GSS}	Gate body leakage current ($V_{DS} = 0$)	$V_{GS} = \pm 22 V$			± 100	nA
$V_{GS(th)}$	Gate threshold voltage	$V_{DS} = V_{GS}, I_D = 250 \mu A$	1			V
$R_{DS(on)}$	Static drain-source on resistance	$V_{GS} = 10 V, I_D = 9.5 A$ $V_{GS} = 4.5 V, I_D = 9.5 A$		0.0048 0.006	0.0058 0.0075	Ω Ω

Table 6. Dynamic

Symbol	Parameter	Test conditions	Min.	Typ.	Max.	Unit
C_{iss}	Input capacitance			1500		pF
C_{oss}	Output capacitance	$V_{DS} = 25 V, f = 1 \text{ MHz},$ $V_{GS} = 0$		295		pF
C_{rss}	Reverse transfer capacitance			39		pF
Q_g	Total gate charge	$V_{DD} = 15 V, I_D = 19 A$		12		nC
Q_{gs}	Gate-source charge	$V_{GS} = 4.5 V$		4		nC
Q_{gd}	Gate-drain charge	(see Figure 14)		4.7		nC

Table 7. Switching times

Symbol	Parameter	Test conditions	Min.	Typ.	Max.	Unit
$t_{d(on)}$	Turn-on delay time	$V_{DD}=15\text{ V}$, $I_D=9.5\text{ A}$, $R_G=4.7\ \Omega$, $V_{GS}=10\text{ V}$ <i>(see Figure 13)</i>		9.3		ns
t_r	Rise time			14.5		ns
$t_{d(off)}$	Turn-off delay time			22.7		ns
t_f	Fall time			4.5		ns

Table 8. Source drain diode

Symbol	Parameter	Test conditions	Min	Typ.	Max	Unit
I_{SD}	Source-drain current				19	A
$I_{SDM}^{(1)}$	Source-drain current (pulsed)				76	A
$V_{SD}^{(2)}$	Forward on voltage	$I_{SD} = 19\text{ A}$, $V_{GS}=0$			1.1	V
t_{rr}	Reverse recovery time	$I_{SD} = 19\text{ A}$, $di/dt = 100\text{ A}/\mu\text{s}$, $V_{DD}=25\text{ V}$, $T_j=150\text{ }^\circ\text{C}$		25		ns
Q_{rr}	Reverse recovery charge			17.5		nC
I_{RRM}	Reverse recovery current			1.4		A

1. Pulse width limited by safe operating area
2. Pulsed: pulse duration=300 μs , duty cycle 1.5%

2.1 Electrical characteristics (curves)

Figure 2. Safe operating area

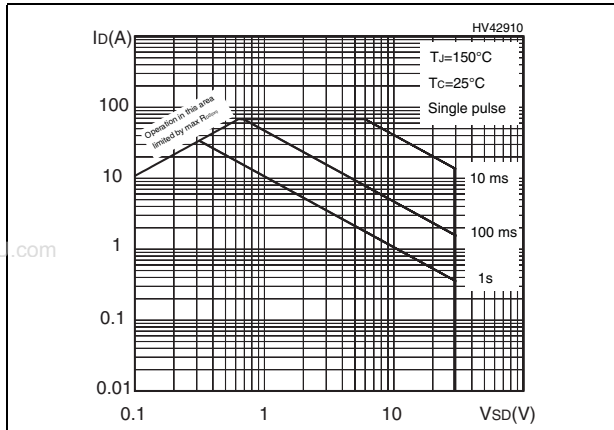

Figure 3. Thermal impedance

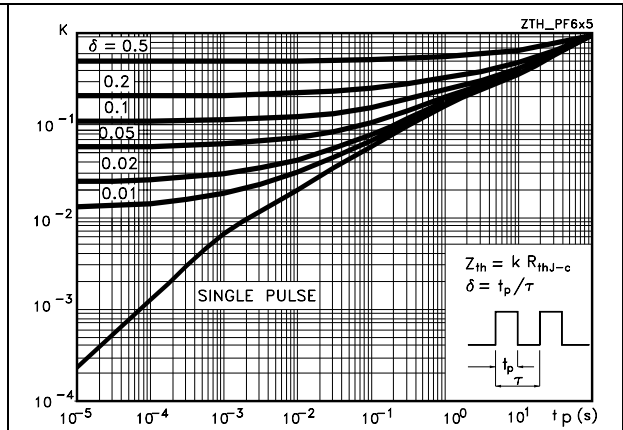

Figure 4. Output characteristics

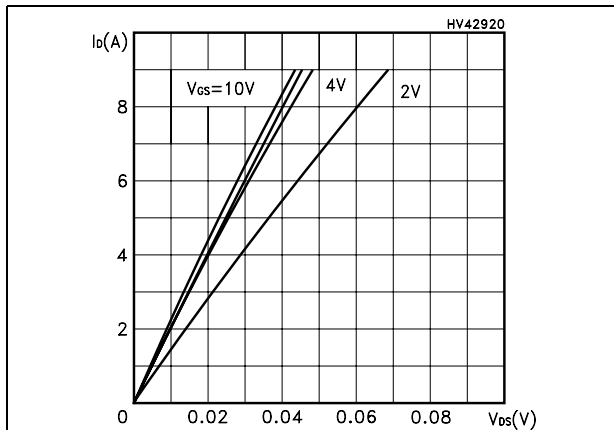

Figure 5. Transfer characteristics

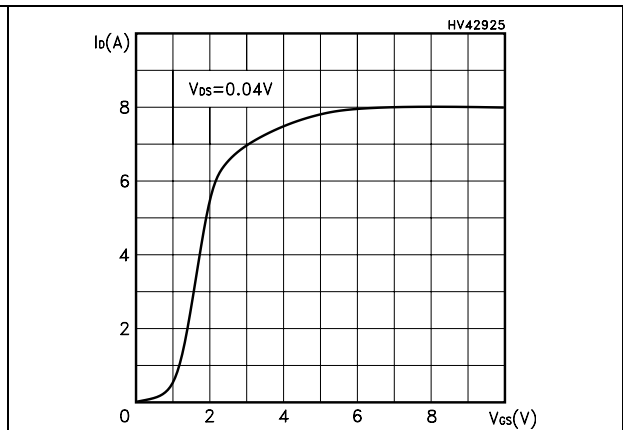

Figure 6. Normalized $B_{V_{DS}}$ vs temperature

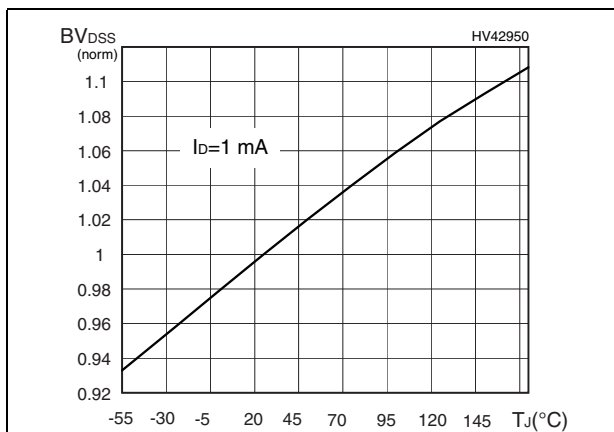

Figure 7. Static drain-source on resistance

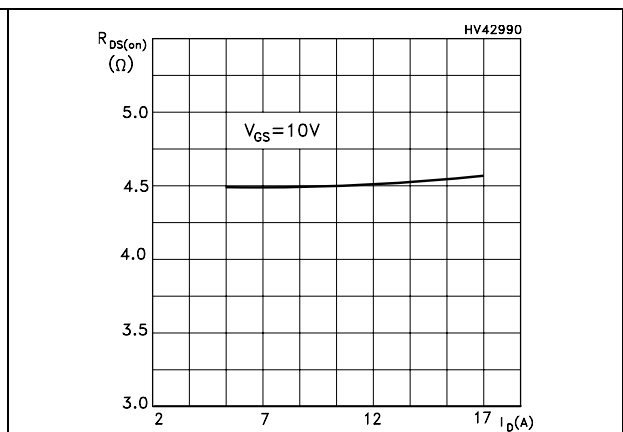

Figure 8. Gate charge vs gate-source voltage Figure 9. Capacitance variations

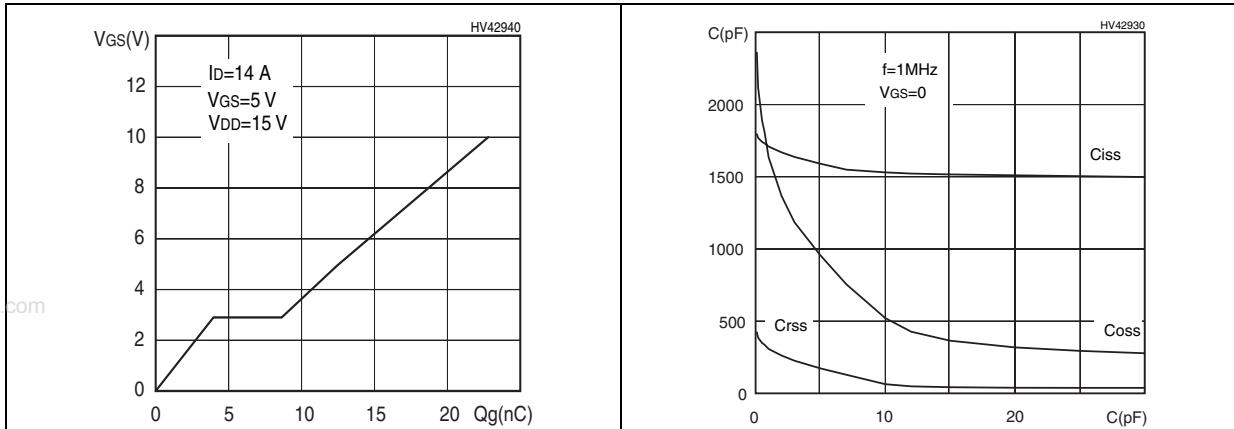

Figure 10. Normalized gate threshold voltage vs temperature Figure 11. Normalized on resistance vs temperature

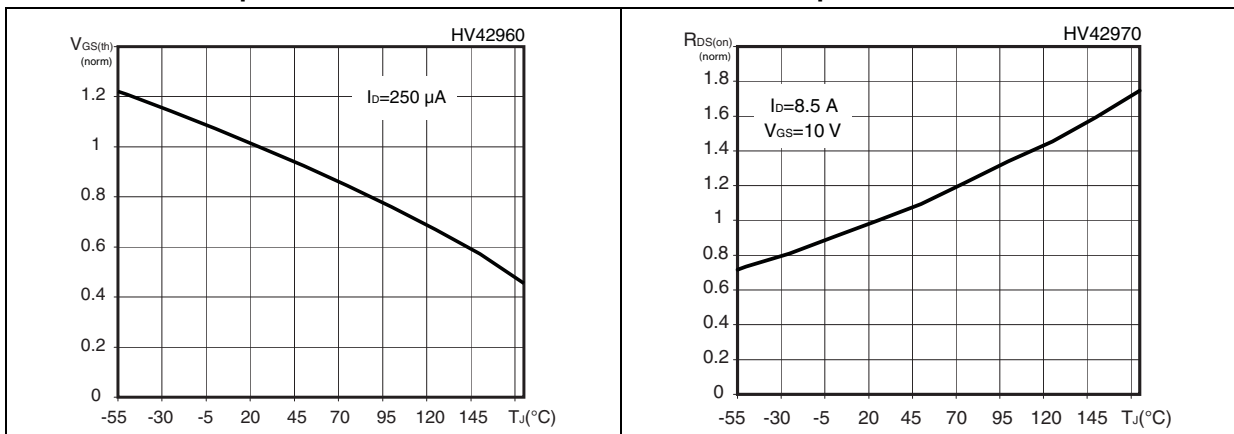
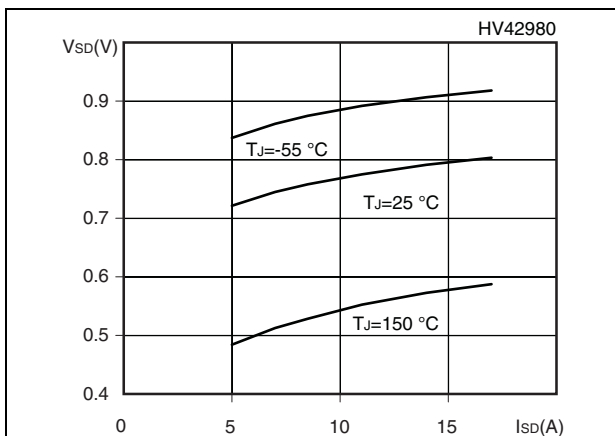

Figure 12. Source-drain diode forward characteristics



3 Test circuits

Figure 13. Switching times test circuit for resistive load

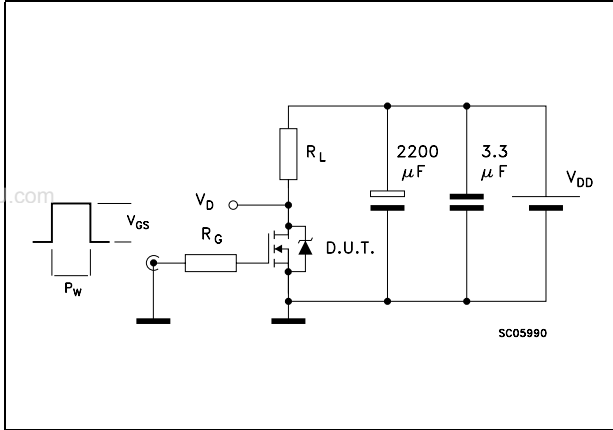

Figure 14. Gate charge test circuit

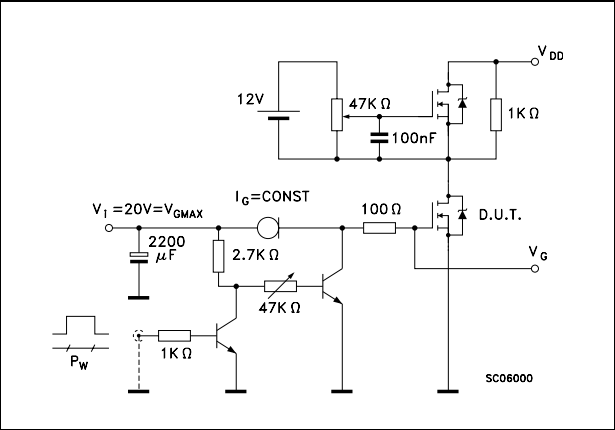

Figure 15. Test circuit for inductive load switching and diode recovery times

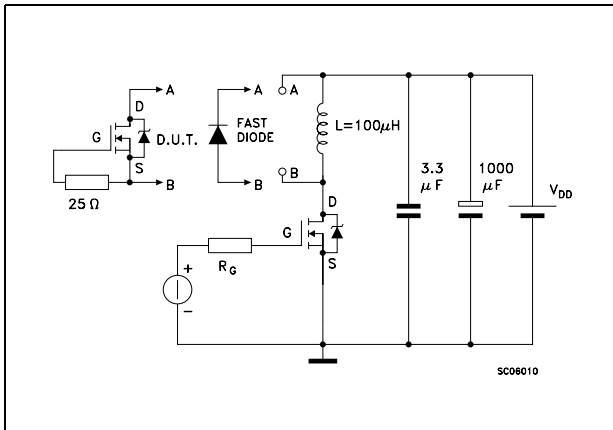

Figure 16. Unclamped inductive load test circuit

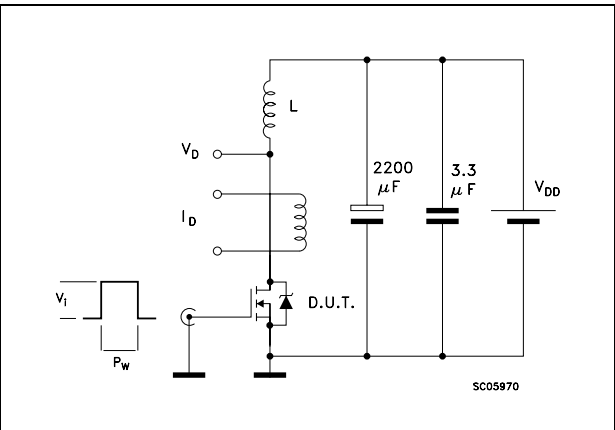
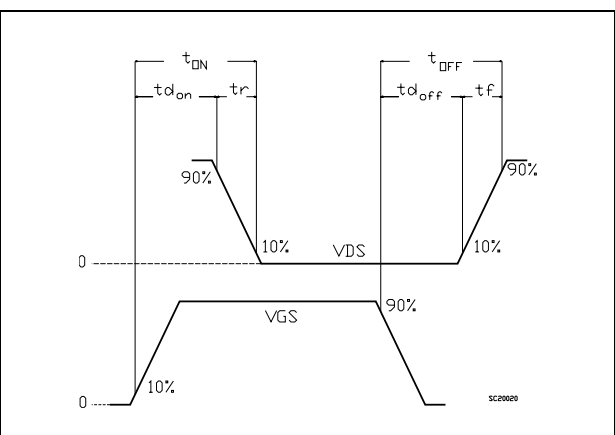

Figure 17. Unclamped inductive waveform



Figure 18. Switching time waveform



4 Package mechanical data

In order to meet environmental requirements, ST offers these devices in ECOPACK® packages. These packages have a Lead-free second level interconnect . The category of second level interconnect is marked on the package and on the inner box label, in compliance with JEDEC Standard JESD97. The maximum ratings related to soldering conditions are also marked on the inner box label. ECOPACK is an ST trademark. ECOPACK specifications are available at: www.st.com

PowerFLAT™ (6x5) mechanical data

DM .	mm .			inch		
	Min.	Typ.	Max.	Min.	Typ.	Max.
A	0.80	0.83	0.93	0.031	0.32	0.036
A1		0.02	0.05		0.0007	0.0019
A3		0.20			0.007	
b	0.35	0.40	0.47	0.013	0.015	0.018
D		5.00			0.196	
D1		4.75			0.187	
D2	4.15	4.20	4.25	0.163	0.165	0.167
E		6.00			0.236	
E1		5.75			0.226	
E2	3.43	3.48	3.53	0.135	0.137	0.139
E4	2.58	2.63	2.68		0.103	0.105
e		1.27			0.050	
L	0.70	0.80	0.90	0.027	0.031	0.035

www.DataSheet4U.com

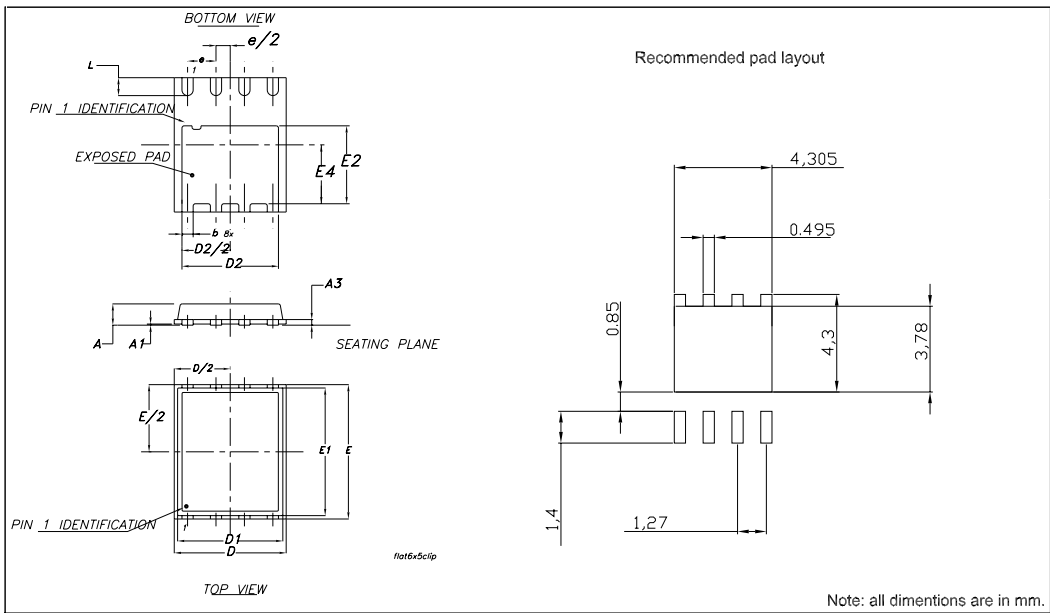

5 Revision history

Table 9. Document revision history

Date	Revision	Changes
04-Jan-2007	1	First release
01-Apr-2008	2	Document status promoted from preliminary data to datasheet.
07-May-2008	3	Updated Figure 9: Capacitance variations
23-Sep-2008	4	V_{GS} value has been changed on Table 2 and Table 5

www.DataSheet4U.com

Please Read Carefully:

Information in this document is provided solely in connection with ST products. STMicroelectronics NV and its subsidiaries ("ST") reserve the right to make changes, corrections, modifications or improvements, to this document, and the products and services described herein at any time, without notice.

All ST products are sold pursuant to ST's terms and conditions of sale.

Purchasers are solely responsible for the choice, selection and use of the ST products and services described herein, and ST assumes no liability whatsoever relating to the choice, selection or use of the ST products and services described herein.

No license, express or implied, by estoppel or otherwise, to any intellectual property rights is granted under this document. If any part of this document refers to any third party products or services it shall not be deemed a license grant by ST for the use of such third party products or services, or any intellectual property contained therein or considered as a warranty covering the use in any manner whatsoever of such third party products or services or any intellectual property contained therein.

UNLESS OTHERWISE SET FORTH IN ST'S TERMS AND CONDITIONS OF SALE ST DISCLAIMS ANY EXPRESS OR IMPLIED WARRANTY WITH RESPECT TO THE USE AND/OR SALE OF ST PRODUCTS INCLUDING WITHOUT LIMITATION IMPLIED WARRANTIES OF MERCHANTABILITY, FITNESS FOR A PARTICULAR PURPOSE (AND THEIR EQUIVALENTS UNDER THE LAWS OF ANY JURISDICTION), OR INFRINGEMENT OF ANY PATENT, COPYRIGHT OR OTHER INTELLECTUAL PROPERTY RIGHT.

UNLESS EXPRESSLY APPROVED IN WRITING BY AN AUTHORIZED ST REPRESENTATIVE, ST PRODUCTS ARE NOT RECOMMENDED, AUTHORIZED OR WARRANTED FOR USE IN MILITARY, AIR CRAFT, SPACE, LIFE SAVING, OR LIFE SUSTAINING APPLICATIONS, NOR IN PRODUCTS OR SYSTEMS WHERE FAILURE OR MALFUNCTION MAY RESULT IN PERSONAL INJURY, DEATH, OR SEVERE PROPERTY OR ENVIRONMENTAL DAMAGE. ST PRODUCTS WHICH ARE NOT SPECIFIED AS "AUTOMOTIVE GRADE" MAY ONLY BE USED IN AUTOMOTIVE APPLICATIONS AT USER'S OWN RISK.

Resale of ST products with provisions different from the statements and/or technical features set forth in this document shall immediately void any warranty granted by ST for the ST product or service described herein and shall not create or extend in any manner whatsoever, any liability of ST.

ST and the ST logo are trademarks or registered trademarks of ST in various countries.

Information in this document supersedes and replaces all information previously supplied.

The ST logo is a registered trademark of STMicroelectronics. All other names are the property of their respective owners.

© 2008 STMicroelectronics - All rights reserved

STMicroelectronics group of companies

Australia - Belgium - Brazil - Canada - China - Czech Republic - Finland - France - Germany - Hong Kong - India - Israel - Italy - Japan - Malaysia - Malta - Morocco - Singapore - Spain - Sweden - Switzerland - United Kingdom - United States of America

www.st.com