

Features

- Diffused Junction
- Low Forward Voltage Drop
- High Current Capability
- High Reliability
- High Surge Current Capability

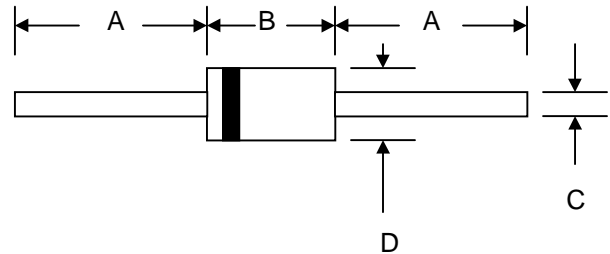

Mechanical Data

- Case: R-1, Molded Plastic
- Terminals: Plated Leads Solderable per MIL-STD-202, Method 208
- Polarity: Cathode Band
- Weight: 0.181 grams (approx.)
- Mounting Position: Any
- Marking: Type Number
- **Lead Free: For RoHS / Lead Free Version, Add “-LF” Suffix to Part Number, See Page 4**

R-1		
Dim	Min	Max
A	20.0	—
B	2.90	3.50
C	0.53	0.64
D	2.20	2.60
All Dimensions in mm		

Maximum Ratings and Electrical Characteristics @ $T_A=25^\circ\text{C}$ unless otherwise specified

Single Phase, half wave, 60Hz, resistive or inductive load.
For capacitive load, derate current by 20%.

Characteristic	Symbol	1A1	1A2	1A3	1A4	1A5	1A6	1A7	Unit
Peak Repetitive Reverse Voltage	V_{RRM}								
Working Peak Reverse Voltage	V_{RWM}	50	100	200	400	600	800	1000	V
DC Blocking Voltage	V_R								
RMS Reverse Voltage	$V_{R(RMS)}$	35	70	140	280	420	560	700	V
Average Rectified Output Current (Note 1) @ $T_A = 75^\circ\text{C}$	I_O	1.0							A
Non-Repetitive Peak Forward Surge Current 8.3ms Single half sine-wave superimposed on rated load (JEDEC Method)	I_{FSM}	30							A
Forward Voltage @ $I_F = 1.0\text{A}$	V_{FM}	1.0							V
Peak Reverse Current @ $T_A = 25^\circ\text{C}$ At Rated DC Blocking Voltage @ $T_A = 100^\circ\text{C}$	I_{RM}	5.0 50							μA
Typical Junction Capacitance (Note 2)	C_j	15							pF
Typical Thermal Resistance Junction to Ambient (Note 1)	$R_{\theta JA}$	50							$^\circ\text{C/W}$
Operating Temperature Range	T_j	-65 to +125							$^\circ\text{C}$
Storage Temperature Range	T_{STG}	-65 to +150							$^\circ\text{C}$

Note: 1. Leads maintained at ambient temperature at a distance of 9.5mm from the case.
2. Measured at 1.0 MHz and Applied Reverse Voltage of 4.0V D.C.

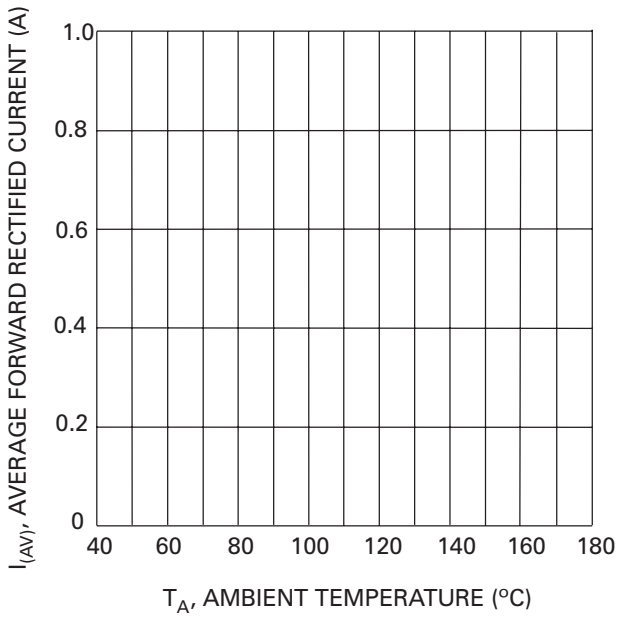

Fig. 1 Forward Current Derating Curve

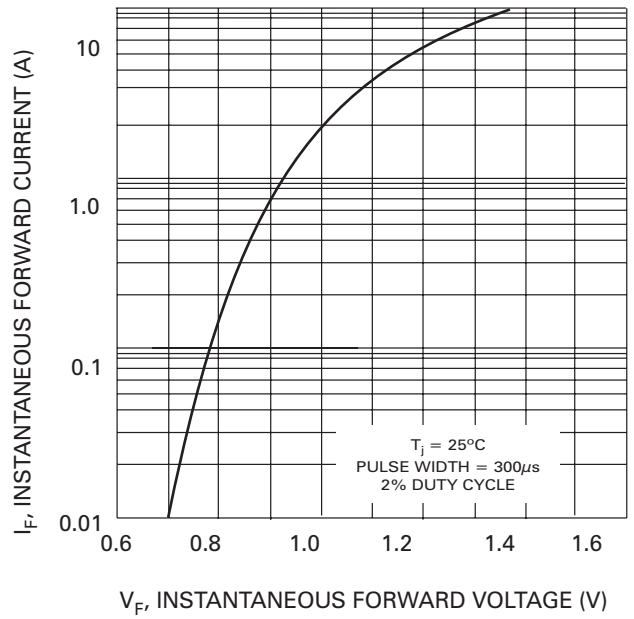

Fig. 2 Typical Forward Characteristics

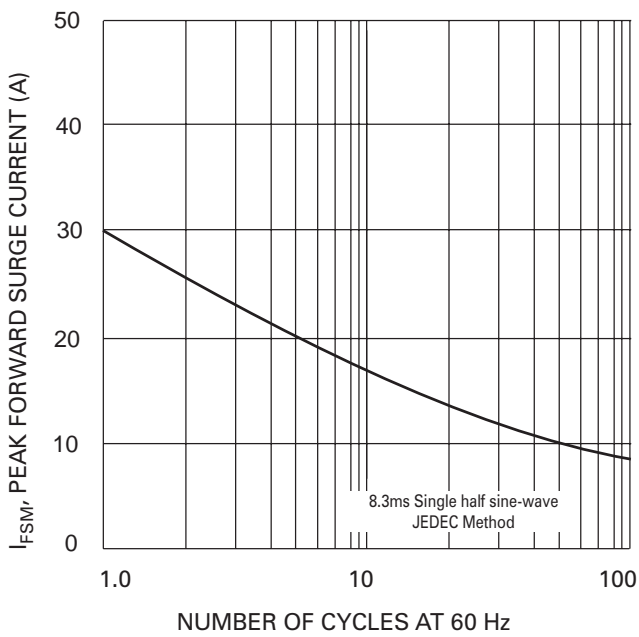

Fig. 3 Max Non-Repetitive Peak Fwd Surge Current

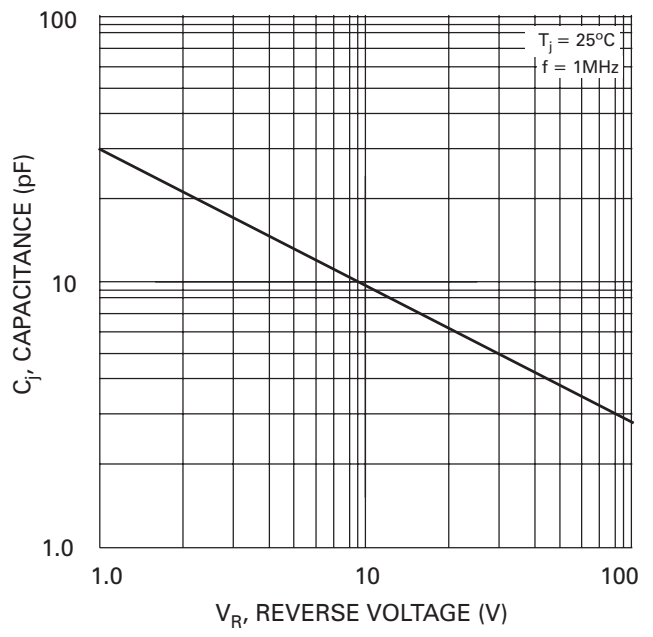
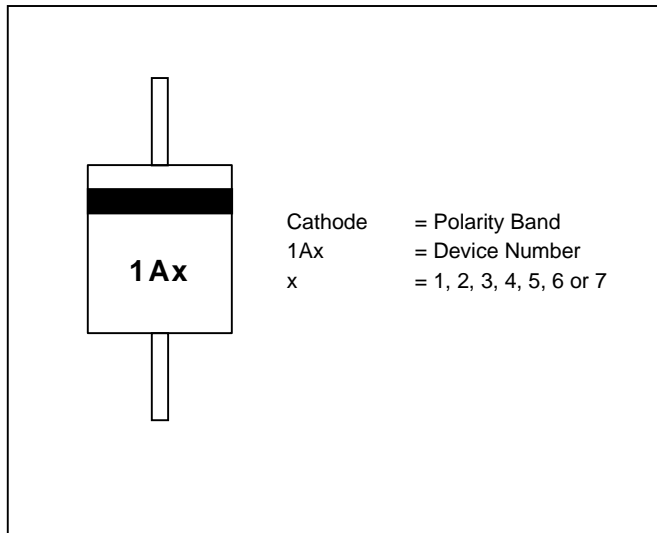
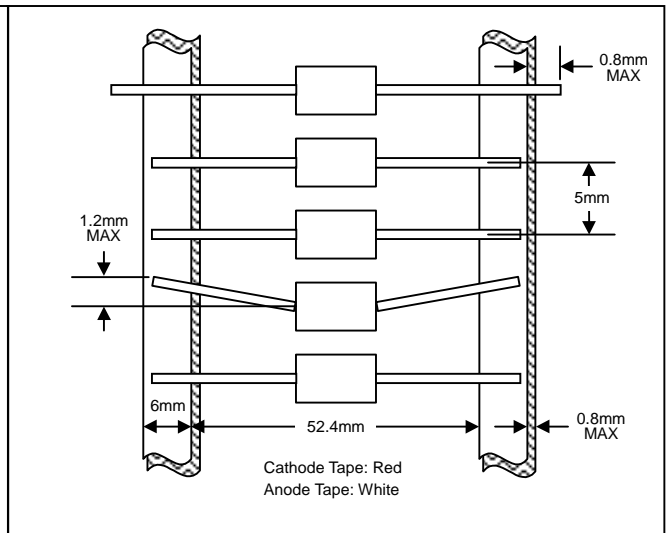

Fig. 4 Typical Junction Capacitance

MARKING INFORMATION



TAPING SPECIFICATIONS



PACKAGING INFORMATION

TAPE & REEL

330mm
 Product ID Label
 80±5mm

TAPE & BOX

150mm
 255mm
 75mm
 Product ID Label
 Inspection Hole (both ends)

BULK

20mm
 198mm
 84mm

Packaging	Reel Diameter / Box Size (mm)	Quantity (PCS)	Carton Size (mm)	Quantity (PCS)	Approx. Gross Weight (KG)
TAPE & REEL	330	5,000	370 x 370 x 420	25,000	9.0
TAPE & BOX	255 x 75 x 150	5,000	400 x 273 x 415	50,000	20.0
BULK	198 x 84 x 20	1,000	459 x 214 x 256	50,000	18.5

Note: 1. Paper reel, white or gray color. Core material: plastic or metal.
 2. Components are packed in accordance with EIA standard RS-296-E.

ORDERING INFORMATION

Product No.	Package Type	Shipping Quantity
1A1-T3	R-1	5000/Tape & Reel
1A1-TB	R-1	5000/Tape & Box
1A1	R-1	1000 Units/Box
1A2-T3	R-1	5000/Tape & Reel
1A2-TB	R-1	5000/Tape & Box
1A2	R-1	1000 Units/Box
1A3-T3	R-1	5000/Tape & Reel
1A3-TB	R-1	5000/Tape & Box
1A3	R-1	1000 Units/Box
1A4-T3	R-1	5000/Tape & Reel
1A4-TB	R-1	5000/Tape & Box
1A4	R-1	1000 Units/Box
1A5-T3	R-1	5000/Tape & Reel
1A5-TB	R-1	5000/Tape & Box
1A5	R-1	1000 Units/Box
1A6-T3	R-1	5000/Tape & Reel
1A6-TB	R-1	5000/Tape & Box
1A6	R-1	1000 Units/Box
1A7-T3	R-1	5000/Tape & Reel
1A7-TB	R-1	5000/Tape & Box
1A7	R-1	1000 Units/Box

1. Products listed in **bold** are WTE **Preferred** devices.
2. Shipping quantity given is for minimum packing quantity only. For minimum order quantity, please consult the Sales Department.
3. **To order RoHS / Lead Free version (with Lead Free finish), add "-LF" suffix to part number above. For example, 1A1-TB-LF.**

Won-Top Electronics Co., Ltd (WTE) has checked all information carefully and believes it to be correct and accurate. However, WTE cannot assume any responsibility for inaccuracies. Furthermore, this information does not give the purchaser of semiconductor devices any license under patent rights to manufacturer. WTE reserves the right to change any or all information herein without further notice.

WARNING: DO NOT USE IN LIFE SUPPORT EQUIPMENT. WTE power semiconductor products are not authorized for use as critical components in life support devices or systems without the express written approval.

Won-Top Electronics Co., Ltd.

No. 44 Yu Kang North 3rd Road, Chine Chen Dist., Kaohsiung, Taiwan

Phone: 886-7-822-5408 or 886-7-822-5410

Fax: 886-7-822-5417

Email: sales@wontop.com

Internet: http://www.wontop.com

We power your everyday.