

GESD1060

NPN EPITAXIAL PLANAR TRANSISTOR

Description

The GESD1060 is designed for relay drivers, high-speed inverters, converters and other general large-current switching.

Features

- Low Collector-Emitter Saturation Voltage : $V_{CE(sat)} = 0.4V$ (Max.) @ $I_C = 3A, I_B = 0.3A$,

Package Dimensions

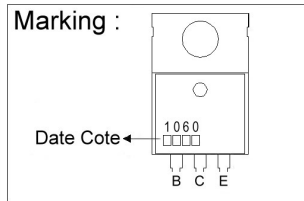
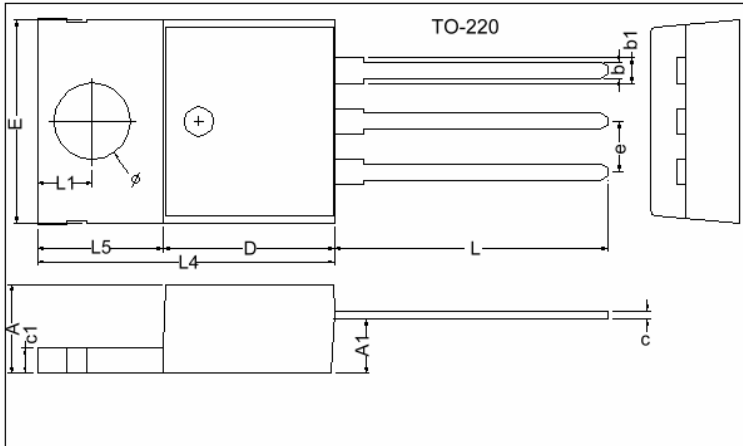

REF.	Millimeter		REF.	Millimeter	
	Min.	Max.		Min.	Max.
A	4.40	4.80	c1	1.25	1.45
b	0.76	1.00	b1	1.17	1.47
c	0.36	0.50	L	13.25	14.25
D	8.60	9.00	e	2.54 REF.	
E	9.80	10.4	L1	2.60	2.89
L4	14.7	15.3	Ø	3.71	3.96
L5	6.20	6.60	A1	2.60	2.80

Absolute Maximum Ratings (TA=25°C)

Parameter	Symbol	Ratings	Unit
Collector to Base Voltage	V_{CB0}	60	V
Collector to Emitter Voltage	V_{CE0}	50	V
Emitter to Base Voltage	V_{EB0}	6	V
Collector Current	I_C	5	A
Collector Current (Pulse)	I_{CP}	9	A
Total Device Dissipation (TC=25°C)	P_D	30	W
Junction Temperature	T_J	150	°C
Storage Temperature	T_{stg}	-55 ~ +150	°C

Electrical Characteristics (TA = 25°C unless otherwise noted)

Symbol	Min.	Typ.	Max.	Unit	Test Conditions
BV_{CB0}	60	-	-	V	$I_C = 1mA, I_E = 0$
BV_{CE0}	50	-	-	V	$I_C = 1mA, I_B = 0$
BV_{EB0}	6	-	-	V	$I_E = 1mA, I_C = 0$
I_{CB0}	-	-	100	uA	$V_{CB} = 40V, I_E = 0$
I_{EB0}	-	-	100	uA	$V_{EB} = 4V, I_C = 0$
* $V_{CE(sat)}$	-	-	0.4	V	$I_C = 3A, I_B = 0.3A$
* h_{FE1}	70	-	280		$V_{CE} = 2V, I_C = 1A$
* h_{FE2}	30	-	-		$V_{CE} = 2V, I_C = 3A$
f_T	-	30	-	MHz	$V_{CE} = 5V, I_C = 1A$
C_{ob}	-	100	-	pF	$V_{CB} = 10V, I_E = 0, f = 1MHz$
t_{on} (Turn-on Time)	-	0.1	-	uS	See specified test circuit
t_{stg} (Storage Time)	-	1.4	-		
t_f (Fall Time)	-	0.2	-		

*Pulse Test: Pulse Width $\leq 380\mu s$, Duty Cycle $\leq 2\%$

Classification Of hFE1

Rank	Q	R	S
Range	70 - 140	100 - 200	140 - 280

Switching Time Test Circuit

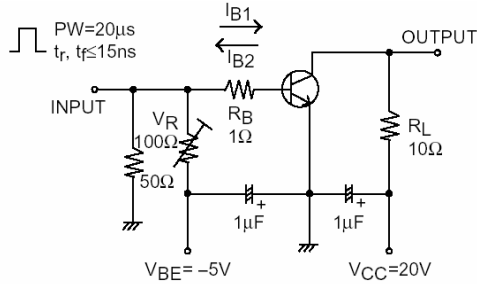

$$I_C = 10I_{B1} = -10I_{B2} = 2A$$

Characteristics Curve

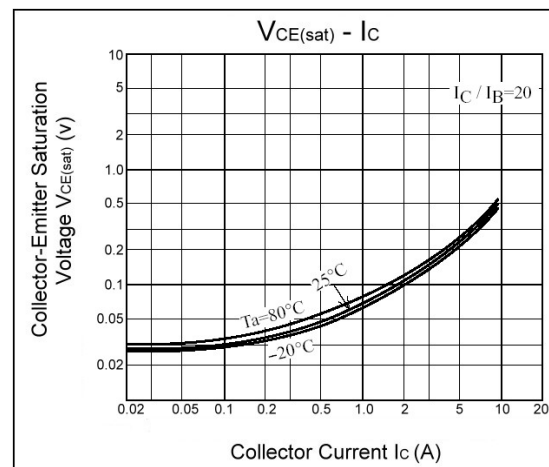
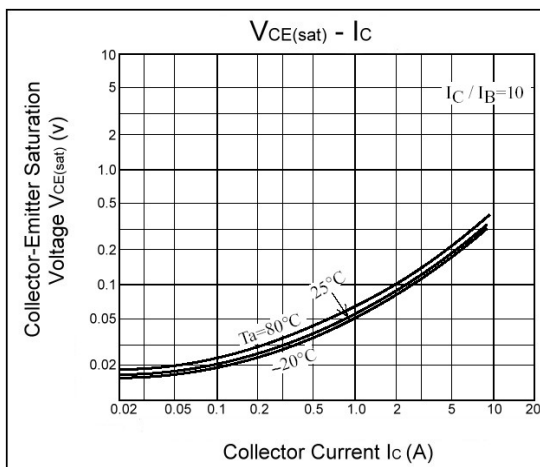
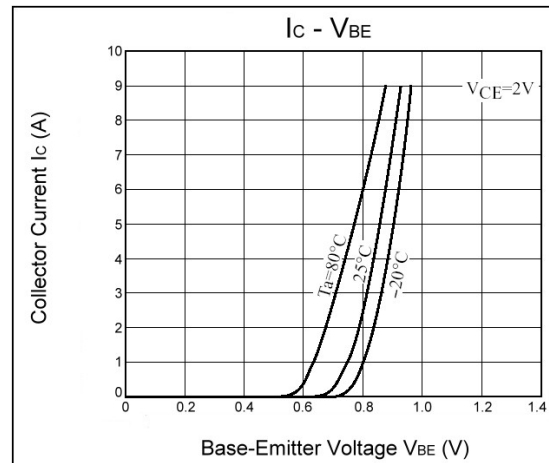
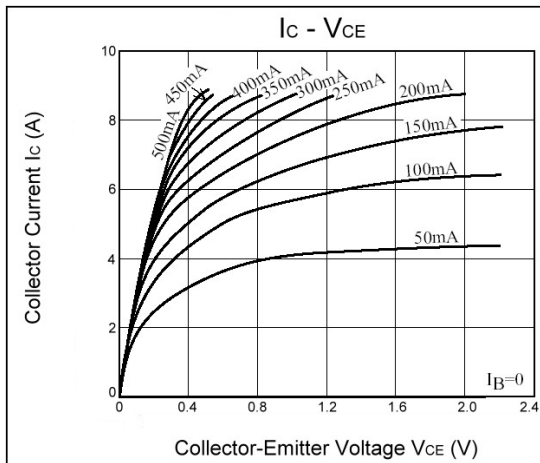

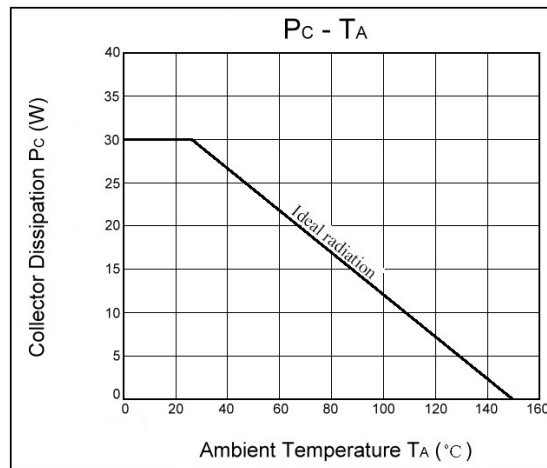
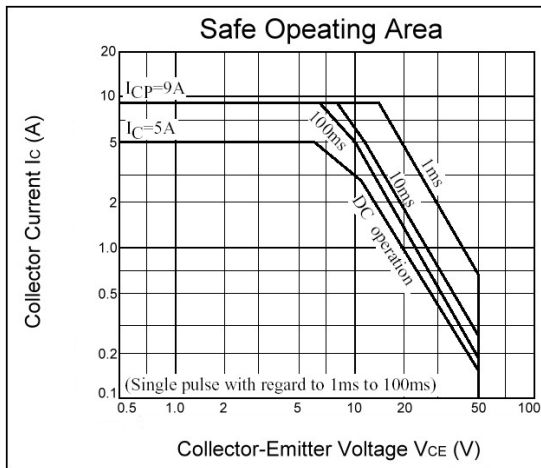
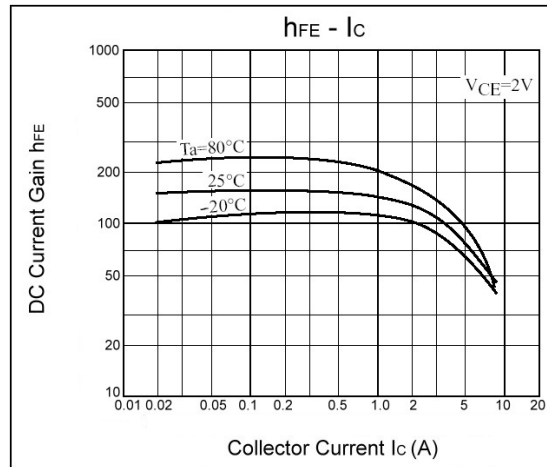
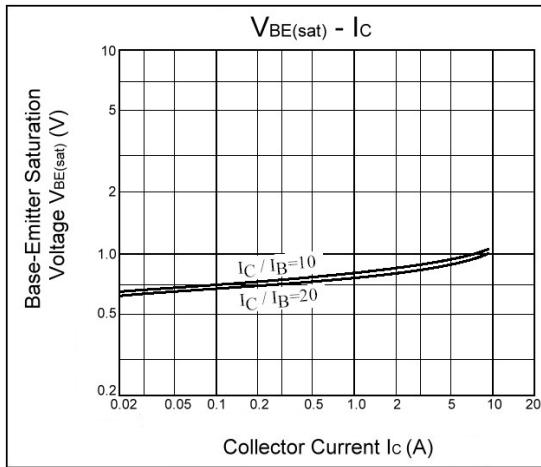

Important Notice:

- All rights are reserved. Reproduction in whole or in part is prohibited without the prior written approval of GTM.
- GTM reserves the right to make changes to its products without notice.
- GTM semiconductor products are not warranted to be suitable for use in life-support Applications, or systems.
- GTM assumes no liability for any consequence of customer product design, infringement of patents, or application assistance.

Head Office And Factory:

- **Taiwan:** No. 17-1 Tatung Rd. Fu Kou Hsin-Chu Industrial Park, Hsin-Chu, Taiwan, R. O. C.
- TEL : 886-3-597-7061 FAX : 886-3-597-9220, 597-0785
- **China:** (201203) No.255, Jang-Jiang Tsai-Lueng RD. , Pu-Dung-Hsin District, Shang-Hai City, China
- TEL : 86-21-5895-7671 ~ 4 FAX : 86-21-38950165