

FYLF- 1860UY1C

Features:

- High intensity
- General purpose leads
- RoHs compliant.

Descriptions:

- Dice material: AlGaInP
- Emitting Color: Super bright yellow
- Lens Type: Water clear

Radiation pattern.

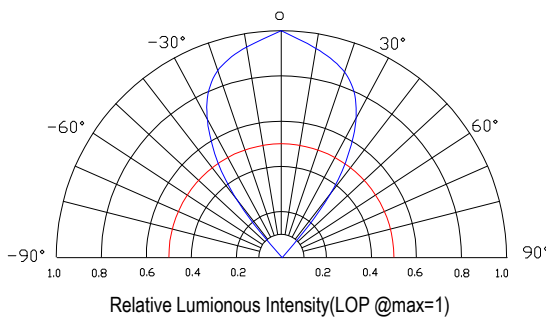

Package configuration

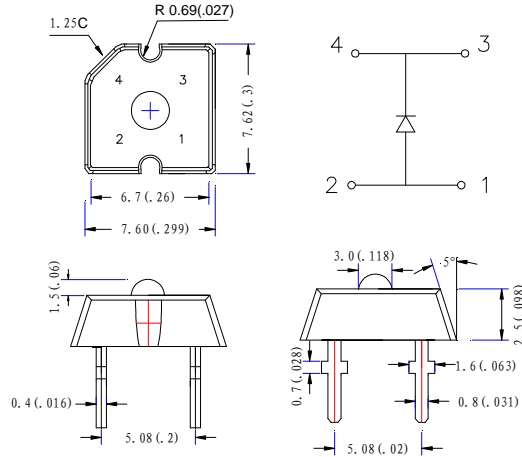

- ◆ All dimensions are millimeters (inches)
- ◆ Tolerance is $\pm 0.25\text{mm}(0.010\text{'})$ unless otherwise noted.

Absolute maximum ratings(Ta=25 °c)

Parameter	MAX.	Unit
Power Dissipation	50	mW
Peak Forward Current (1/10 Duty Cycle, 0.1ms Pulse Width)	100	mA
Continuous Forward Current	20	mA
Derating Linear From 50°C	0.4	mA/°C
Reverse Voltage	5	V
Operating Temperature Range	-30°C to +80°C	
Storage Temperature Range	-40°C to +100°C	
Lead Soldering Temperature[4mm(.157") From Body]	260°C for 5 Seconds	

Electrical and optical characteristics(Ta=25 °c)

Parameter	Symbol	Min.	Typ.	Max.	Unit	Test Condition
Luminous Intensity	I_v	-	1000	-	mcd	$I_F=20\text{mA}$
Viewing Angle	$2\theta_{1/2}$	60	70	80	Deg	
Peak Emission	λ_p	583	588	593	nm	
Dominant Wavelength	λ_d	585	590	595	nm	
Spectral Line Half-Width	$\Delta\lambda$	10	15	20	nm	
Forward Voltage	V_F	1.8	2.0	2.3	V	$V_R=5\text{V}$
Reverse Current	I_R			50	μA	

Typical Electrical Characteristics Curves

(25 °c Ambient Temperature Unless Otherwise Noted)

Spectral Reduance

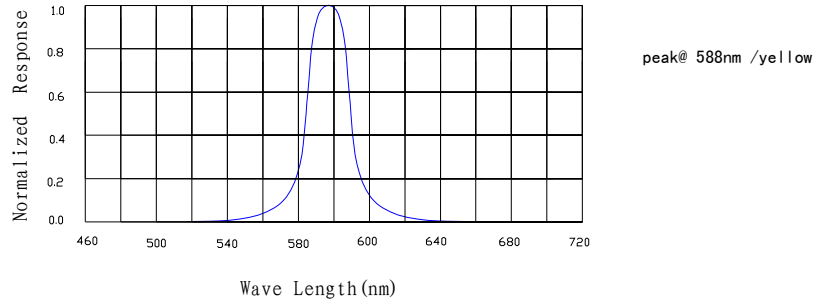

Forward Current Vs Forward Voltage

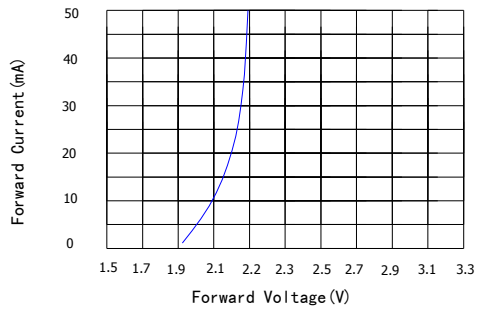

Relative Luminous intensity vs Forward current

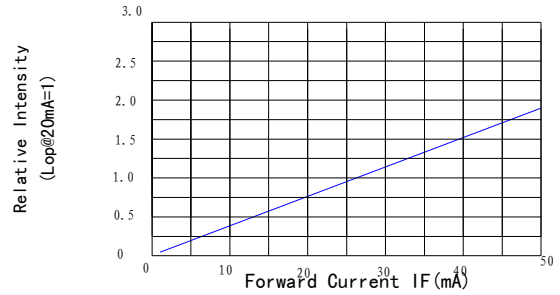

Forward Current Derating Curve

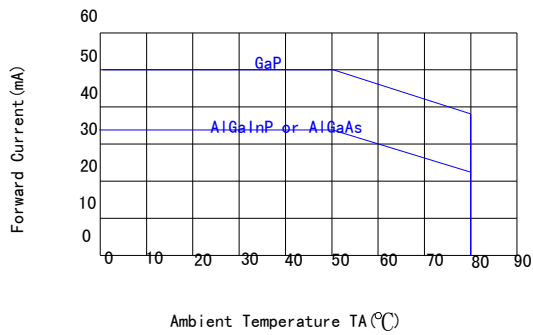

Luminous Intensity Vs. Ambient Temperature

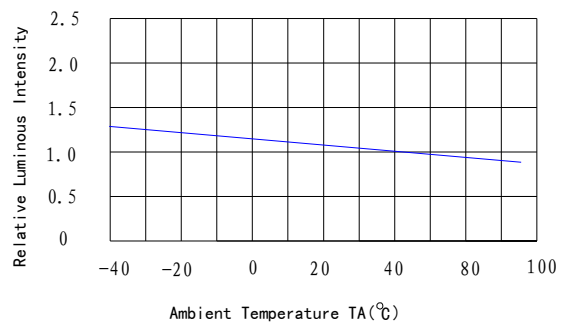

Flux LEDs PACKING.

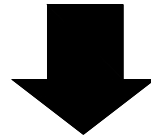
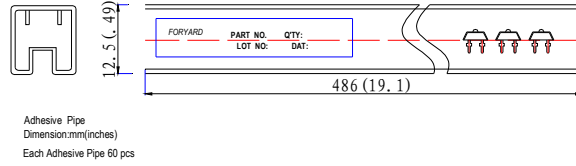
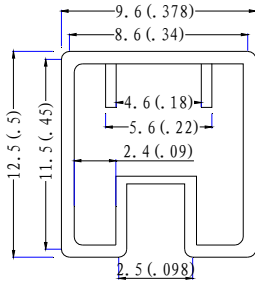

Box
Dimension (cm) : 53*15*16.5

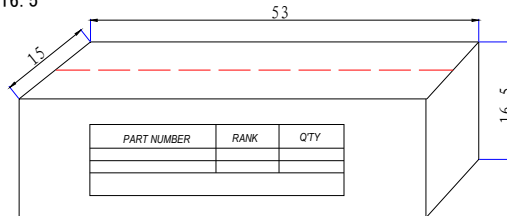

Each box/carotn 10,000pcs

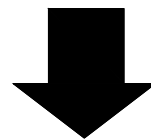

CARTON
Dimension(cm):56*32*34.4

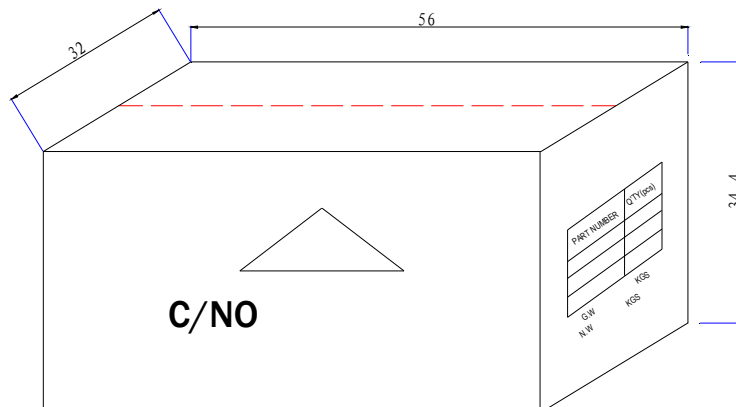

4 Boxes/Carotn
Totail :40,000pcs