



SIL12F Series

3.3 Vin to 5 Vin single output



DC-DC CONVERTERS

F Class Non-isolated

1

NEW Product

- **Designed to meet ultra fast transient requirements up to 300 A/μs step load transients**
- **12 A current rating**
- **Input voltage range: 3.0 Vdc to 5.5 Vdc**
- **Output voltage range: 0.9 Vdc to 3.3 Vdc**
- **Extremely low internal power dissipation**
- **Minimal thermal design concerns**
- **RoHS compliant**



The SIL12F series is a new range of ultra-compact non-isolated point-of-load converters for space-critical applications. The new SIL12F Typhoon™ family single-in-line converter has a footprint of just 38.1 x 8.5 mm - and unlike competitive products on the market, requires only the addition of a small number of ceramic output capacitors to realise a complete high-performance point-of-load (POL) solution. The SIL12F is primarily intended for use on very densely packed, high functionality boards and for powering advanced silicon including network and communication processors, DSPs, FPGAs and ASICs. A key advantage of the SIL12F is that it only needs the addition of five 22 μF ceramic output capacitors to provide a complete full-specification, high efficiency POL solution with transient response capabilities that extend up to 300 A/μs. The total board space required for the module and capacitors is a mere 400 mm², facilitating easy co-location with the load.

**2 YEAR WARRANTY**

All specifications are typical at nominal input, full load at 25 °C unless otherwise stated. External output capacitance required (See Note 4)

SPECIFICATIONS**OUTPUT SPECIFICATIONS**

| | | |
|--------------------------|----------------|--|
| Voltage adjustability | (Trimmable) | 0.9-3.3 Vdc |
| Setpoint accuracy | | ±1.0% typ. |
| Line regulation | | ±1.0% typ. |
| Load regulation | | ±1.0% typ. |
| Total error band | | ±3.0% typ. |
| Minimum load | | 0 A |
| Overshoot/undershoot | | None |
| Ripple and noise | 5 Hz to 20 MHz | 40 mV pk-pk 25 mV rms |
| Temperature co-efficient | | ±0.01%/°C |
| Transient response | di/dt 300 A/μs | 12 A load step 200 mV deviation 30 μs settling time to within ±1.0% |
| Remote sense | | 10% Vo compensation |

INPUT SPECIFICATIONS

| | | |
|------------------------|---------|--|
| Input voltage range | | 3-5.5 Vdc |
| Input current | No load | 120 mA |
| Input current (max.) | | 8.5 A max. @ Io max. and Vout = 3.3 V |
| Input reflected ripple | | 100 mA rms |
| Remote ON/OFF | | (See Note 1) |
| Start-up time | | 15 ms |

EMC CHARACTERISTICS

| | |
|-------------------------|-----------------------|
| Electrostatic discharge | EN61000-4-2, IEC801-2 |
| Conducted immunity | EN61000-4-6 |
| Radiated immunity | EN61000-4-3 |

GENERAL SPECIFICATIONS

| | | |
|-------------------------|------------------|---|
| Efficiency | | 94% typ. |
| Insulation voltage | | Non-isolated |
| Switching frequency | | 1 MHz |
| Approvals and standards | | EN60950 UL/cUL60950 |
| Material flammability | | UL94V-0 |
| Dimensions | (LxWxH) | 38.10 x 8.50 x 12.00 mm 1.5 x 0.335 x 0.472 inches |
| Pin Length | | 0.140 in (3.56 mm) |
| Weight | | 4 g (0.15 oz) |
| MTBF | Telcordia SR-332 | 10,000,000 hours |

ENVIRONMENTAL SPECIFICATIONS

| | | |
|---------------------|--------------------------------|-------------------|
| Thermal performance | Operating ambient, temperature | -40 °C to +85 °C |
| (See Note 2) | Non-operating | -40 °C to +125 °C |

PROTECTION

| | |
|---------------|--------------------|
| Short-circuit | Continuous |
| Thermal | Automatic recovery |



SIL12F Series

3.3 Vin to 5 Vin single output



DC-DC CONVERTERS

F Class Non-isolated

2

For the most current data and application support visit www.artesyn.com/powergroup/products.htm**NEW Product**

| OUTPUT POWER (MAX.) | INPUT VOLTAGE | OUTPUT VOLTAGE | OUTPUT CURRENT (MIN.) | OUTPUT CURRENT (MAX.) | EFFICIENCY (TYP.) | REGULATION | | MODEL NUMBER ^(6,7) |
|---------------------|---------------|----------------|-----------------------|-----------------------|-------------------|------------|-------|-------------------------------|
| | | | | | | LINE | LOAD | |
| 39.6 W | 3.0-5.5 Vdc | 0.9 3.3 Vdc | 0 A | 12 A | 94% | ±1.0% | ±1.0% | SIL12F-05W3V3-VJ |

Part Number System with Options

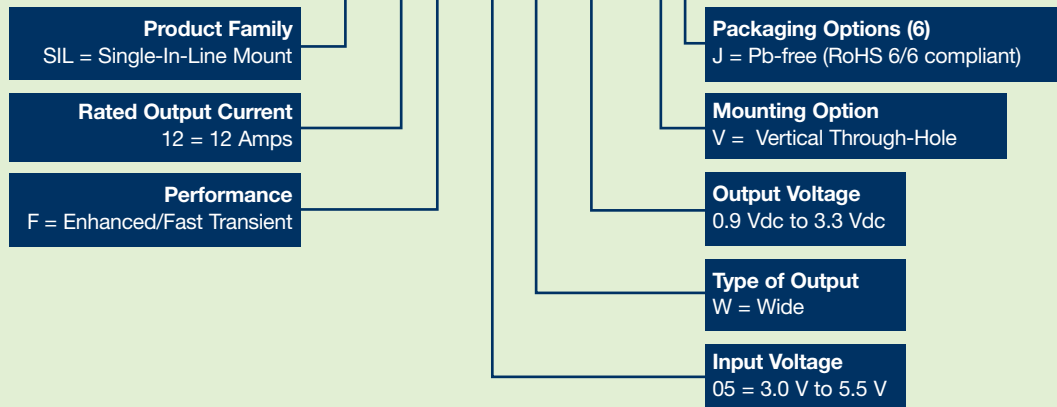
SIL12F-05W3V3-VJ**Output Voltage Adjustment of the SIL12F Series**

The ultra-wide output voltage trim range offers major advantages to users who select the SIL12F-05W3V3-VJ. It is no longer necessary to purchase a variety of modules in order to cover different output voltages. The output voltage can be trimmed in a range of 0.9 Vdc to 3.3 Vdc. When the SIL12F-05W3V3-VJ converter leaves the factory the output has been adjusted to the default voltage of 3.3 V.

- When $V_{in} \geq 4.5$ V, then V_{out} can be adjusted from 0.9 Vdc to 3.3 Vdc
- When $V_{in} < 4.5$ V, then V_{out} can be adjusted from 0.9 Vdc to 2.5 Vdc

Notes

- 1 The SIL12F-05 features an 'Active Low' Remote ON/OFF operation. If you are not using the Remote ON/OFF pin, leave the pin open (the converter will be on). The Remote ON/OFF pin is referenced to ground.

The following conditions apply for the SIL12F-05:

| Configuration | Converter Operation |
|-------------------------|---------------------|
| Remote pin open circuit | Unit is ON |
| Remote pin pulled low | Unit is ON |
| Remote pin pulled high | Unit is OFF |

An 'Active High' Remote ON/OFF version is also possible with this converter. To order please place the suffix 'R' towards the end of the part number, e.g. SIL12F-05W3V3-VRJ.

- 2 See Figures 1, 2 and 3 for derating curves.

Notes Cond.

- 3 A 22 μ F ceramic input capacitor may be required for test purposes only. See Application Note 181 for further details.
- 4 An external output capacitor is required for basic operation. Required capacitance is a minimum of 110 μ F to meet the performance parameters. This can be made up of any combination of 22 μ F or 47 μ F multi-layer ceramic capacitors in 1210 case sizes.
- 5 Ripple and Noise is worst case measurement. Typical value is 25 mV pk-pk.
- 6 TSE RoHS 5/6 (non Pb-free) compliant versions may be available on special request, please contact your local sales representative for details.
- 7 NOTICE: Some models do not support all options. Please contact your local Artesyn representative or use the on-line model number search tool at <http://www.artesyn.com/powergroup/products.htm> to find a suitable alternative.

International Safety Standard Approvals

UL/cUL CAN/CSA 22.2 No. E174104
UL 60950 File No. E174104



TÜV Product Service (EN60950) Certificate No. TBD.
CB Report and Certificate to IEC60950

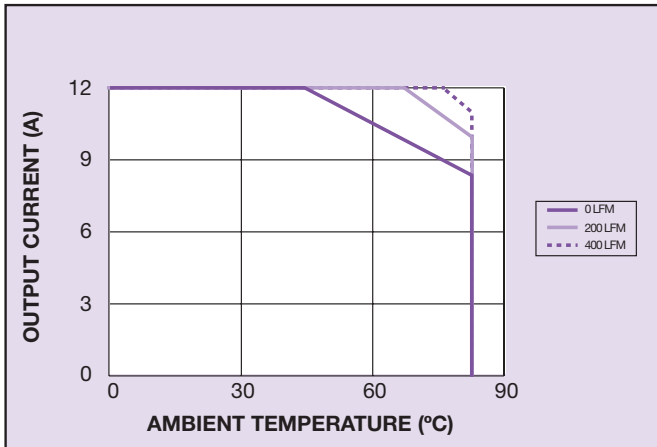

Figure 1 - Derating Curve
 Vin = 3.3 V, Output Voltage = 0.9 V (See Note A)

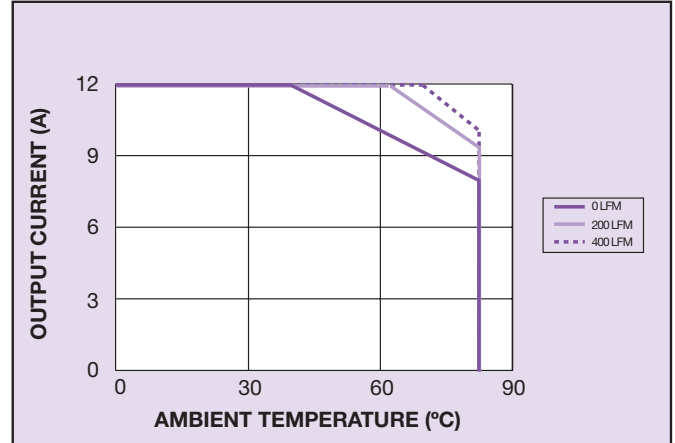

Figure 2 - Derating Curve
 Vin = 5 V, Output Voltage = 3.3 V (See Note A)

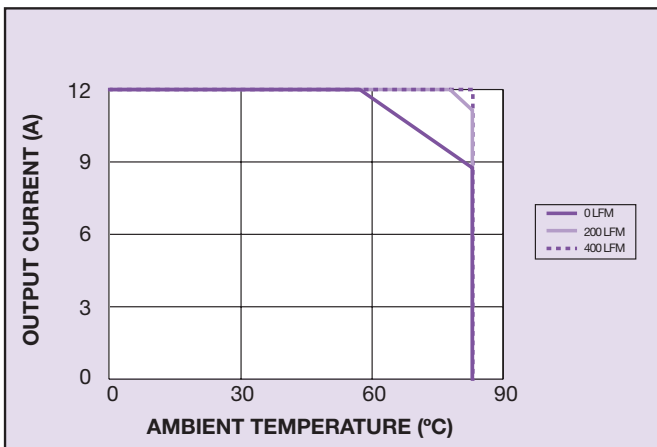

Figure 3 - Derating Curve
 Vin = 5 V, Output Voltage = 0.9 V (See Note A)

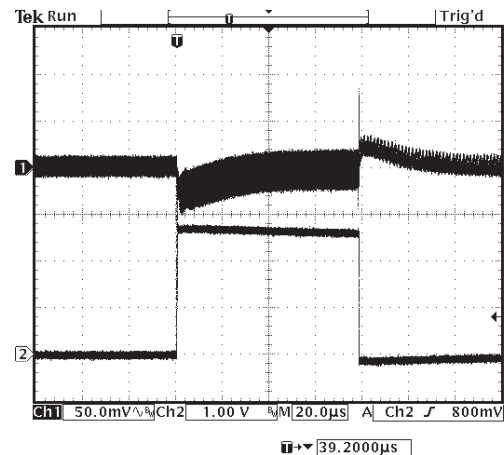

Figure 4 - Typical Transient Response (source)
 (Vin = 5 V, Vout = 2.5 V),
 10 A Load Step di/dt = 200 A/µs
 Channel 1: Deviation on O/P = 5.6%; Settling Time = 40 µs

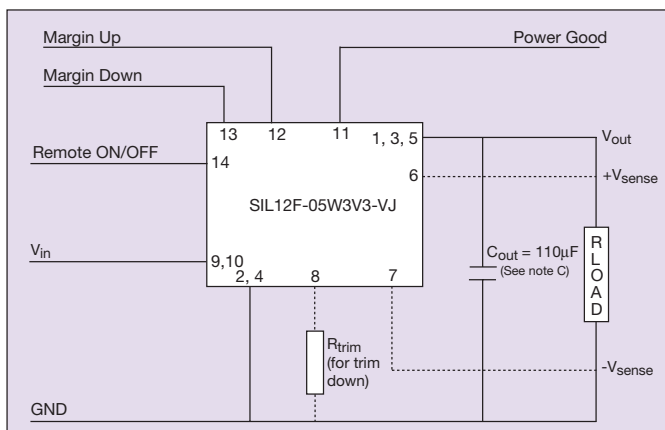

Figure 5 - Standard Application Drawing

Notes

- A** Derating curves represent the conditions at which internal components are within the Artesyn derating guidelines.
- B** External output capacitance is required for basic operation. Required capacitance is a minimum of 110 µF to meet the performance parameters. This can be made up of any combination of 22 µF or 47 µF multi-layer ceramic capacitors in 1210 case sizes.

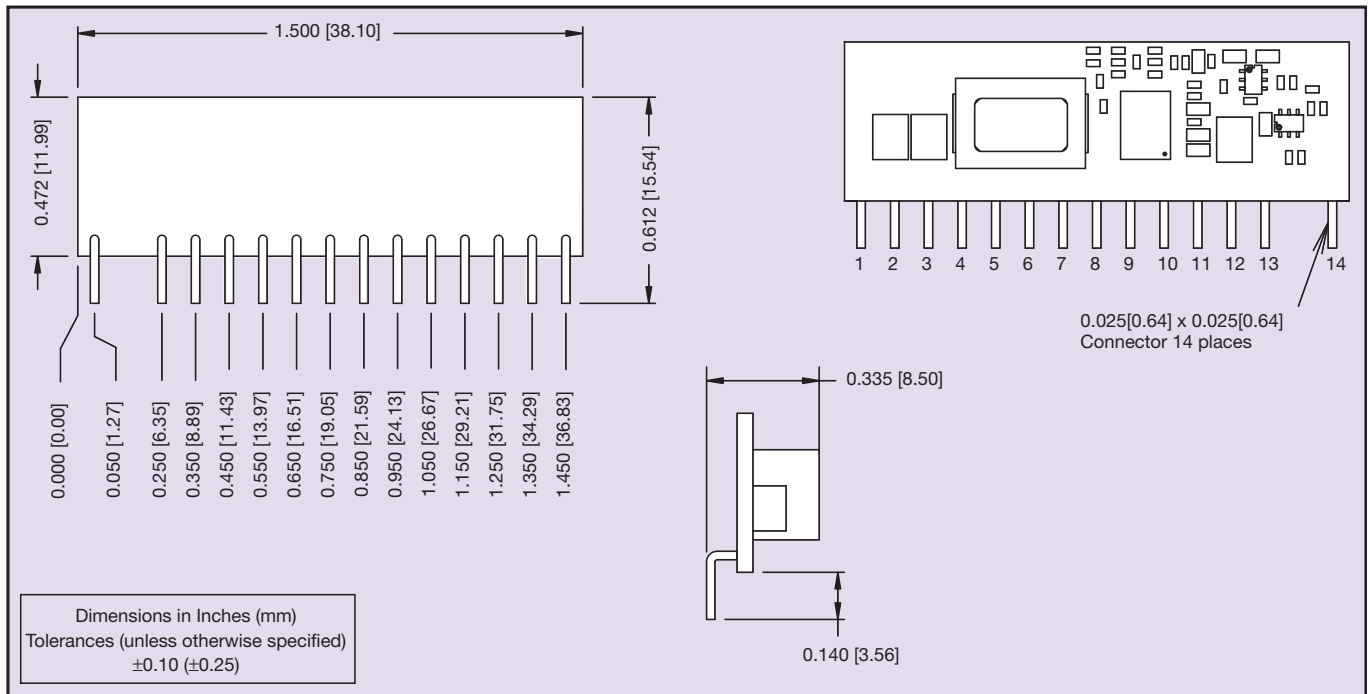

Figure 6 - Mechanical Drawing

Pin No. Pin Description

- 1, 3, 5** **+Vout:** The regulated positive power output with respect to the GND node.
- 2, 4** **Ground:** This is the common ground connection for the Vin and Vout power connections. It is also the 0 Vdc reference for the control inputs.
- 6** **V sense +:** The sense input allows the regulation circuit to compensate for voltage drop between the module and the load. For optimal voltage accuracy Vo Sense should be connected to Vout node of bypass capacitor. It can also be left disconnected.
- 7** **V sense -:** The VSense should be connected to the ground of a bypass capacitor near the load or left open circuit.
- 8** **Trim:** A 1% 0.1 W resistor must be directly connected between this pin and pin 2 (GND) to set the output voltage to a lower value than 3.3 V. The temperature stability of the resistor should be 100 ppm/°C or better. The set point range is from 3.3 V to 0.9 V. The resistor required for a given output voltage may be calculated from the following formula:

$$R_{set} = \frac{110 \times V_{out} \text{ (Desired)}}{3.28 - V_{out} \text{ (Desired)}} \text{ k}\Omega$$

Pin No. Pin Description

- If left open circuit the output voltage will default to 3.3 V. For further information on output voltage adjustment consult the Application Note 181.
- 9, 10** **+Vin:** The positive input voltage power node to the module, which is referenced to common GND.
- 11** **Power Good:** This pin indicates the status of the output voltage. Power Good is driven low if output voltage deviates outside of specified limits.
- 12** **Margin+:** When this input is asserted to High, the output voltage is increased by 5%. This function is independent of trim and sense.
- 13** **Margin-:** When this input is asserted high, the output voltage is decreased by 5% from the nominal. This function is independent of trim and sense.
- 14** **Remote ON/OFF:** Applying a high level signal to this input disables the module's output and turns off the output voltage. When the Remote ON/OFF control is active, the input current drawn by the regulator is significantly reduced. If the Remote ON/OFF pin is left open-circuit, the module will produce an output whenever a valid input source is applied.