

Full-Color Right-Angle SMD (120° Viewing Angle)

OVSRRGBBC9

- Full-color type
- Compatible with automatic placement equipment
- Compatible with infrared and vapor phase reflow solder process

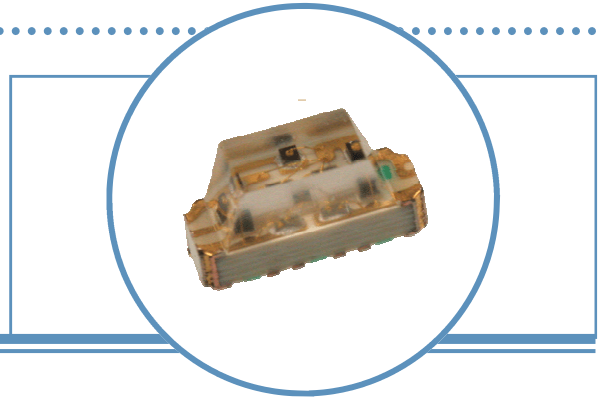

The **OVSRRGBBC9** is a compact full-color (RGB) right-angle surface mount LED with a 120° viewing angle. The device can be used in smaller boards with a higher packing density, which reduces storage space and makes it practical for use in miniature and portable applications.

Applications

- Automotive backlighting for dashboard and switches
- Telecommunications (backlighting for telephones and faxes)
- Flat backlight for LCD, switch and symbol

Part Number	Material	Emitted Color	Intensity Typ. mcd	Lens Color
OVSRRGBBC9	AllInGaN	Red	72 mcd	Water Clear
	InGaN	Green	180 mcd	
	InGaN	Blue	45 mcd	

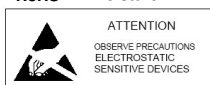
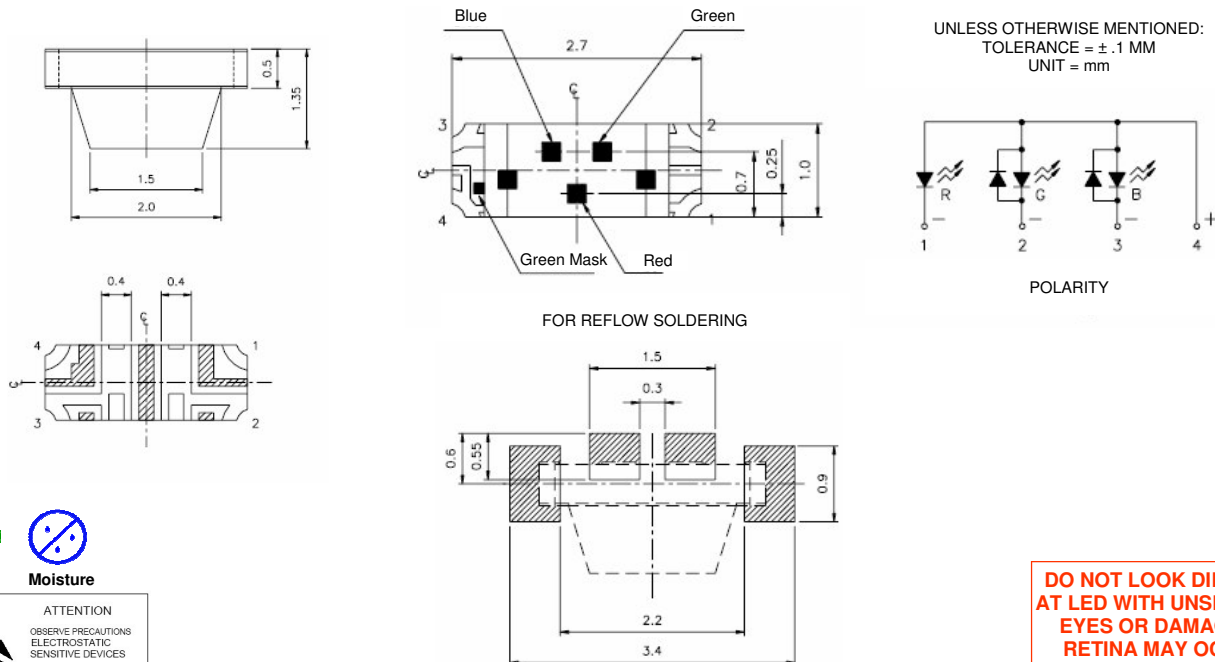

OPTEK reserves the right to make changes at any time in order to improve design and to supply the best product possible.

Absolute Maximum Ratings

T_A = 25° C (on metal core PCB¹) unless otherwise noted

Storage Temperature Range	-40 ~ +90° C
Operating Temperature Range	-40 ~ +85° C
Reverse Voltage	5 V
Continuous Forward Current	25 mA
Peak Forward Current (10% Duty Cycle, 1KHz)	Red = 60 mA Green = 100 mA Blue = 100 mA
Power Dissipation	Red = 60 mW Green = 110 mW Blue = 110 mW
Soldering Temperature (for 5 seconds)	+260° C

Electrical Characteristics

RED						
SYMBOL	PARAMETER	MIN	TYP	MAX	UNITS	CONDITIONS
I _V	Luminous Intensity (axial direction)	45	72	----	mcd	I _F = 20 mA
2 Θ _{1/2}	Viewing Angle	----	120	----	deg	I _F = 20 mA
λ _P	Peak Wavelength	----	632	----	nm	I _F = 20 mA
λ _D	Dominant Wavelength	615	----	630	nm	I _F = 20 mA
Δλ	Spectrum Radiation Bandwidth	----	20	----	nm	I _F = 20 mA
V _F	Forward Voltage	----	2.0	2.4	V	I _F = 20 mA
I _R	Reverse Current	----	----	10	μA	V _R = 5 V

Electrical Characteristics

GREEN						
SYMBOL	PARAMETER	MIN	TYP	MAX	UNITS	CONDITIONS
I _V	Luminous Intensity (axial direction)	112	180	----	mcd	I _F = 20 mA
2 Θ _{1/2}	Viewing Angle	----	120	----	deg	I _F = 20 mA
λ _P	Peak Wavelength	----	518	----	nm	I _F = 20 mA
λ _D	Dominant Wavelength	510	----	540	nm	I _F = 20 mA
Δλ	Spectrum Radiation Bandwidth	----	35	----	nm	I _F = 20 mA
V _F	Forward Voltage	----	3.3	3.9	V	I _F = 20 mA
I _R	Reverse Current	----	----	50	μA	V _R = 5 V

Notes:

1. Luminous intensity tolerance is ± 10%.
2. Dominant wavelength tolerance is ± 1 nm.
3. Forward voltage tolerance is ± 0.1 V.

OPTeK reserves the right to make changes at any time in order to improve design and to supply the best product possible.

Electrical Characteristics

BLUE						
SYMBOL	PARAMETER	MIN	TYP	MAX	UNITS	CONDITIONS
I_V	Luminous Intensity (axial direction)	28.5	45	----	mcd	$I_F = 20 \text{ mA}$
$2 \Theta_{1/2}$	Viewing Angle	----	120	----	deg	$I_F = 20 \text{ mA}$
λ_P	Peak Wavelength	----	468	----	nm	$I_F = 20 \text{ mA}$
λ_D	Dominant Wavelength	460	----	480	nm	$I_F = 20 \text{ mA}$
$\Delta\lambda$	Spectrum Radiation Bandwidth	----	35	----	nm	$I_F = 20 \text{ mA}$
V_F	Forward Voltage	----	3.3	3.9	V	$I_F = 20 \text{ mA}$
I_R	Reverse Current	----	----	50	μA	$V_R = 5 \text{ V}$

Notes:

1. Luminous intensity tolerance is $\pm 10\%$.
2. Dominant wavelength tolerance is $\pm 1 \text{ nm}$.
3. Forward voltage tolerance is $\pm 0.1 \text{ V}$.

OPTEK reserves the right to make changes at any time in order to improve design and to supply the best product possible.

Typical Electro-Optical Characteristics Curves – Red

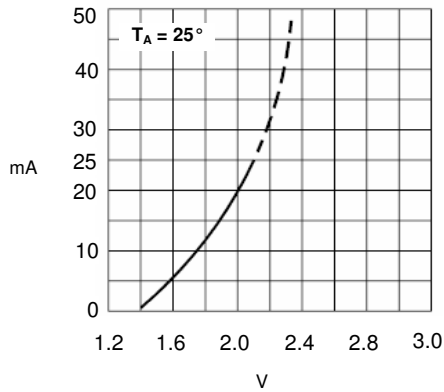

Forward Current vs Forward Voltage

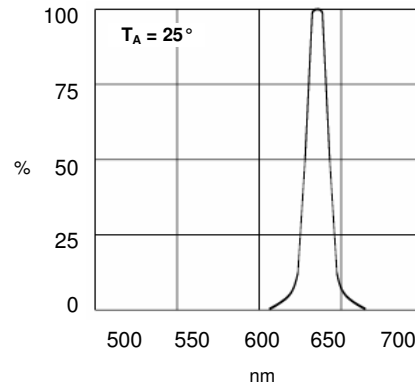

Relative Luminous Intensity vs Wavelength

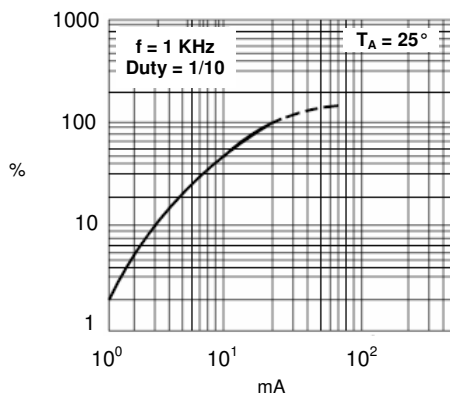

Relative Luminous Intensity vs Forward Current

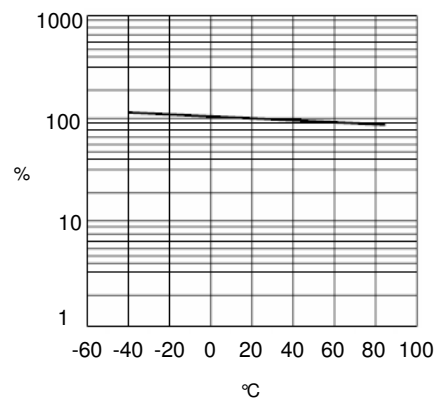

Relative Luminous Intensity vs Ambient Temperature

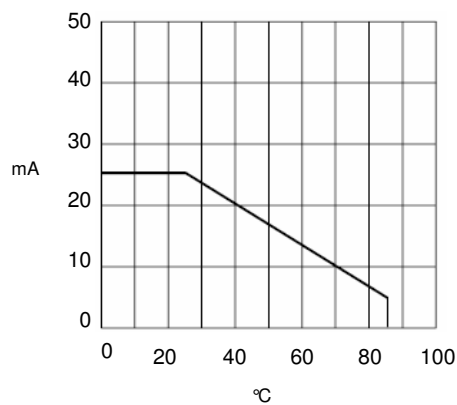

Forward Current vs Ambient Temperature

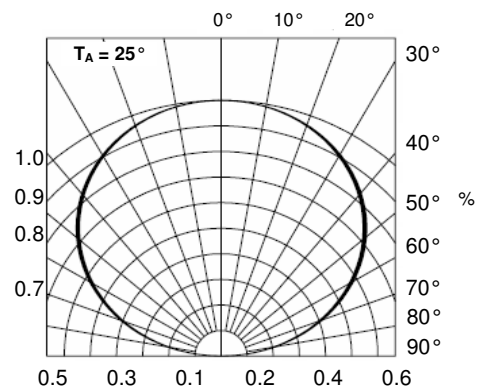

Radiation Diagram

OPTEK reserves the right to make changes at any time in order to improve design and to supply the best product possible.

Typical Electro-Optical Characteristics Curves – Green

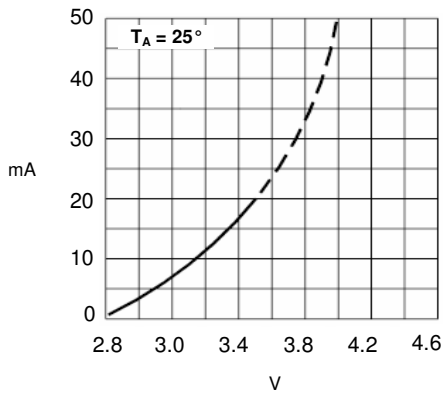

Forward Current vs Forward Voltage

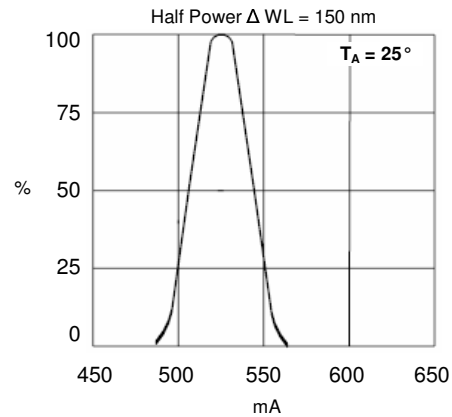

Relative Luminous Intensity vs Wavelength

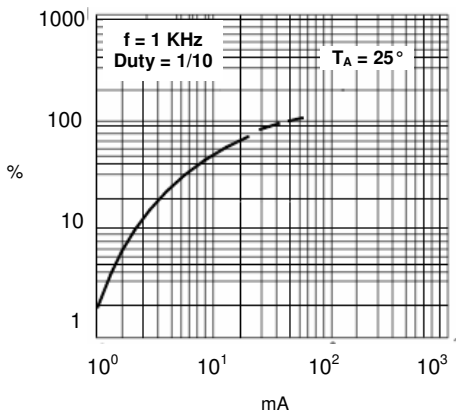

Relative Luminous Intensity vs Forward Current

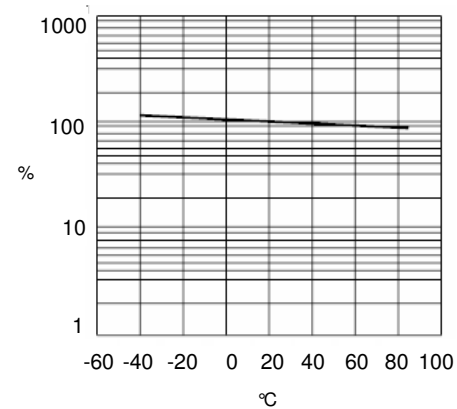

Relative Luminous Intensity vs Ambient Temperature

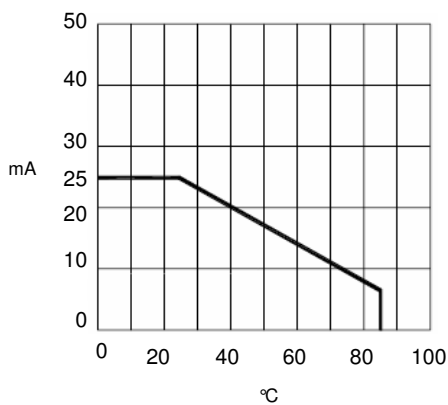

Forward Current vs Ambient Temperature

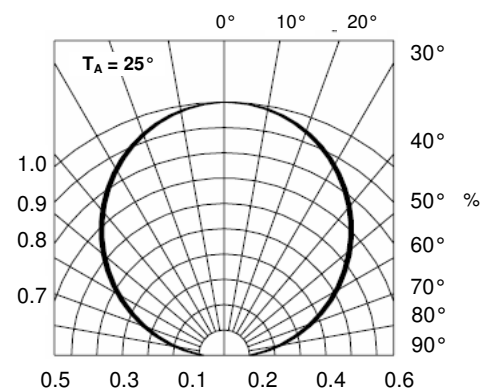

Radiation Diagram

OPTEK reserves the right to make changes at any time in order to improve design and to supply the best product possible.

Typical Electro-Optical Characteristics Curves – Blue

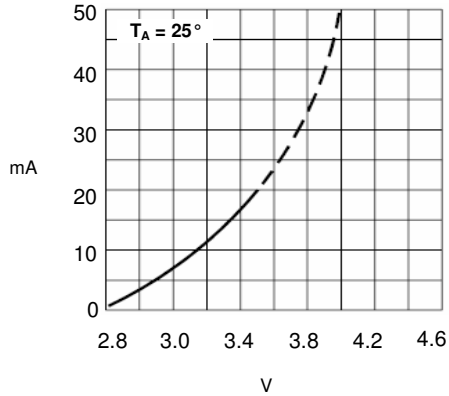

Forward Current vs Forward Voltage

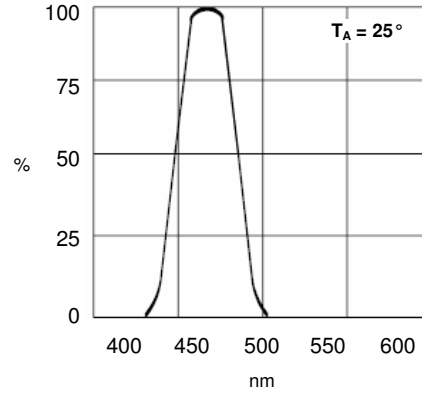

Relative Luminous Intensity vs Wavelength

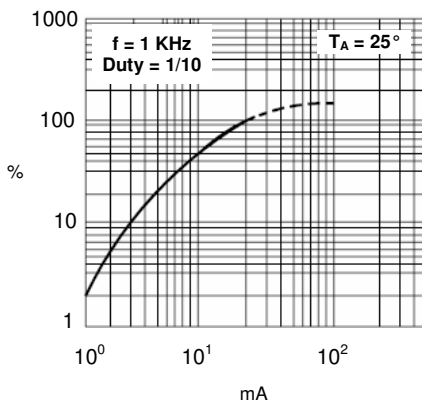

Relative Luminous Intensity vs Forward Current

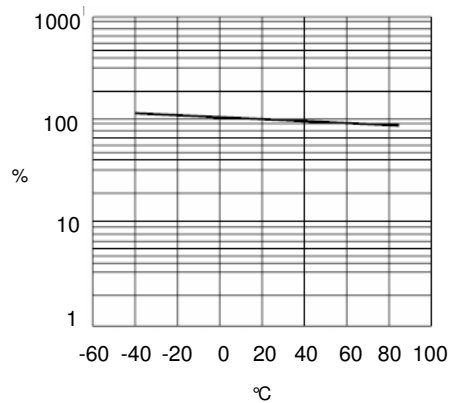

Relative Luminous Intensity vs Ambient Temperature

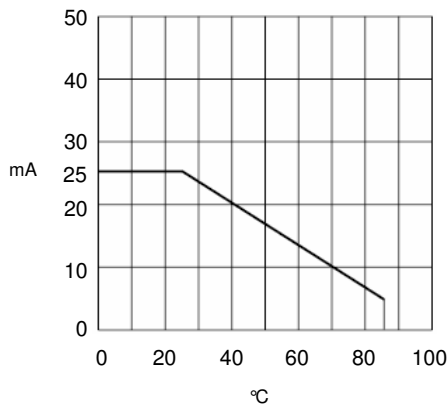

Forward Current vs Ambient Temperature

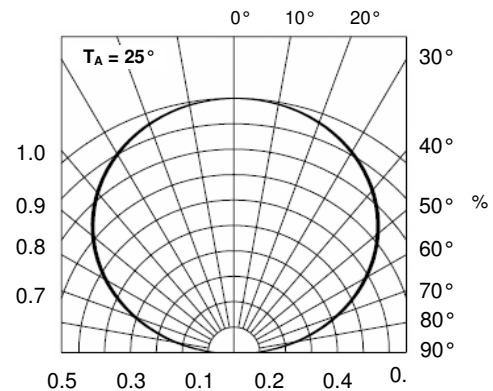

Radiation Diagram

OPTEK reserves the right to make changes at any time in order to improve design and to supply the best product possible.

Full-Color Right-Angle SMD OVSRRGBBC9

Reel Dimensions: 7-inch reel

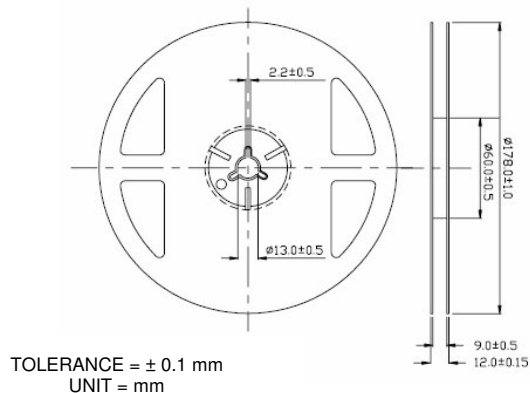

Carrier Tape Dimensions: Loaded quantity 2000 pieces per reel

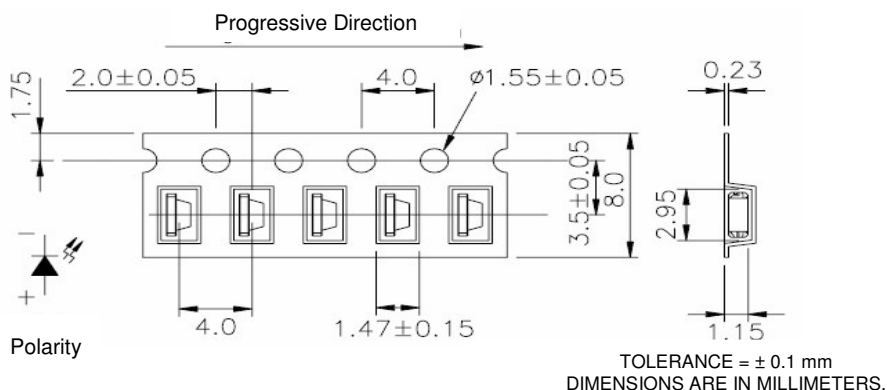

Moisture Resistant Packaging

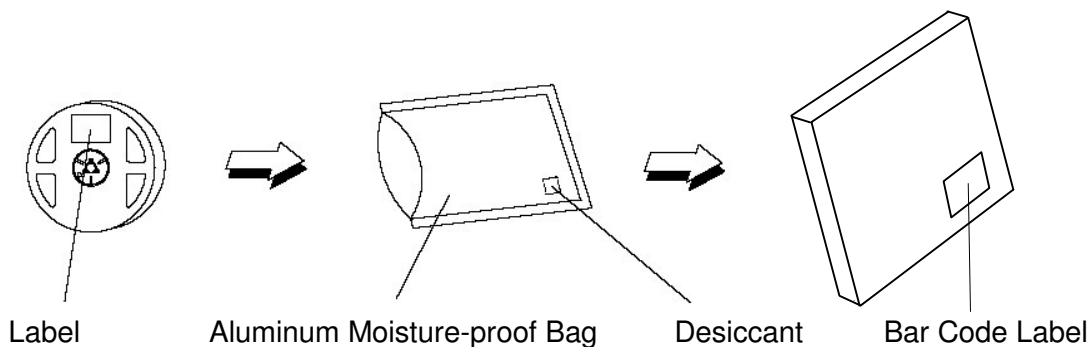

OPTEK reserves the right to make changes at any time in order to improve design and to supply the best product possible.