

GI3055S

N-CHANNEL ENHANCEMENT MODE POWER MOSFET

BVDSS	20V
RDS(ON)	25mΩ
ID	18A

Description

The GI3055S provide the designer with the best combination of fast switching, ruggedized device design, low on-resistance and cost-effectiveness.

The through-hole version (TO-251) is available for low-profile applications and suited for low voltage applications such as DC/DC converters.

Features

- *Low Gate Charge
- *Simple Drive Requirement
- *Fast Switching

Package Dimensions

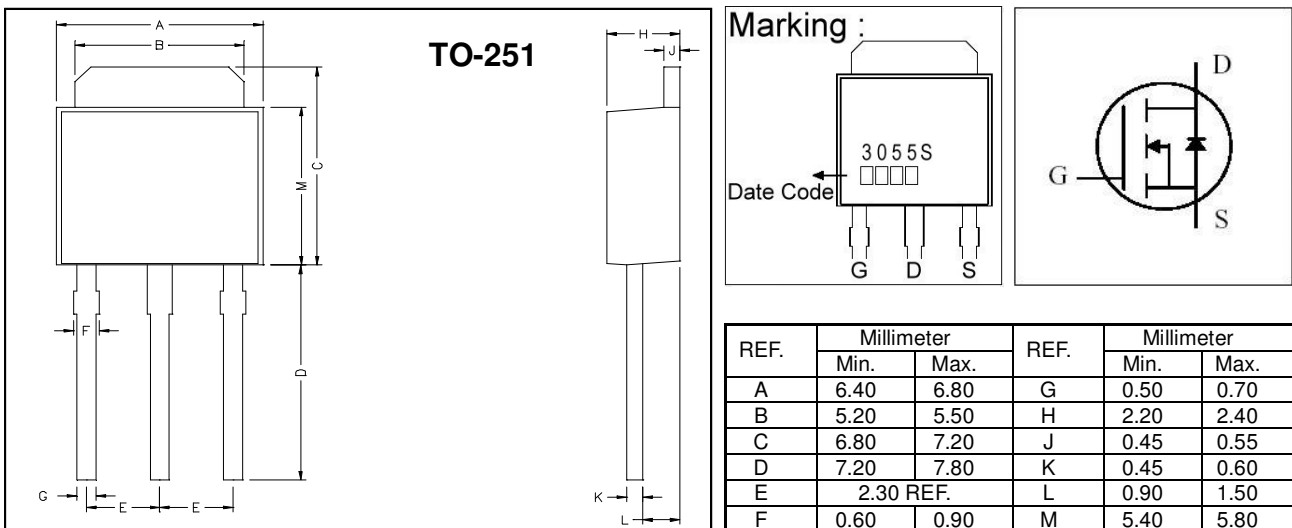

Absolute Maximum Ratings

Parameter	Symbol	Ratings	Unit
Drain-Source Voltage	V_{GS}	20	V
Gate-Source Voltage	V_{GS}	± 8	V
Continuous Drain Current, $V_{GS}@10V$	$I_D @T_C=25^\circ C$	18	A
Continuous Drain Current, $V_{GS}@10V$	$I_D @T_C=100^\circ C$	10	A
Pulsed Drain Current ¹	I_{DM}	30	A
Total Power Dissipation	$P_D @T_C=25^\circ C$	28	W
Linear Derating Factor		0.22	W/ $^\circ C$
Operating Junction and Storage Temperature Range	T_j, T_{stg}	-55 ~ +150	$^\circ C$

Thermal Data

Parameter	Symbol	Value	Unit
Thermal Resistance Junction-case Max.	Rthj-c	4.5	$^\circ C/W$
Thermal Resistance Junction-ambient Max.	Rthj-a	110	$^\circ C/W$

Electrical Characteristics (T_j = 25°C unless otherwise specified)

Parameter	Symbol	Min.	Typ.	Max.	Unit	Test Conditions
Drain-Source Breakdown Voltage	BV _{DSS}	20	-	-	V	V _{GS} =0, I _D =250uA
Breakdown Voltage Temperature Coefficient	$\Delta BV_{DSS} / \Delta T_j$	-	0.037	-	V/°C	Reference to 25°C, I _D =1mA
Gate Threshold Voltage	V _{GS(th)}	0.5	-	1.2	V	V _{DS} =V _{GS} , I _D =250uA
Forward Transconductance	g _{fs}	-	7	-	S	V _{DS} =10V, I _D =6A
Gate-Source Leakage Current	I _{GSS}	-	-	±100	nA	V _{GS} = ±8V
Drain-Source Leakage Current(T _j =25°C)	I _{DSS}	-	-	1	uA	V _{DS} =20V, V _{GS} =0
Drain-Source Leakage Current(T _j =150°C)		-	-	25	uA	V _{DS} =16V, V _{GS} =0
Static Drain-Source On-Resistance	R _{DS(ON)}	-	-	25	mΩ	V _{GS} =10V, I _D =8A
		-	-	30		V _{GS} =4.5V, I _D =6A
		-	-	40		V _{GS} =2.5V, I _D =5.2A
Total Gate Charge ²	Q _g	-	18.9	-	nC	I _D =6A
Gate-Source Charge	Q _{gs}	-	2.1	-		V _{DS} =10V
Gate-Drain ("Miller") Change	Q _{gd}	-	2.4	-		V _{GS} =10V
Turn-on Delay Time ²	T _{d(on)}	-	14.3	-	ns	V _{DS} =10V
Rise Time	T _r	-	11.9	-		I _D =1A
Turn-off Delay Time	T _{d(off)}	-	22.1	-		V _{GS} =4.5V
Fall Time	T _f	-	16.7	-		R _G =6Ω R _L =10Ω
Input Capacitance	C _{iss}	-	614	-	pF	V _{GS} =0V
Output Capacitance	C _{oss}	-	151	-		V _{DS} =8V
Reverse Transfer Capacitance	C _{rss}	-	116	-		f=1.0MHz

Source-Drain Diode

Parameter	Symbol	Min.	Typ.	Max.	Unit	Test Conditions
Forward On Voltage ²	V _{SD}	-	-	1.3	V	I _S =18A, V _{GS} =0V, T _j =25°C
Continuous Source Current(Body Diode)	I _S	-	-	18	A	V _D = V _G =0V, V _S =1.3V
Pulsed Source Current(Body Diode) ¹	I _{SM}	-	-	30	A	

Notes: 1. Pulse width limited by safe operating area.

2. Pulse width ≤ 300us, duty cycle ≤ 2%.

Characteristics Curve

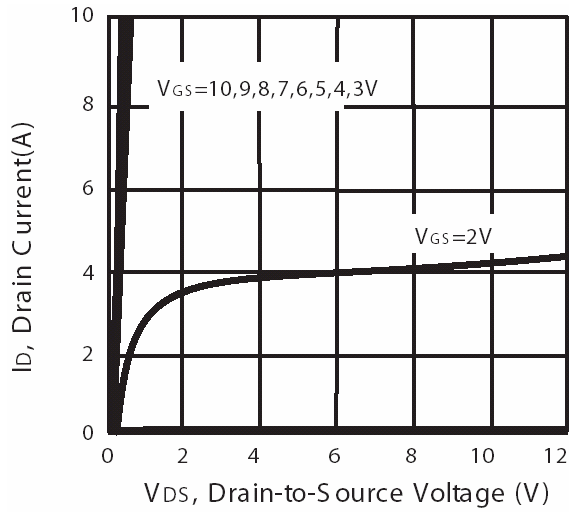

Fig 1. Typical Output Characteristics

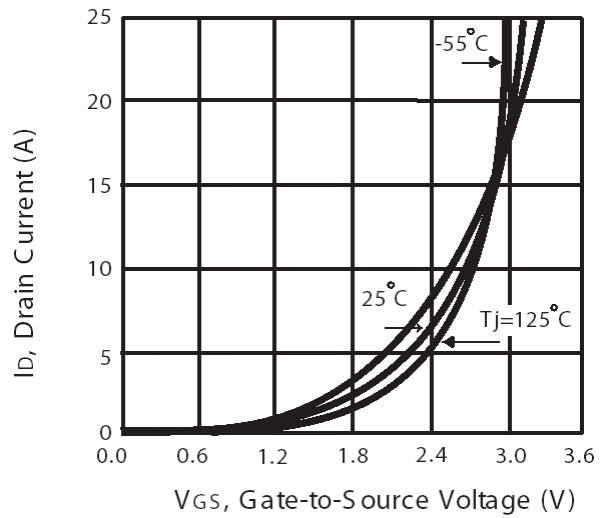

Fig 2. Transfer Characteristics

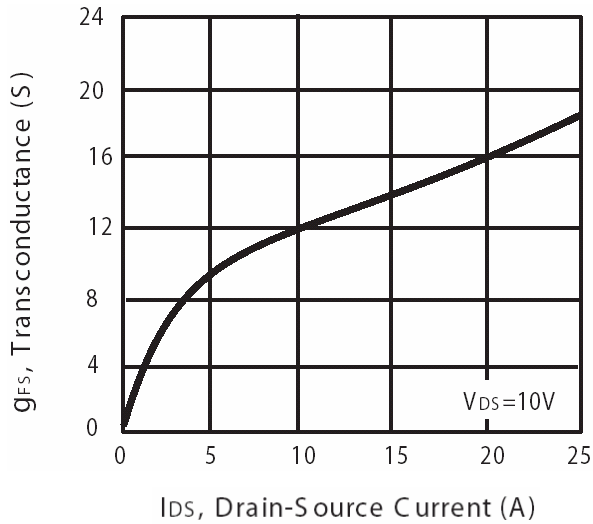

Fig 3. Transconductance v.s. Drain Current

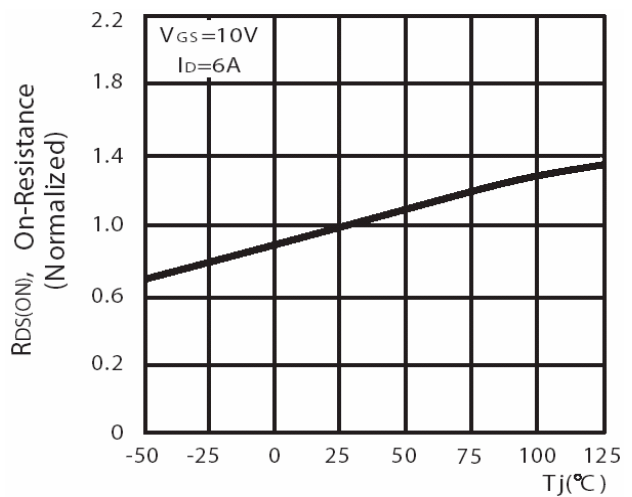

Fig 4. On-Resistance v.s. Junction Temperature

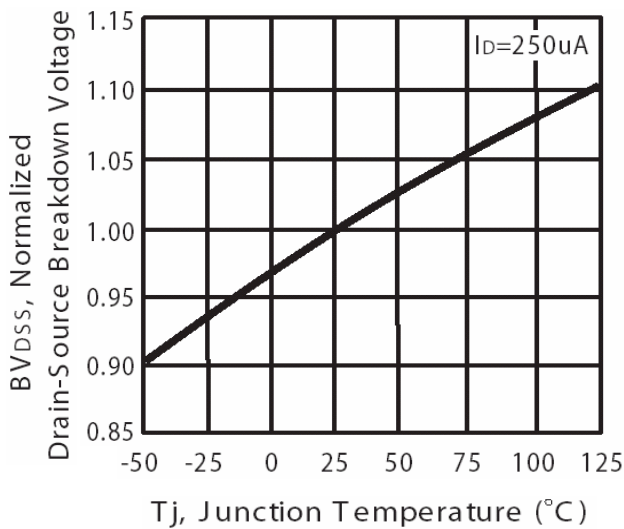

Fig 5. Breakdown Voltage v.s. Junction Temperature

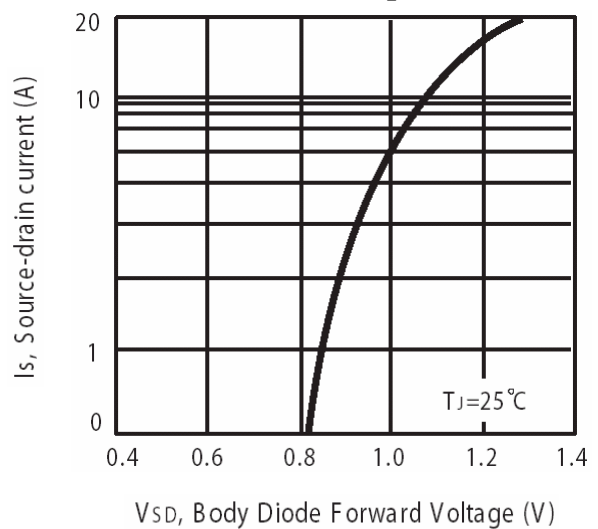

Fig 6. Body Diode Forward Voltage v.s. Source Current

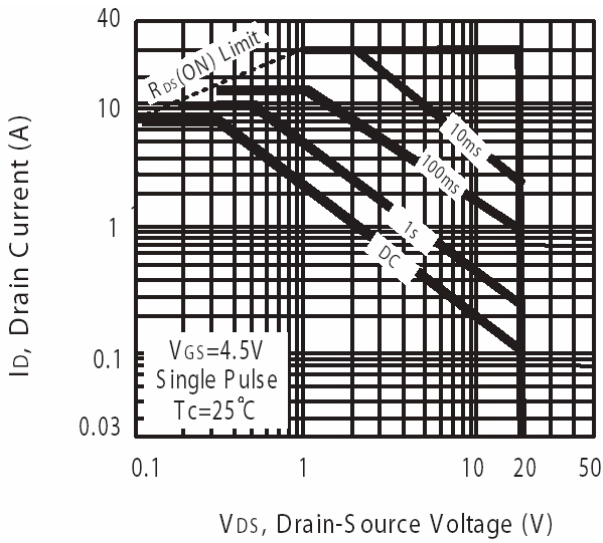

Fig 7. Maximum Safe Operating Area

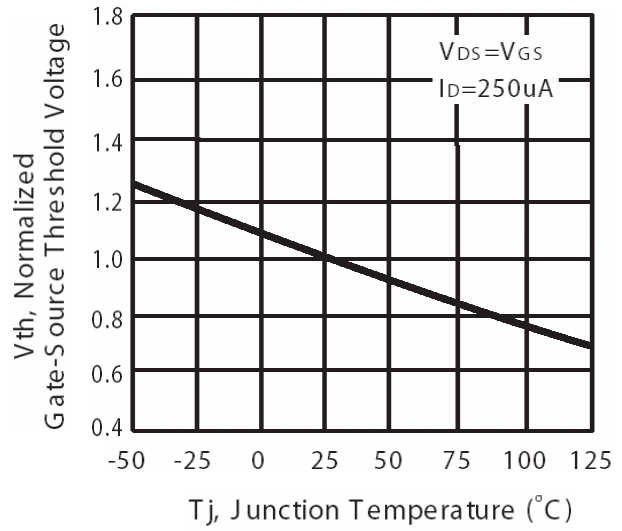

Fig 8. Gate Threshold Voltage v.s. Junction Temperature

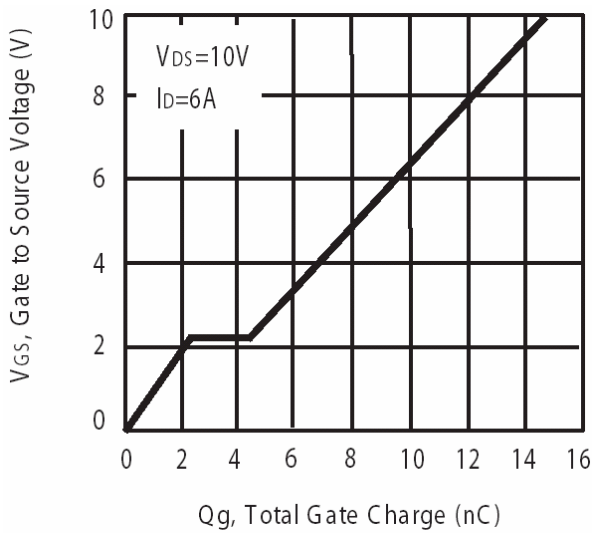

Fig 9. Gate Charge Characteristics

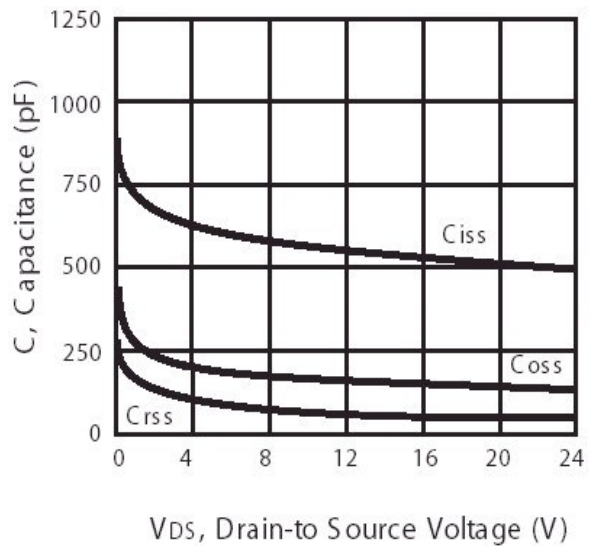

Fig 10. Typical Capacitance Characteristics

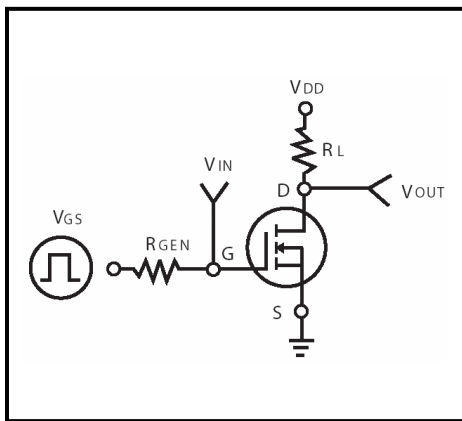

Fig 11. Switching Time Circuit

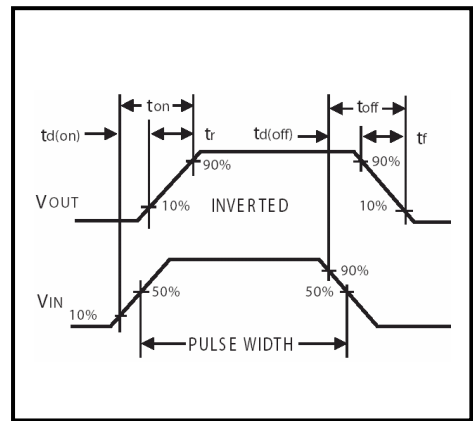

Fig 12. Switching Time Waveform

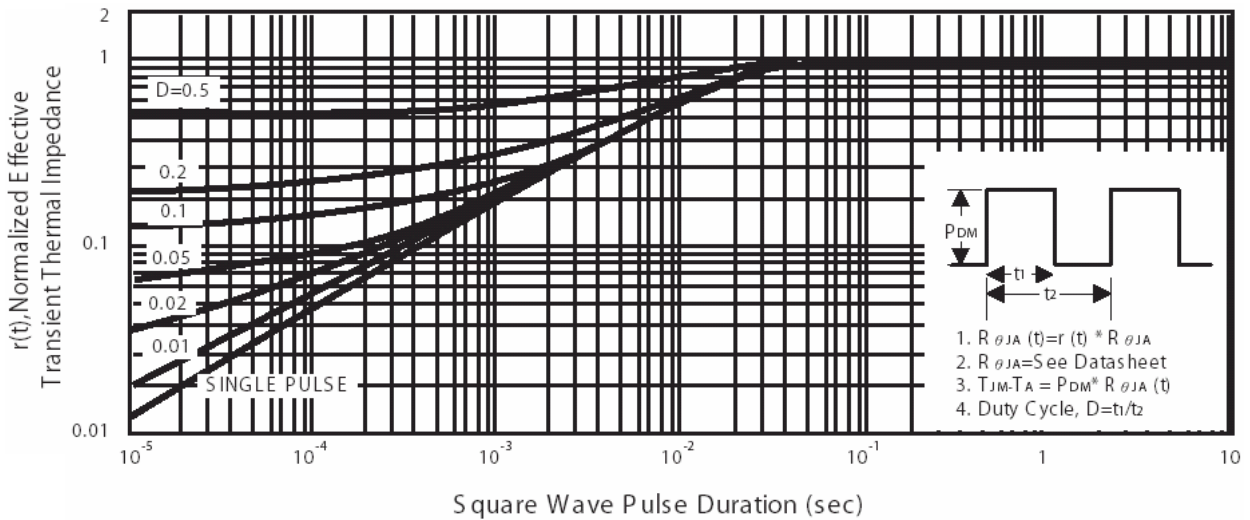

Fig 13. Normalized Thermal Transient Impedance Curve

Important Notice:

- All rights are reserved. Reproduction in whole or in part is prohibited without the prior written approval of GTM.
- GTM reserves the right to make changes to its products without notice.
- GTM semiconductor products are not warranted to be suitable for use in life-support Applications, or systems.
- GTM assumes no liability for any consequence of customer product design, infringement of patents, or application assistance.

Head Office And Factory:

- **Taiwan:** No. 17-1 Tatung Rd. Fu Kou Hsin-Chu Industrial Park, Hsin-Chu, Taiwan, R. O. C.
- TEL : 886-3-597-7061 FAX : 886-3-597-9220, 597-0785
- **China:** (201203) No.255, Jang-Jiang Tsai-Lueng RD. , Pu-Dung-Hsin District, Shang-Hai City, China
- TEL : 86-21-5895-7671 ~ 4 FAX : 86-21-38950165