

High Power RF LDMOS Field Effect Transistor 10 W, 2110 – 2170 MHz

Description

The PTF210101M is an unmatched 10-watt *GOLDMOS*® FET intended for class AB base station applications in the 2110 to 2170 MHz band. This LDMOS device offers excellent gain, efficiency and linearity performance in a small footprint.



PTF210101M
Package PG-RFP-10

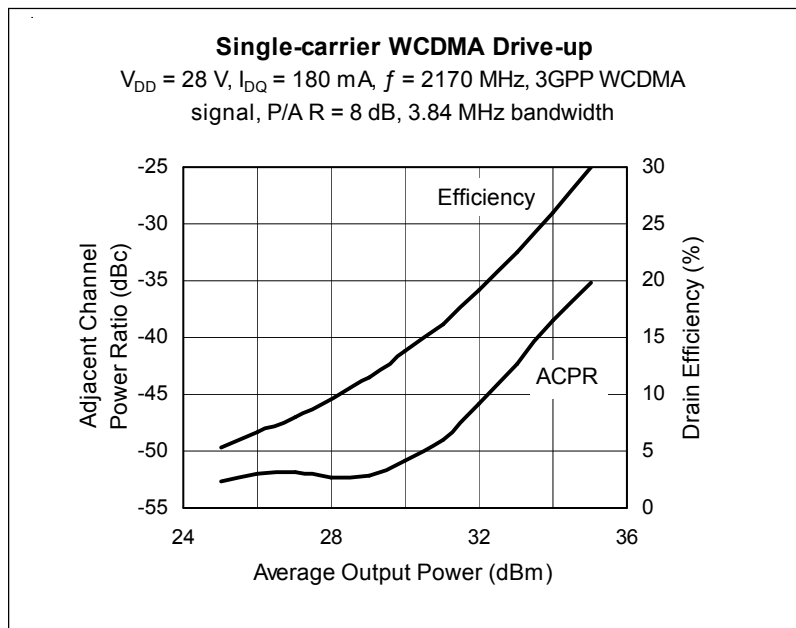

Features

- Typical WCDMA performance
 - Average output power = 2.0 W
 - Gain = 15 dB
 - Efficiency = 20%
 - ACPR = -45 dB
- Typical CW performance
 - Output Power at P-1dB = 10 W
 - Gain = 14 dB
 - Efficiency = 50%
- Integrated ESD protection: Human Body Model Class 1 (minimum)
- Excellent thermal stability
- Low HCI drift
- Capable of handling 10:1 VSWR @ 28 V, 10 W (CW) output power
- Pb-free and RoHS compliant

RF Characteristics

Two-Tone Measurements (not subject to production test—verified by design/characterization in Infineon test fixture)

$V_{DD} = 28\text{ V}$, $I_{DQ} = 180\text{ mA}$, $P_{OUT} = 10\text{ W PEP}$, $f = 2170\text{ MHz}$, tone spacing = 1 MHz

Characteristic	Symbol	Min	Typ	Max	Unit
Gain	G_{ps}	15	—	—	dB
Drain Efficiency	η_D	35	—	—	%
Intermodulation Distortion	IMD	—	—	-28	dBc

All published data at $T_{CASE} = 25^\circ\text{C}$ unless otherwise indicated

ESD: Electrostatic discharge sensitive device—observe handling precautions!

DC Characteristics

Characteristic	Conditions	Symbol	Min	Typ	Max	Unit
Drain-Source Breakdown Voltage	$V_{GS} = 0\text{ V}, I_{DS} = 10\ \mu\text{A}$	$V_{(BR)DSS}$	65	—	—	V
Drain Leakage Current	$V_{DS} = 28\text{ V}, V_{GS} = 0\text{ V}$	I_{DSS}	—	—	1.0	μA
On-State Resistance	$V_{GS} = 10\text{ V}, V_{DS} = 0.1\text{ A}$	$R_{DS(on)}$	—	0.83	—	Ω
Operating Gate Voltage	$V_{DS} = 28\text{ V}, I_{DQ} = 180\text{ mA}$	V_{GS}	2.5	3.2	4.0	V
Gate Leakage Current	$V_{GS} = 10\text{ V}, V_{DS} = 0\text{ V}$	I_{GSS}	—	—	1.0	μA

Maximum Ratings

Parameter	Symbol	Value	Unit
Drain-Source Voltage	V_{DSS}	65	V
Gate-Source Voltage	V_{GS}	-0.5 to +12	V
Junction Temperature	T_J	150	$^{\circ}\text{C}$
Total Device Dissipation	P_D	19	W
Above 25 $^{\circ}\text{C}$ derate by		0.15	W/ $^{\circ}\text{C}$
Storage Temperature Range	T_{STG}	-40 to +150	$^{\circ}\text{C}$
Thermal Resistance ($T_{CASE} = 70^{\circ}\text{C}, 10\text{ W DC}$)	$R_{\theta JC}$	6.5	$^{\circ}\text{C/W}$

Ordering Information

Type	Package Outline	Package Description	Marking
PTF210101M	PG-RFP-10	Molded plastic, SMD	0211

Typical Performance (data taken in production test fixture)

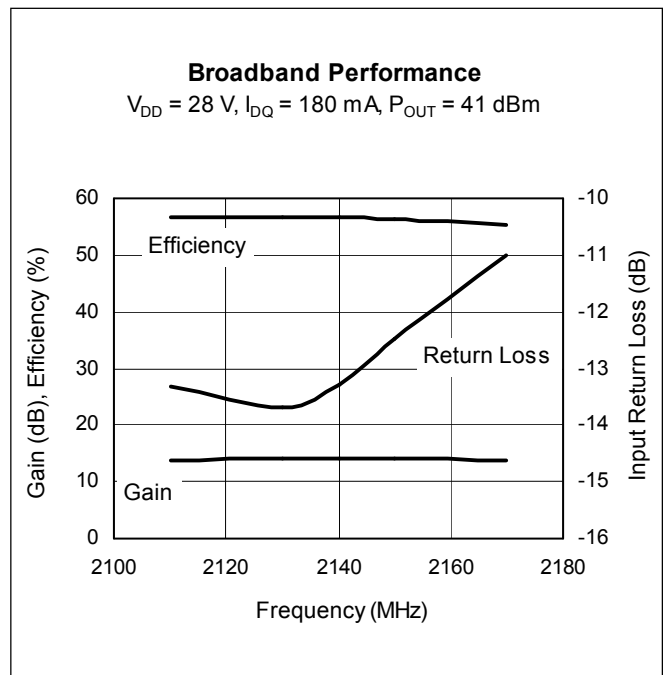
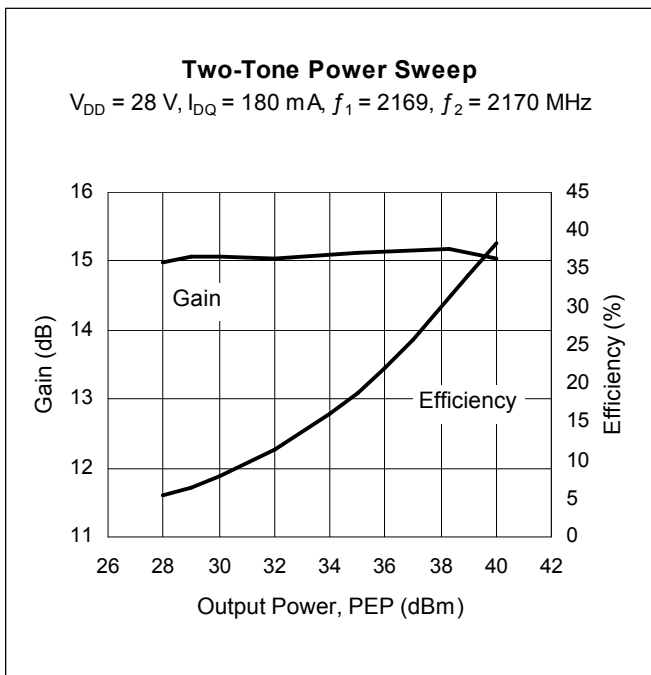
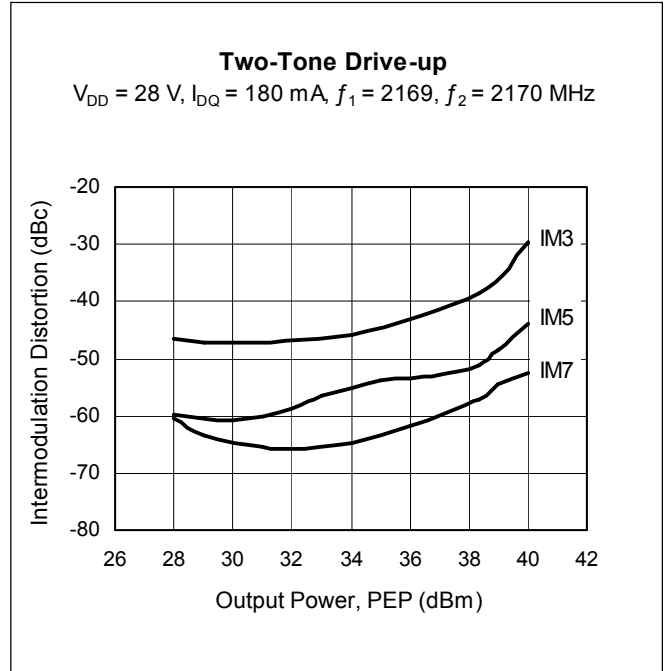
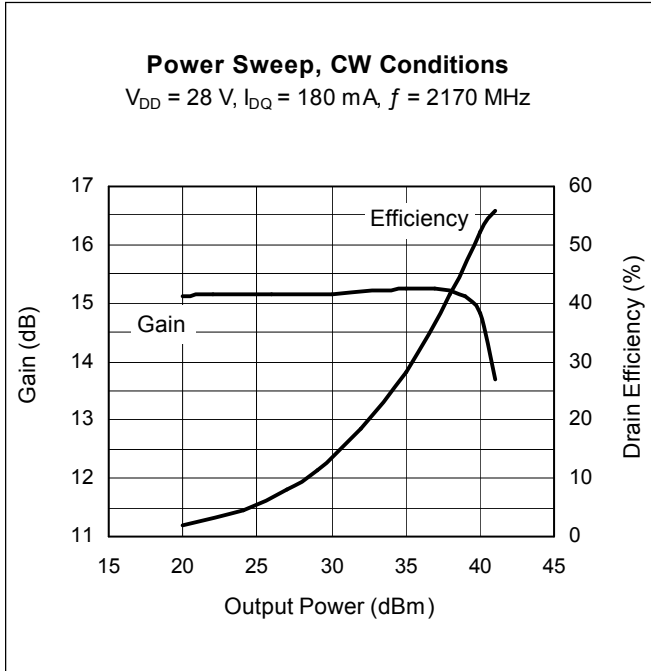

Typical Performance (cont.)

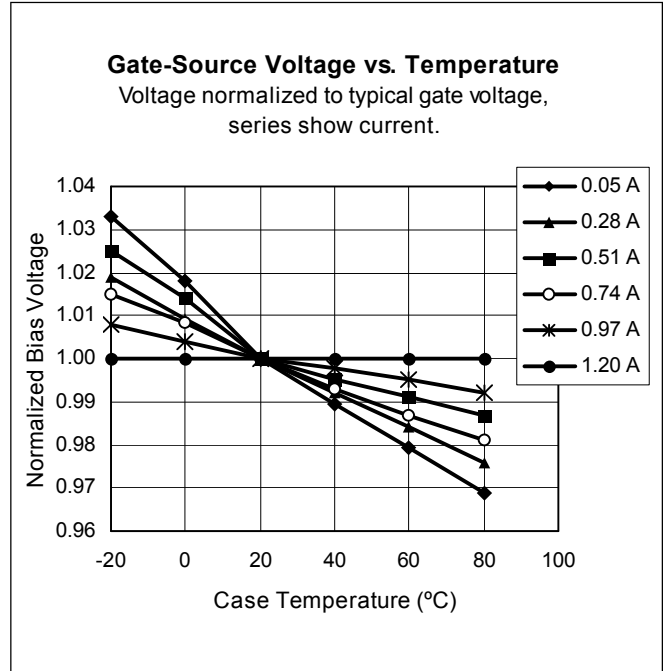
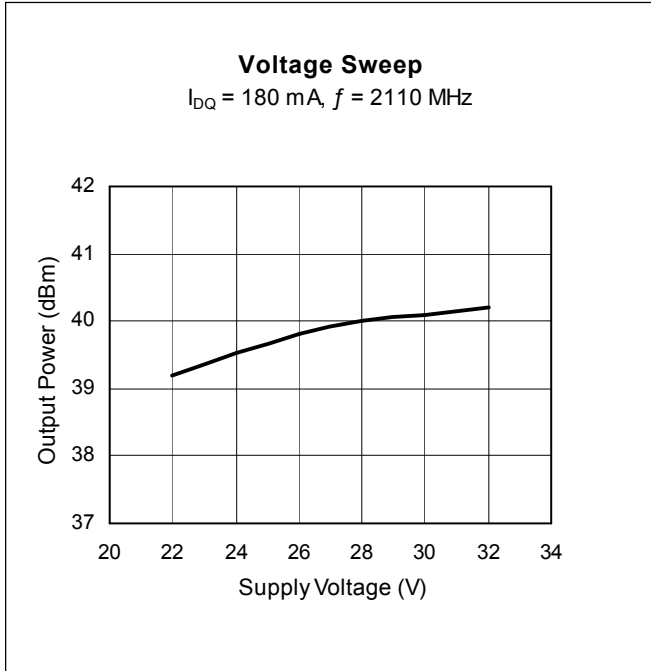

Broadband Circuit Impedance

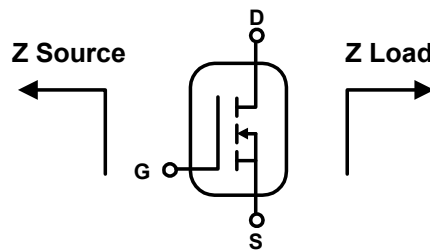

Frequency MHz	Z Source W		Z Load W	
	R	jX	R	jX
2080	2.4	-6.0	2.1	-3.3
2110	2.1	-5.8	2.1	-3.1
2140	1.8	-5.2	2.1	-2.9
2170	1.6	-4.9	2.0	-2.8
2200	1.4	-4.5	2.0	-2.6

Reference Circuit

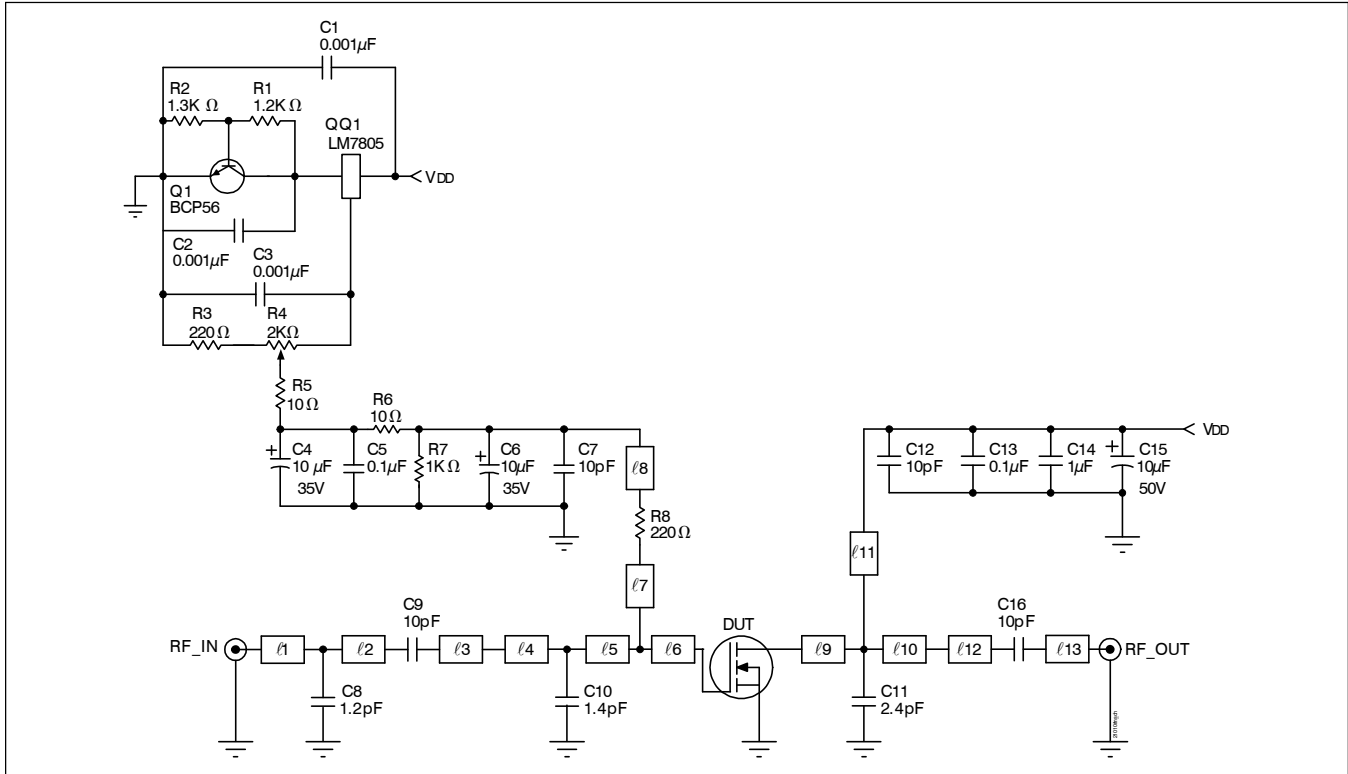

Reference circuit schematic for $f = 2170 \text{ MHz}$

Circuit Assembly Information

DUT	PTF210101M	LDMOS Transistor	
PCB	0.76 mm [.030"] thick, $\epsilon_r = 3.48$	Rogers 4350	1 oz. copper

Microstrip	Electrical Characteristics at 2170 MHz ¹	Dimensions: L x W (mm)	Dimensions: L x W (in.)
l1	0.048 λ , 50.0 Ω	3.99 x 1.63	0.157 x 0.064
l2	0.139 λ , 50.0 Ω	11.63 x 1.63	0.458 x 0.064
l3	0.034 λ , 50.0 Ω	2.84 x 1.63	0.112 x 0.064
l4	0.025 λ , 9.6 Ω	1.93 x 14.27	0.076 x 0.562
l5	0.068 λ , 9.6 Ω	5.21 x 14.27	0.205 x 0.562
l6	0.028 λ , 9.6 Ω	2.16 x 14.27	0.085 x 0.562
l7	0.176 λ , 81.0 Ω	15.11 x 0.69	0.595 x 0.027
l8	0.193 λ , 81.0 Ω	16.66 x 0.69	0.656 x 0.027
l9	0.015 λ , 12.9 Ω	1.19 x 10.16	0.047 x 0.400
l10	0.233 λ , 12.9 Ω	17.93 x 10.16	0.706 x 0.400
l11	0.197 λ , 67.0 Ω	16.76 x 1.02	0.660 x 0.040
l12	0.020 λ , 50.0 Ω	1.68 x 1.63	0.066 x 0.064
l13	0.072 λ , 50.0 Ω	6.68 x 1.63	0.263 x 0.064

¹Electrical characteristics are rounded.

Reference Circuit (cont.)

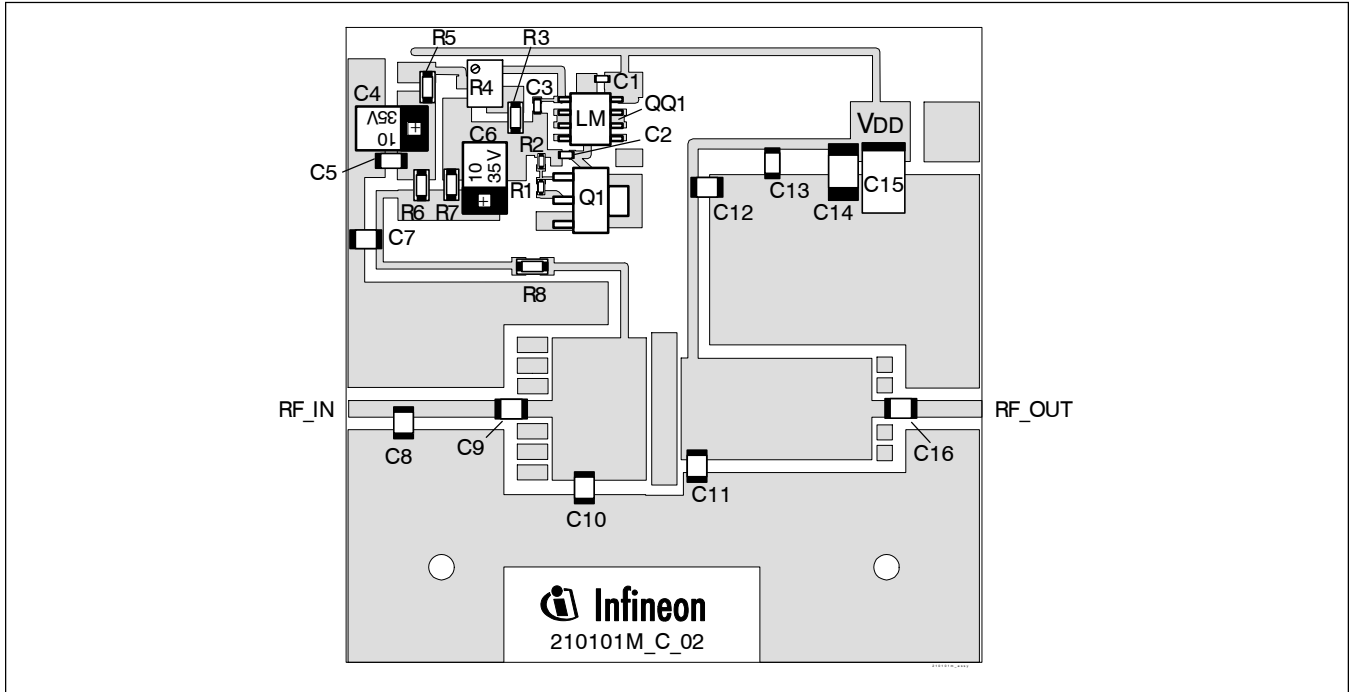

Reference circuit assembly diagram (not to scale)*

Component	Description	Suggested Manufacturer	P/N or Comment
C1, C2, C3	Capacitor, 0.001 μ F	Digi-Key	PCC1772CT-ND
C4, C6	Tantalum capacitor, 10 μ F, 35 V	Digi-Key	PCS6106TR-ND
C5, C13	Capacitor, 0.1 μ F	Digi-Key	PCC104BCT-ND
C7, C9, C12, C16	Ceramic capacitor, 10 pF	ATC	100B 100
C8	Ceramic capacitor, 1.2 pF	ATC	100B 1R2
C10	Ceramic capacitor, 1.4 pF	ATC	100B 1R4
C11	Ceramic capacitor, 2.4 pF	ATC	100B 2R4
C14	Capacitor, 1.0 μ F	ATC	920C105
C15	Tantalum capacitor, 10 μ F, 50 V	Garrett Electronics	TPSE106K050R0400
Q1	Transistor	Infineon Technologies	BCP56
QQ1	Voltage regulator	National Semiconductor	LM7805
R1	Chip Resistor 1.2 k-ohms	Digi-Key	P1.2KGCT-ND
R2	Chip Resistor 1.3 k-ohms	Digi-Key	P1.3KGCT-ND
R3, R8	Chip Resistor 220 ohms	Digi-Key	P221ECT-ND
R4	Potentiometer 2 k-ohms	Digi-Key	3224W-202ETR-ND
R5, R6	Chip Resistor 10 ohms	Digi-Key	P10ECT-ND
R7	Chip Resistor 1 k-ohms	Digi-Key	P1KECT-ND

*Gerber Files for this circuit available on request

Package Outline Specifications

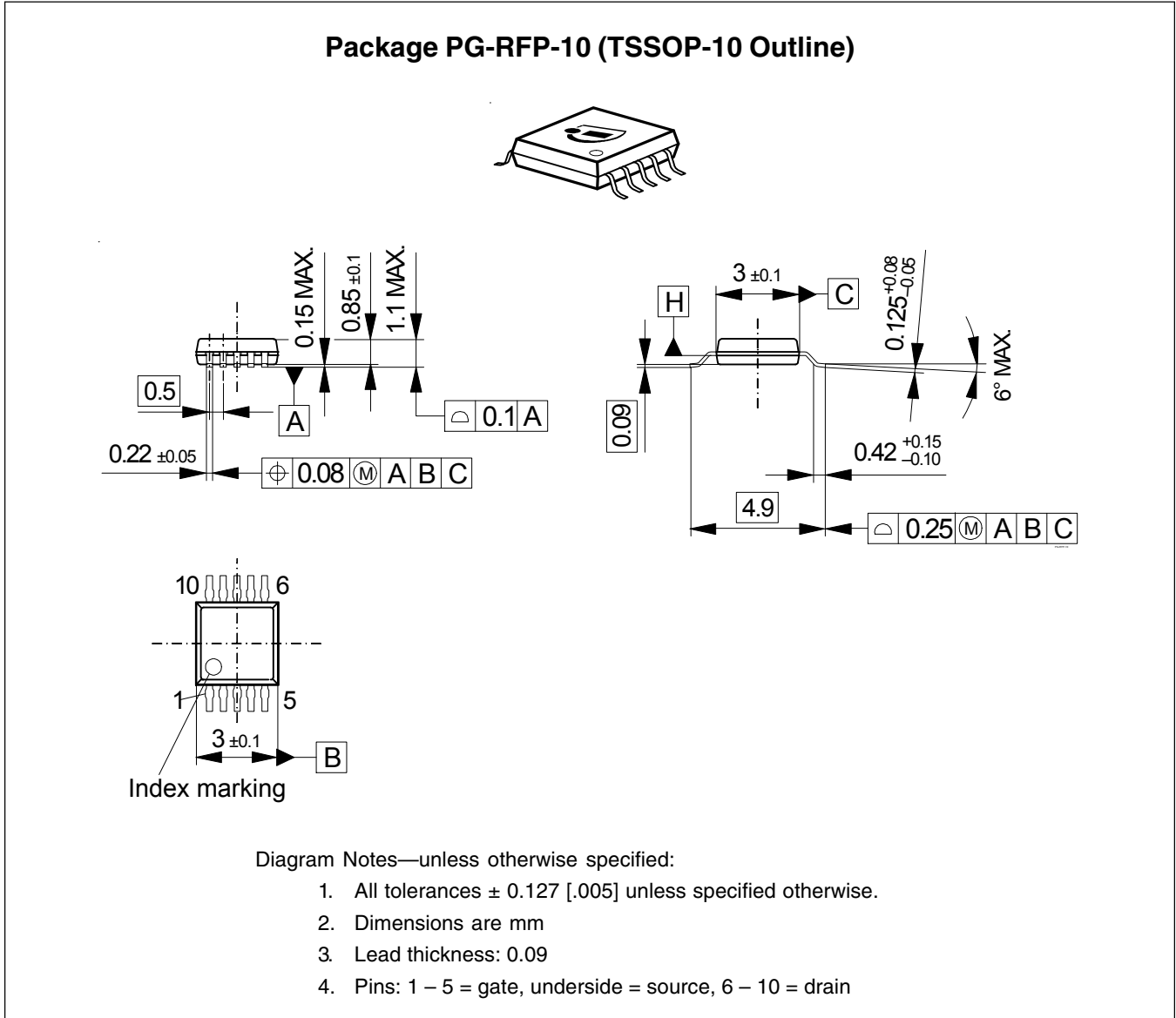

Find the latest and most complete information about products and packaging at the Infineon Internet page <http://www.infineon.com/products>

Revision History: 2009-02-18 Data Sheet

Previous version: 2005-12-05, Data Sheet

Page	Subjects (major changes since last revision)
6	Fixed typing error

We Listen to Your Comments

Any information within this document that you feel is wrong, unclear or missing at all? Your feedback will help us to continuously improve the quality of this document. Please send your proposal (including a reference to this document) to:

highpowerRF@infineon.com

To request other information, contact us at:
+1 877 465 3667 (1-877-GOLDMOS) USA
or +1 408 776 0600 International

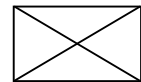

Edition 2009-02-18

Published by
Infineon Technologies AG
81726 Munich, Germany

© 2009 Infineon Technologies AG
All Rights Reserved.

Legal Disclaimer

The information given in this document shall in no event be regarded as a guarantee of conditions or characteristics. With respect to any examples or hints given herein, any typical values stated herein and/or any information regarding the application of the device, Infineon Technologies hereby disclaims any and all warranties and liabilities of any kind, including without limitation, warranties of non-infringement of intellectual property rights of any third party.

Information

For further information on technology, delivery terms and conditions and prices, please contact the nearest Infineon Technologies Office (www.infineon.com/rfpower).

Warnings

Due to technical requirements, components may contain dangerous substances. For information on the types in question, please contact the nearest Infineon Technologies Office.

Infineon Technologies components may be used in life-support devices or systems only with the express written approval of Infineon Technologies, if a failure of such components can reasonably be expected to cause the failure of that life-support device or system or to affect the safety or effectiveness of that device or system. Life support devices or systems are intended to be implanted in the human body or to support and/or maintain and sustain and/or protect human life. If they fail, it is reasonable to assume that the health of the user or other persons may be endangered.