

60-90 GHz SP3T Switch Flip Chip

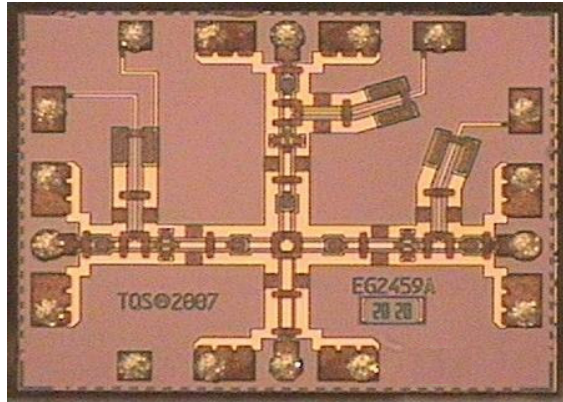

Measured Performance

Bias conditions OFF: Vd = 1.35 V, Id = ~10 mA, State 4
 ON: Vd = -5V, Id = 0 mA, State 2
 RF IN to RF OUT 2

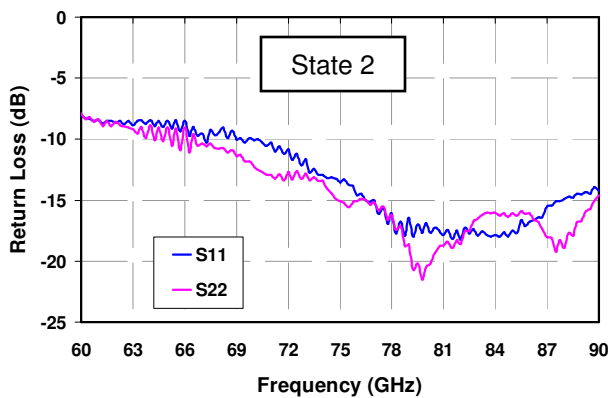
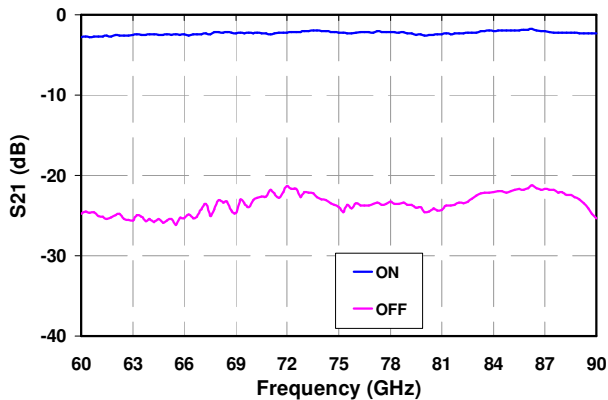

Key Features

- Frequency Range: 60-90 GHz
- 2.3 dB Typical Flipped Insertion Loss
- 20 dB Nominal Isolation
- > 13 dB Typical Thru State Return Loss
- < 5 nsec Switching Speed
- Integrated DC blocking at RF ports
- Chip dimensions: 1.69 x 1.37 x 0.38 mm
(0.067 x 0.054 x 0.015 in)

Primary Applications

- Automotive Transceivers
- E-Band Transceivers

Product Description

The TriQuint TGS4305-FC is a 60-90 GHz SP3T Switch. This part is designed using TriQuint's proven standard VPIN production process. The switching speed for TGS4305-FC is < 5 nsec typically.

The TGS4305-FC, when flipped, provides a nominal 2.3 dB insertion loss, > 13 dB Thru State return loss, and 20 dB isolation in the automotive band.

The TGS4305-FC integrates DC blocking capacitors on all output ports to reduce the number of off-chip components.

The TGS4305-FC has a protective surface passivation layer providing environmental robustness.

Lead-free and RoHS compliant

Table I
Absolute Maximum Ratings 1/

SYMBOL	PARAMETER	VALUES	NOTES
Vd1,2,3	Maximum Supply Voltage	-15 V to 2 V	
Id1,2,3	Maximum Supply Current	15 mA	
Pin	Maximum Input Power	27 dBm	
Tstg	Storage Temperature	-65 to 150 °C	

1/ These ratings represent the maximum operating values for this device.

Table II
Recommended Operating Conditions
Truth Table

State	RF IN to RF OUT 1	RF IN to RF OUT 2	RF IN To RF OUT 3	Vd1	Vd2	Vd3
1	ON	OFF	OFF	-5 V @ 0 mA	1.35 V @ 10 mA	1.35 V @ 10 mA
2	OFF	ON	OFF	1.35 V @ 10 mA	-5 V @ 0 mA	1.35 V @ 10 mA
3	OFF	OFF	ON	1.35 V @ 10 mA	1.35 V @ 10 mA	-5 V @ 0 mA
4	OFF	OFF	OFF	1.35 V @ 10 mA	1.35 V @ 10 mA	1.35 V @ 10 mA

Table III
RF Characterization Table

(TA = 25 °C, Nominal)
Probe Tip Calibration
Id = 6 mA, typical

PARAMETER	THROUGH PATH IDENTIFICATION	TEST CONDITIONS	MINIMUM	NOMINAL	MAXIMUM	UNITS
Insertion Loss (State 2)	RF Input to RF Output 1 RF Input to RF Output 2 RF Input to RF Output 3	F = 76 – 77 GHz		1.6	3.75	dB
Isolation On/off ratio (State 2 / 4)	RF Input to RF Output 1 RF Input to RF Output 2 RF Input to RF Output 3	F = 76 – 77 GHz	16	20		dB
Input Return Loss (State 2)	RF Input to RF Output 1 RF Input to RF Output 2 RF Input to RF Output 3	F = 76 – 77 GHz	8	10		dB
Output Return Loss (State 2)	RF Input to RF Output 1 RF Input to RF Output 2 RF Input to RF Output 3	F = 76 – 77 GHz	8	10		dB

Measured Data

**Insertion Loss
RF IN to RF OUT 2**

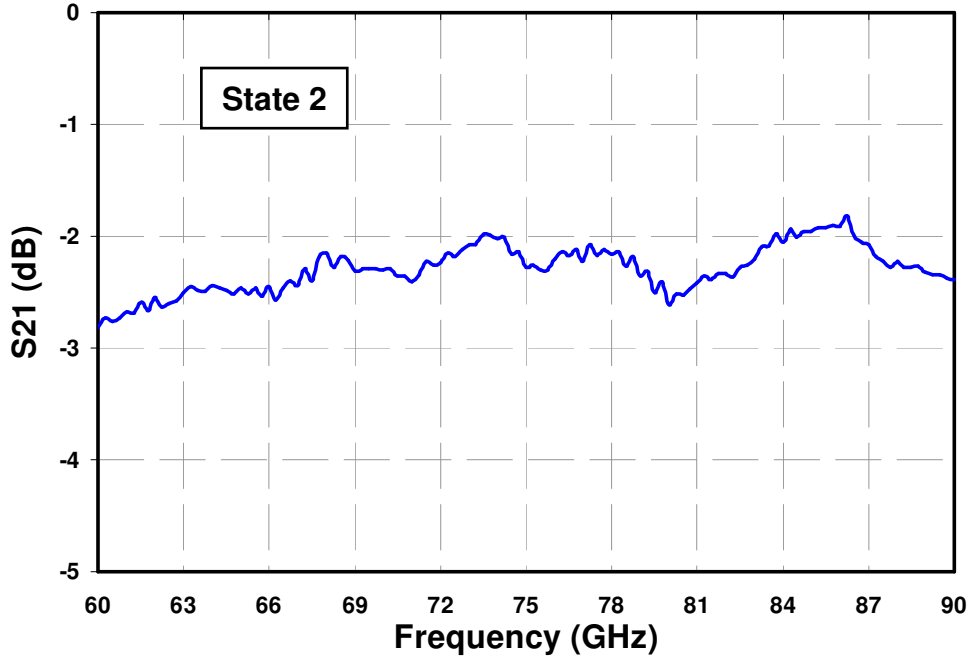

RF IN to RF OUT 2

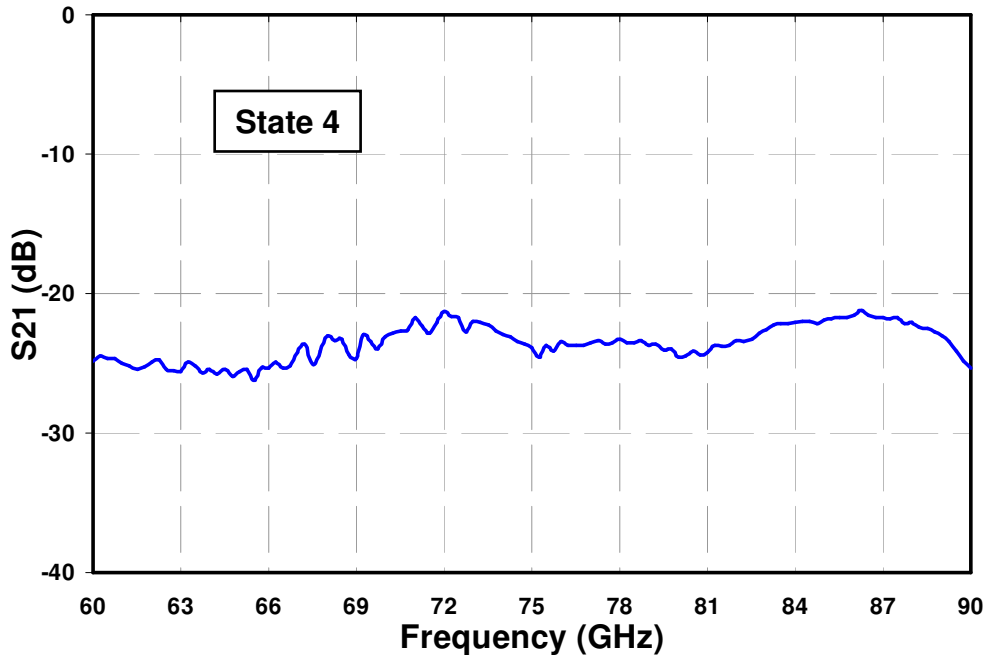

Measured Data

Return Loss
RF IN to RF OUT 2

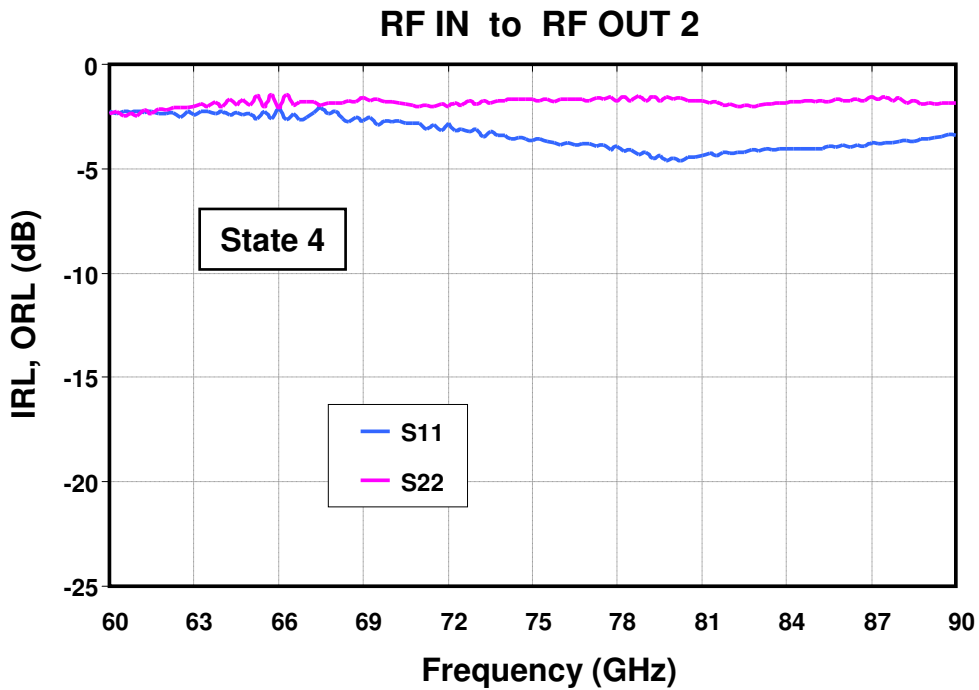
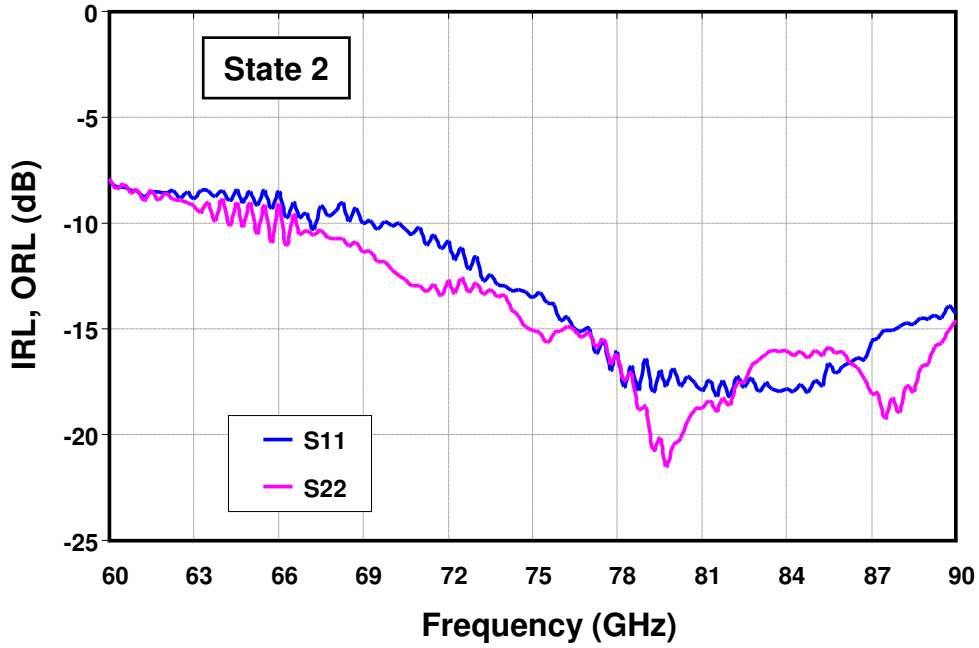

Measured Data

Insertion Loss
RF IN to RF OUT 3

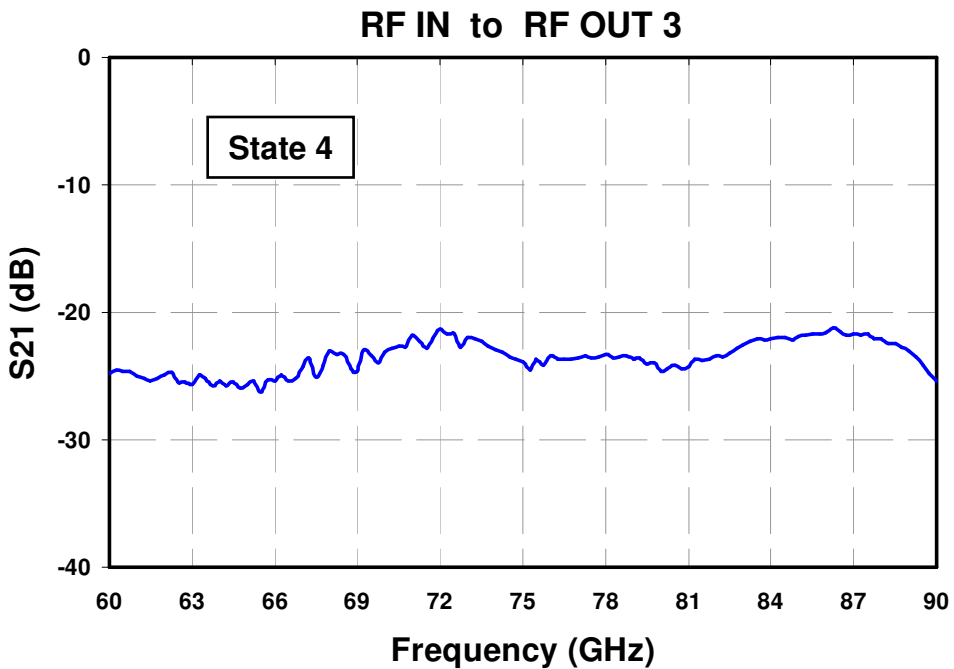
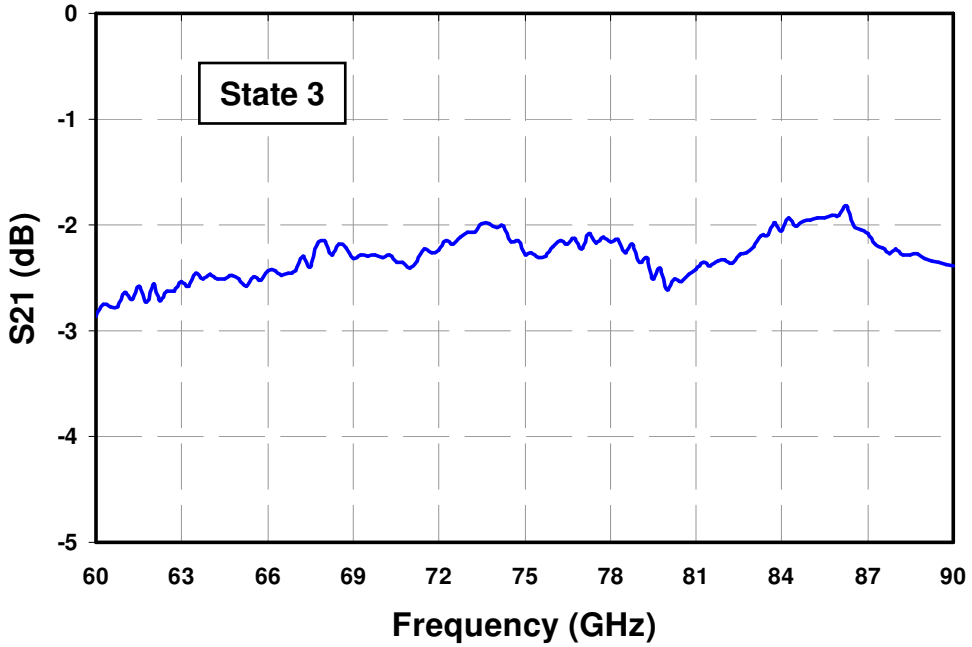

Measured Data

Return Loss

RF IN to RF OUT 3

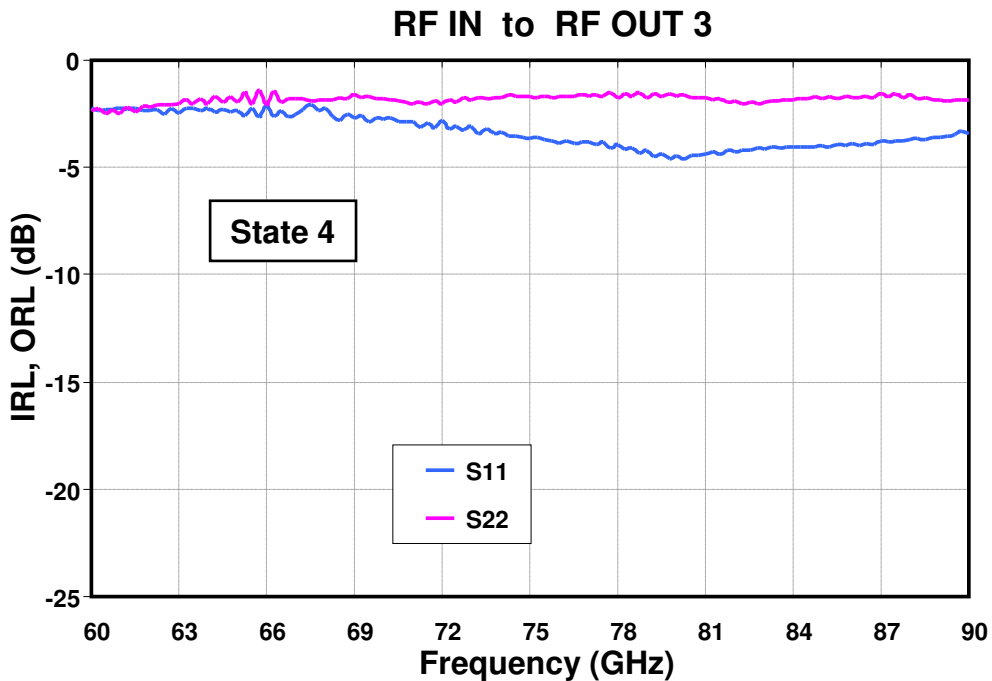
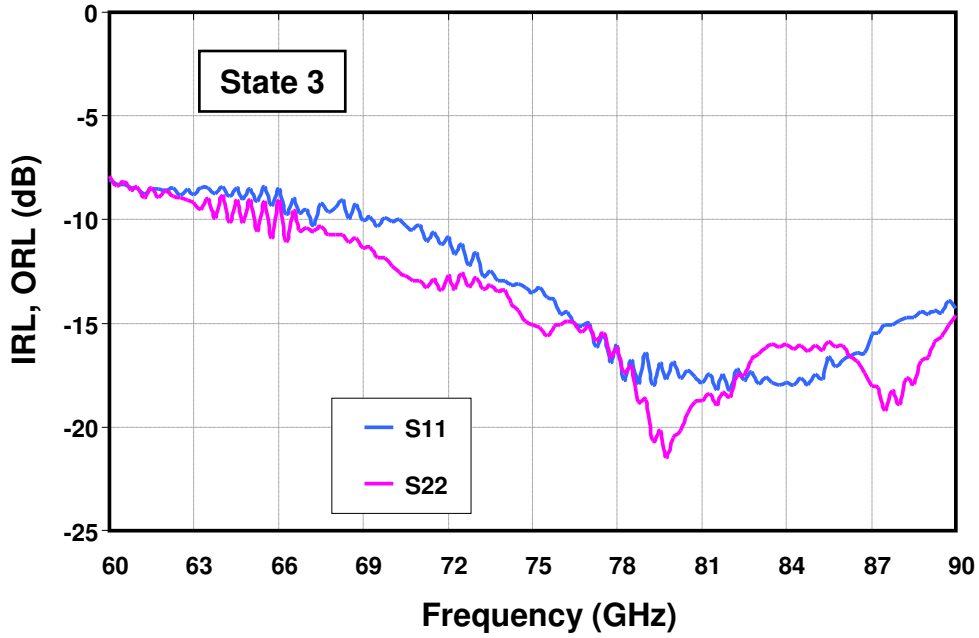

Electrical Schematic

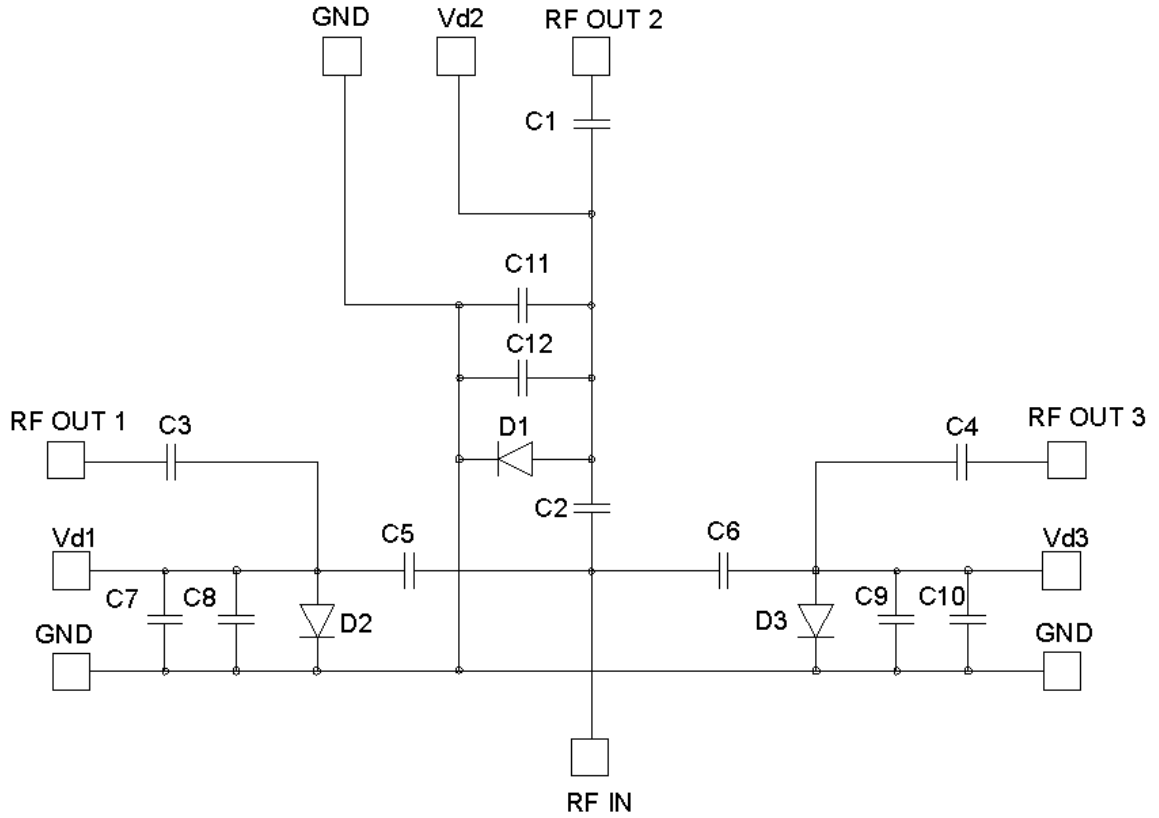

Mechanical Drawing
Drawing is for chip face up

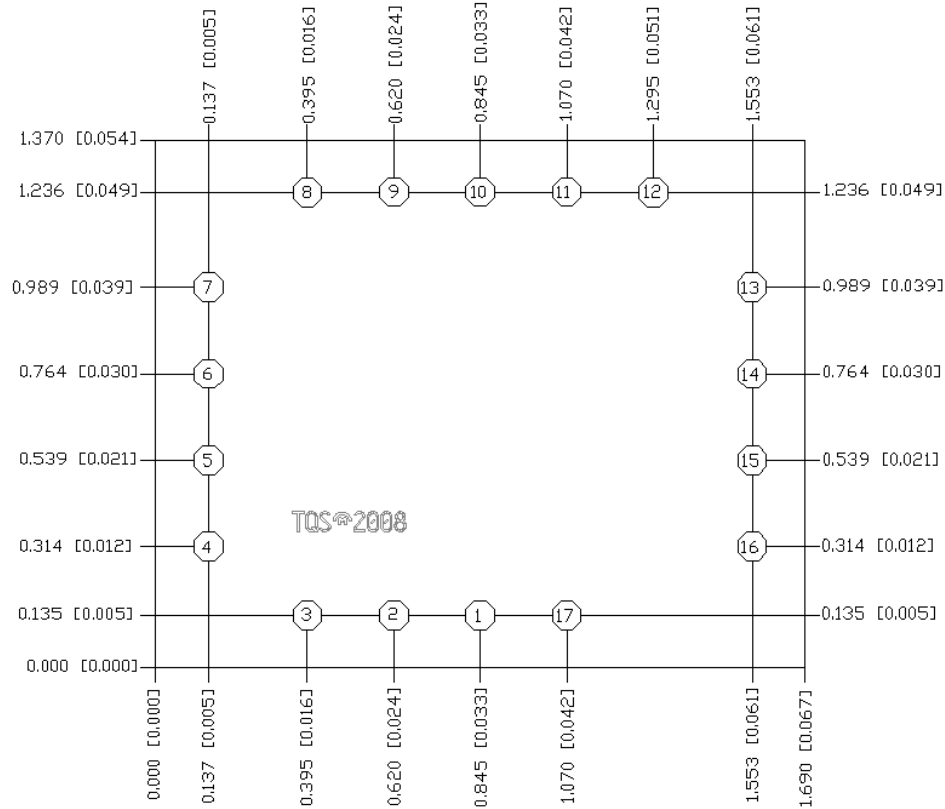

Units: millimeters (inches)

Thickness: 0.380 (0.015). Die x,y size tolerance: +/- 0.050 (0.002)

Chip edge to pillar dimensions are shown to center of pillar

Pillar # 1	RF IN	0.075 Φ
Pillar # 5	RF OUT 1	0.075 Φ
Pillar # 10	RF OUT 2	0.075 Φ
Pillar # 15	RF OUT 3	0.075 Φ
Pillar # 7	Vd1	0.075 Φ
Pillar # 12	Vd2	0.075 Φ
Pillar # 13	Vd3	0.075 Φ
Pillar # 8	DC Ground	0.075 Φ
Pillar # 2, 4, 6, 9, 11, 14, 16, 17	RF CPW Ground	0.075 Φ
Pillar # 3	Mechanical Support Only	0.075 Φ

GaAs MMIC devices are susceptible to damage from Electrostatic Discharge. Proper precautions should be observed during handling, assembly and test.

Recommended Assembly Diagram

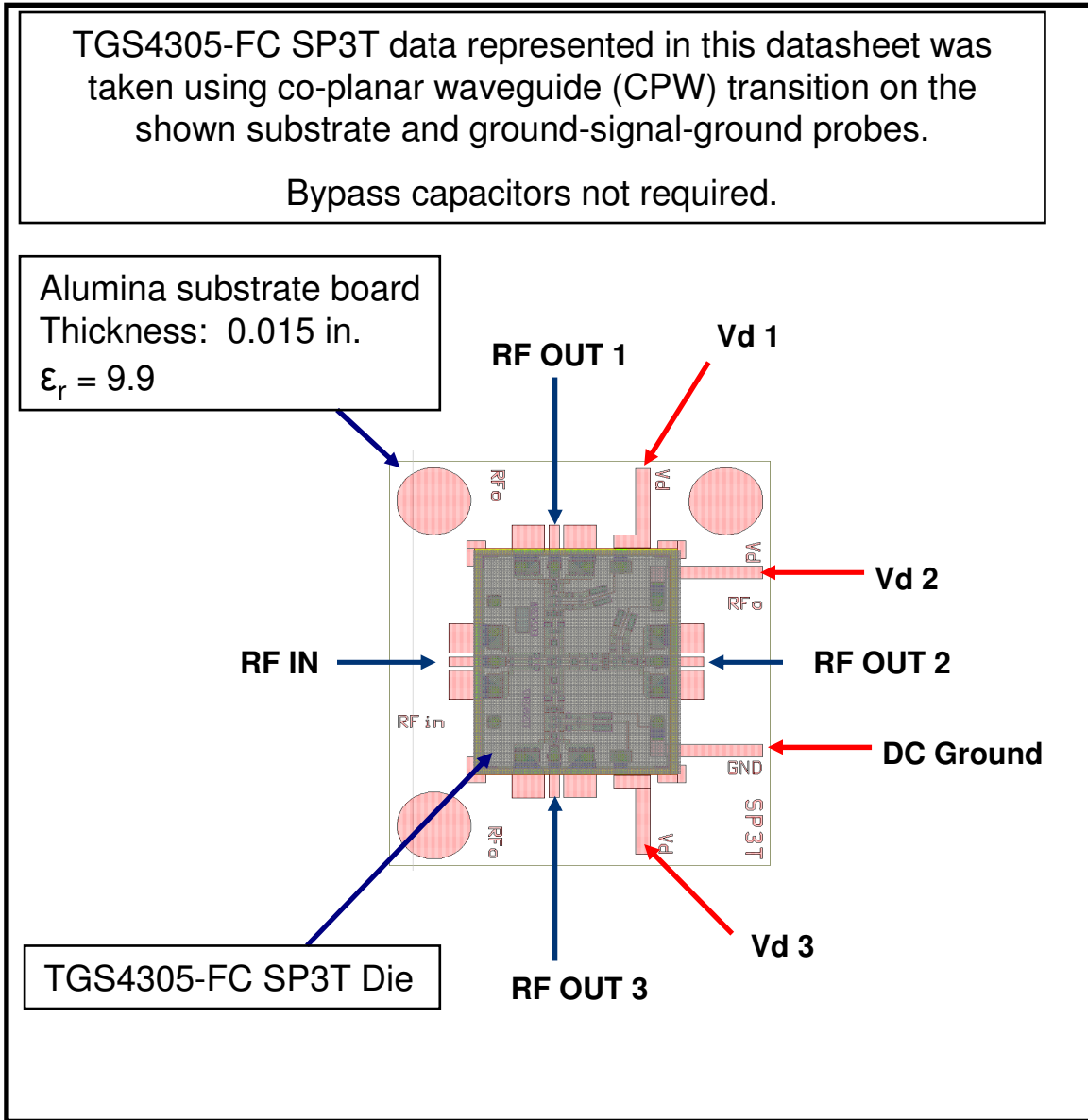

Die is flip-chip soldered to substrate

GaAs MMIC devices are susceptible to damage from Electrostatic Discharge. Proper precautions should be observed during handling, assembly and test.

Assembly Notes

Component placement and die attach assembly notes:

- Vacuum pencils and/or vacuum collets are the preferred method of pick up.
- Air bridges must be avoided during placement.
- Cu pillars on die are 65 um tall with a 22 um tall Sn solder cap.
- Recommended board metallization is evaporated TiW followed by nickel/gold at pillar attach interface. Ni is the adhesion layer for the solder and the gold keeps the Ni from oxidizing. The Au should be kept to a minimum to avoid embrittlement; suggested Au / Sn mass ratio must not exceed 8%.
- Au metallization is not recommended on traces due to solder wicking and consumption concerns. If Au traces are used, a physical solder barrier must be applied or designed into the pad area of the board. The barrier must be sufficient to keep the solder from undercutting the barrier.

Reflow process assembly notes:

- Minimum alloying temperatures 245 °C.
- Repeating reflow cycles is not recommended due to Sn consumption on the first reflow cycle.
- An alloy station or conveyor furnace with an inert atmosphere such as N2 should be used.
- Dip copper pillars in “no-clean flip chip” flux prior to solder attach. Suggest using a high temperature flux. Avoid exposing entire die to flux.
- If screen printing flux, use small apertures and minimize volume of flux applied.
- Coefficient of thermal expansion matching between the MMIC and the substrate/board is critical for long-term reliability.
- Devices must be stored in a dry nitrogen atmosphere.
- Suggested reflow will depend on board material and density.

See Triquint Application Note for flip-chip soldering process: TBD

Typical Reflow Profiles for TriQuint Cu / Sn Pillars

Process	Sn Reflow
Ramp-up Rate	3 °C/sec
Flux Activation Time and Temperature	60 – 120 sec @ 140 – 160 °C
Time above Melting Point (245 °C)	60 – 150 sec
Max Peak Temperature	300 °C
Time within 5 °C of Peak Temperature	10 – 20 sec
Ramp-down Rate	4 – 6 °C/sec

Ordering Information

Part	Package Style
TGA4305-FC	GaAs MMIC Die

GaAs MMIC devices are susceptible to damage from Electrostatic Discharge. Proper precautions should be observed during handling, assembly and test.