

### Dual IGBTMOD™ NF-Series Module 150 Amperes/1200 Volts

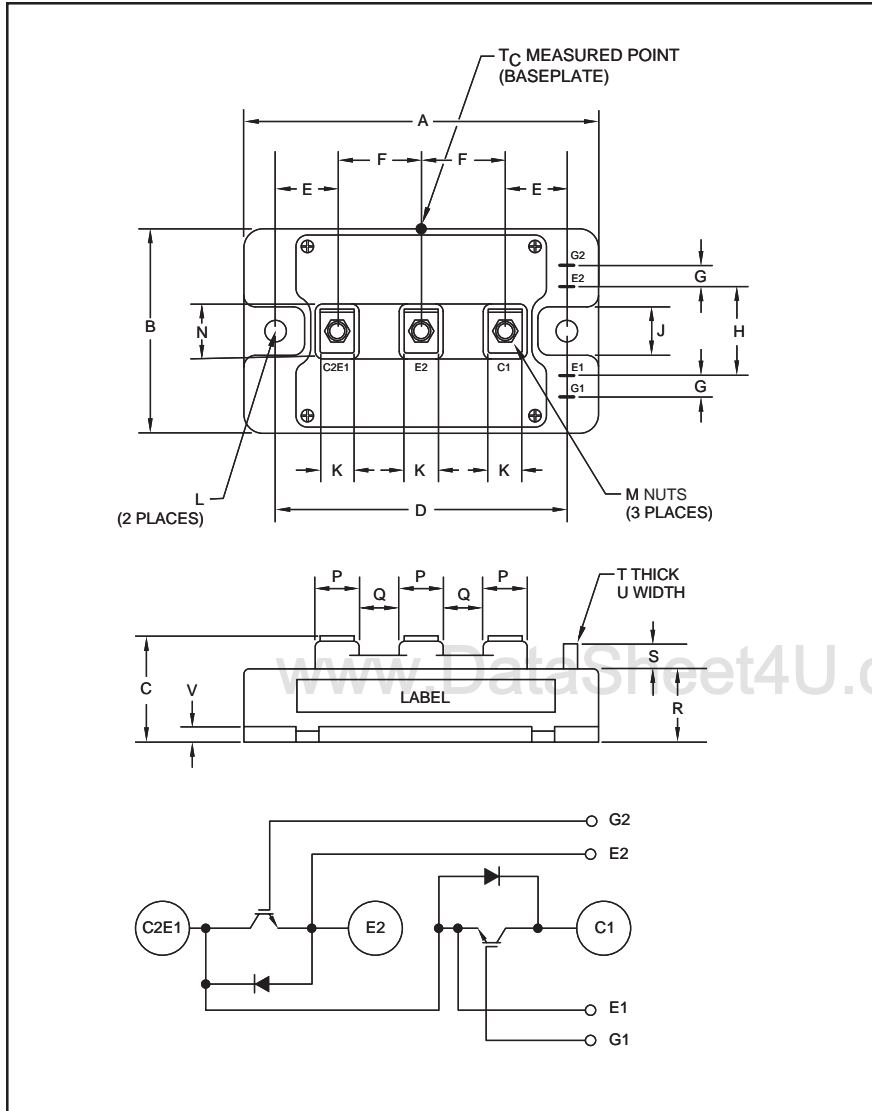

Outline Drawing and Circuit Diagram

Dimensions	Inches	Millimeters
A	3.70	94.0
B	1.89	48.0
C	1.14+0.004/-0.02	29.0+0.1/-0.5
D	3.15±0.01	80.0±0.25
E	0.67	17.0
F	0.91	23.0
G	0.16	4.0
H	0.71	18.0
J	0.51	13.0
K	0.47	12.0

Dimensions	Inches	Millimeters
L	0.26 Dia.	Dia. 6.5
M	M5 Metric	M5
N	0.79	20.0
P	0.63	16.0
Q	0.28	7.0
R	0.83	21.2
S	0.30	7.5
T	0.02	0.5
U	0.110	2.8
V	0.16	4.0



#### Description:

Powerex IGBTMOD™ Modules are designed for use in switching applications. Each module consists of two IGBT Transistors in a half-bridge configuration with each transistor having a reverse-connected super-fast recovery free-wheel diode. All components and interconnects are isolated from the heat sinking baseplate, offering simplified system assembly and thermal management.

#### Features:

- Low Drive Power
- Low  $V_{CE(sat)}$
- Discrete Super-Fast Recovery Free-Wheel Diode
- Isolated Baseplate for Easy Heat Sinking

#### Applications:

- AC Motor Control
- UPS
- Battery Powered Supplies

#### Ordering Information:

Example: Select the complete part module number you desire from the table below -i.e. CM150DY-24NF is a 1200V ( $V_{CES}$ ), 150 Ampere Dual IGBTMOD™ Power Module.

Type	Current Rating Amperes	$V_{CES}$ Volts (x 50)
CM	150	24



Powerex, Inc., 200 E. Hillis Street, Youngwood, Pennsylvania 15697-1800 (724) 925-7272

**CM150DY-24NF**  
**Dual IGBTMOD™ NF-Series Module**  
 150 Amperes/1200 Volts

### Absolute Maximum Ratings, $T_j = 25\text{ }^\circ\text{C}$ unless otherwise specified

Ratings	Symbol	CM150DY-24NF	Units
Junction Temperature	$T_j$	-40 to 150	$^\circ\text{C}$
Storage Temperature	$T_{\text{stg}}$	-40 to 125	$^\circ\text{C}$
Collector-Emitter Voltage (G-E Short)	$V_{\text{CES}}$	1200	Volts
Gate-Emitter Voltage (C-E Short)	$V_{\text{GES}}$	$\pm 20$	Volts
Collector Current*** (DC, $T_C = 110^\circ\text{C}$ )	$I_C$	150	Amperes
Peak Collector Current	$I_{\text{CM}}$	300*	Amperes
Emitter Current** ( $T_C = 25^\circ\text{C}$ )	$I_E$	150	Amperes
Peak Emitter Current**	$I_{\text{EM}}$	300*	Amperes
Maximum Collector Dissipation ( $T_C = 25^\circ\text{C}$ , $T_j \leq 150^\circ\text{C}$ )	$P_C$	780	Watts
Mounting Torque, M5 Main Terminal	—	30	in-lb
Mounting Torque, M6 Mounting	—	40	in-lb
Weight	—	310	Grams
Isolation Voltage (Main Terminal to Baseplate, AC 1 min.)	$V_{\text{ISO}}$	2500	Volts

### Static Electrical Characteristics, $T_j = 25\text{ }^\circ\text{C}$ unless otherwise specified

Characteristics	Symbol	Test Conditions	Min.	Typ.	Max.	Units
Collector-Cutoff Current	$I_{\text{CES}}$	$V_{\text{CE}} = V_{\text{CES}}$ , $V_{\text{GE}} = 0\text{V}$	—	—	1.0	mA
Gate Leakage Current	$I_{\text{GES}}$	$V_{\text{GE}} = V_{\text{GES}}$ , $V_{\text{CE}} = 0\text{V}$	—	—	0.5	$\mu\text{A}$
Gate-Emitter Threshold Voltage	$V_{\text{GE(th)}}$	$I_C = 15\text{mA}$ , $V_{\text{CE}} = 10\text{V}$	6.0	7.0	8.0	Volts
Collector-Emitter Saturation Voltage	$V_{\text{CE(sat)}}$	$I_C = 150\text{A}$ , $V_{\text{GE}} = 15\text{V}$ , $T_j = 25^\circ\text{C}$	—	1.8	2.5	Volts
		$I_C = 150\text{A}$ , $V_{\text{GE}} = 15\text{V}$ , $T_j = 125^\circ\text{C}$	—	2.0	—	Volts
Total Gate Charge	$Q_G$	$V_{\text{CC}} = 600\text{V}$ , $I_C = 150\text{A}$ , $V_{\text{GE}} = 15\text{V}$	—	1000	—	nC
Emitter-Collector Voltage**	$V_{\text{EC}}$	$I_E = 150\text{A}$ , $V_{\text{GE}} = 0\text{V}$	—	—	3.2	Volts

### Dynamic Electrical Characteristics, $T_j = 25\text{ }^\circ\text{C}$ unless otherwise specified

Characteristics	Symbol	Test Conditions	Min.	Typ.	Max.	Units
Input Capacitance	$C_{\text{ies}}$		—	—	35	nf
Output Capacitance	$C_{\text{oes}}$	$V_{\text{CE}} = 10\text{V}$ , $V_{\text{GE}} = 0\text{V}$	—	—	3	nf
Reverse Transfer Capacitance	$C_{\text{res}}$		—	—	0.68	nf
Inductive	Turn-on Delay Time	$V_{\text{CC}} = 600\text{V}$ , $I_C = 150\text{A}$ ,	—	—	120	ns
	Rise Time					
Load	Turn-off Delay Time	$V_{\text{GE}1} = V_{\text{GE}2} = 15\text{V}$ , $R_G = 2.1\Omega$ ,	—	—	450	ns
	Fall Time					
Switch		Inductive Load	—	—	350	ns
Diode Reverse Recovery Time**	$t_{\text{rr}}$	Switching Operation,	—	—	150	ns
Diode Reverse Recovery Charge**	$Q_{\text{rr}}$	$I_E = 150\text{A}$	—	7.5	—	$\mu\text{C}$

\*Pulse width and repetition rate should be such that device junction temperature ( $T_j$ ) does not exceed  $T_{j(\text{max})}$  rating.

\*\*Represents characteristics of the anti-parallel, emitter-to-collector free-wheel diode (FWDi)

\*\*\*  $T_C$  measured point is just under the chips. If this value is used,  $R_{\text{th(f-a)}}$  should be measured just under the chips



Powerex, Inc., 200 E. Hillis Street, Youngwood, Pennsylvania 15697-1800 (724) 925-7272

### CM150DY-24NF

#### Dual IGBTMOD™ NF-Series Module

150 Amperes/1200 Volts

### Thermal and Mechanical Characteristics, $T_j = 25^\circ\text{C}$ unless otherwise specified

Characteristics	Symbol	Test Conditions	Min.	Typ.	Max.	Units
Thermal Resistance, Junction to Case	$R_{th(j-c)Q}$	Per IGBT 1/2 Module, $T_C$ Reference Point per Outline Drawing	—	—	0.16	$^\circ\text{C}/\text{W}$
Thermal Resistance, Junction to Case	$R_{th(j-c)D}$	Per FWDi 1/2 Module, $T_C$ Reference Point per Outline Drawing	—	—	0.25	$^\circ\text{C}/\text{W}$
Thermal Resistance, Junction to Case	$R_{th(j-c)'Q}$	Per IGBT 1/2 Module, $T_C$ Reference Point Under Chips	—	—	0.093	$^\circ\text{C}/\text{W}$
Contact Thermal Resistance	$R_{th(c-f)}$	Per 1/2 Module, Thermal Grease Applied	—	0.07	—	$^\circ\text{C}/\text{W}$
External Gate Resistance	$R_G$		2.1	—	21	$\Omega$

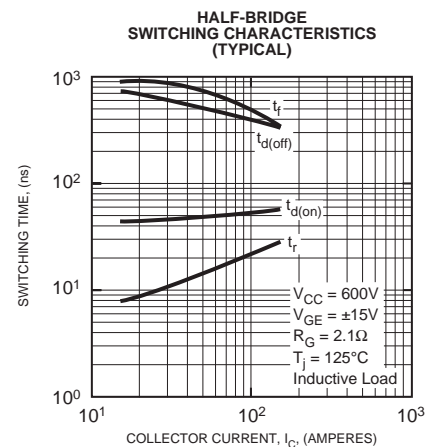
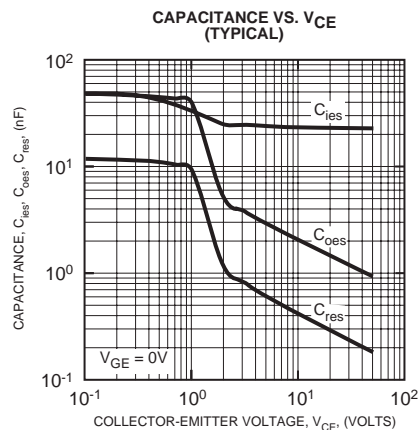
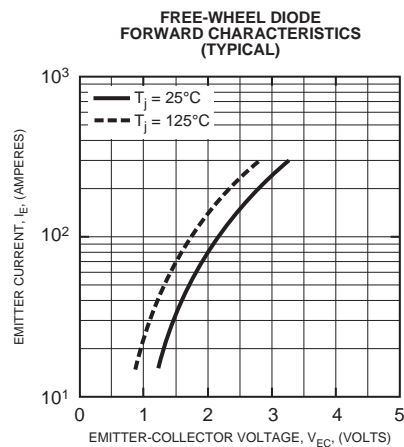
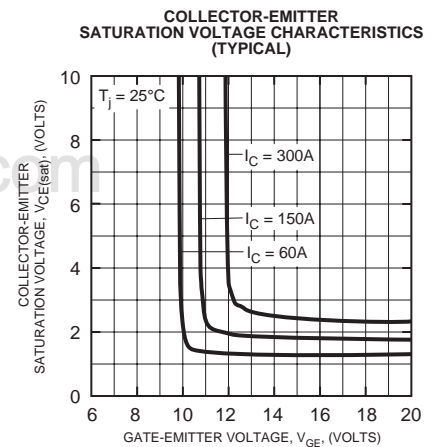
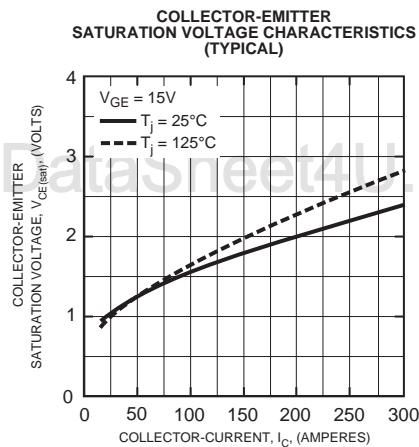
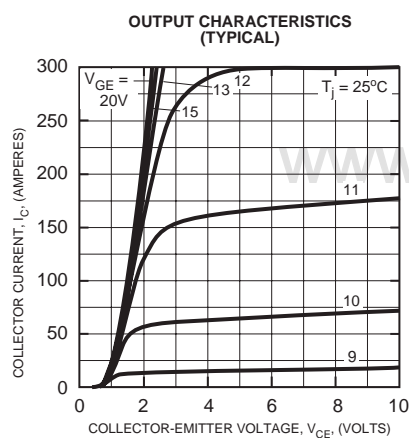



Powerex, Inc., 200 E. Hillis Street, Youngwood, Pennsylvania 15697-1800 (724) 925-7272

**CM150DY-24NF**  
**Dual IGBTMOD™ NF-Series Module**  
 150 Amperes/1200 Volts

