



LIGITEK

LIGITEK ELECTRONICS CO.,LTD.
Property of Ligitek Only

FOUR DIGIT LED DISPLAY (0.3 Inch)

LFD3A5/64/R1-XX

DATA SHEET

DOC. NO : QW0905-LFD3A5/64/R1-XX

REV. : A

DATE : 23 - Nov. - 2005



Package Dimensions

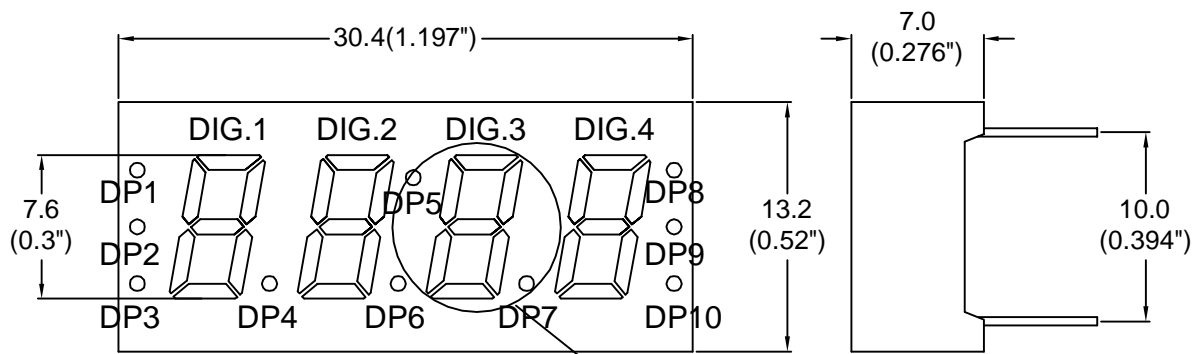

LFD3A5/64/R1-XX
LIGITEK

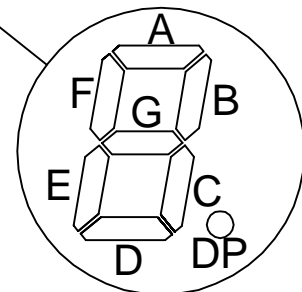
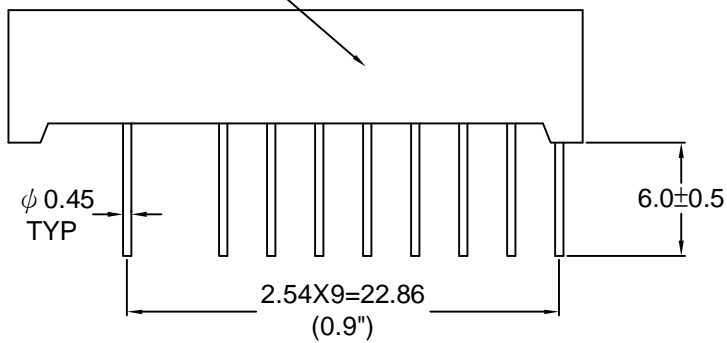

Note : 1.All dimension are in millimeters and (Inch) tolerance is ± 0.25 mm unless otherwise noted.
2.Specifications are subject to change without notice.



Internal Circuit Diagram

LFD3A54/R1-XX

LFD3A64/R1-XX

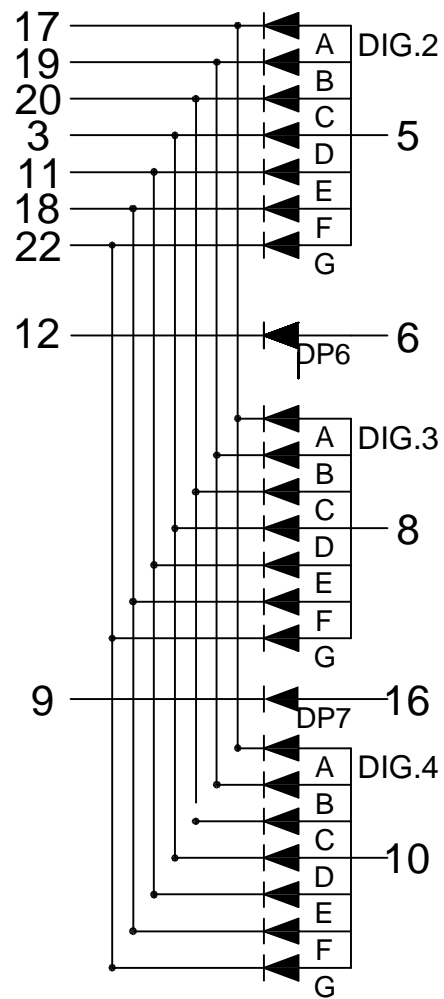
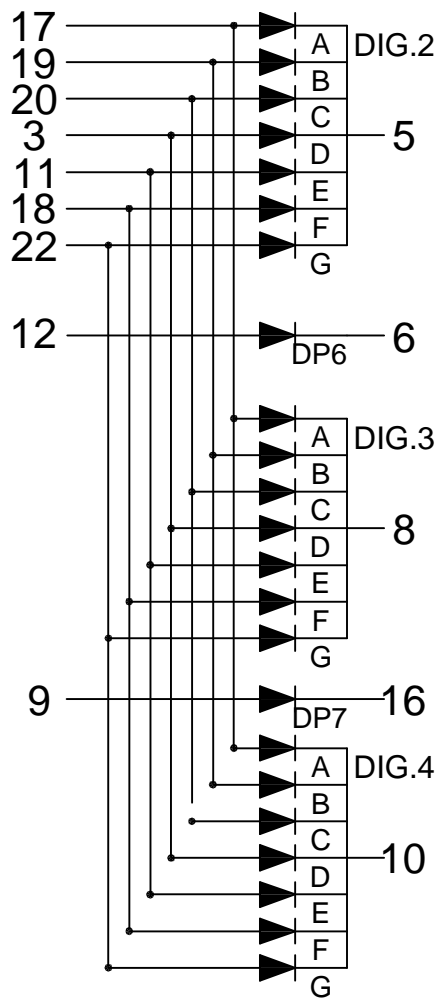

1,2,4,7,13,14,15,21,23,24 NOPIN

**Electrical Connection**

PIN NO.	LFD3A54/R1-XX	PIN NO.	LFD3A64/R1-XX
1	NO PIN	1	NO PIN
2	NO PIN	2	NO PIN
3	Anode D	3	Cathode D
4	NO PIN	4	NO PIN
5	Commom Cathode Dig.2	5	Commom Anode Dig2
6	Cathode DP5,DP6	6	Anode DP5
7	NO PIN	7	NO PIN
8	Common Cathode Dig.3	8	Common Anode Dig.3
9	Anode DP7	9	Cathode DP7
10	Common Cathode Dig.4	10	Common Anode Dig.4
11	Anode (Dig.2,Dig.3,Dig.4) E	11	Cathode (Dig.2,Dig.3,Dig.4) E
12	Anode DP6	12	Cathode DP6
13	NO PIN	13	NO PIN
14	NO PIN	14	NO PIN
15	NO PIN	15	NO PIN
16	Cathode DP7	16	Cathode DP7
17	Anode A	17	Cathode A
18	Anode F	18	Cathode F
19	Anode B	19	Cathode B
20	Anode C	20	Cathode C
21	NO PIN	21	NO PIN
22	Anode G	22	Cathode G
23	NO PIN	23	NO PIN
24	NO PIN	24	NO PIN



Absolute Maximum Ratings at Ta=25 °C

Parameter	Symbol	Ratings	UNIT
		E	
Forward Current Per Chip	IF	30	mA
Peak Forward Current Per Chip (Duty 1/10,0.1ms Pulse Width)	IFP	120	mA
Power Dissipation Per Chip	PD	100	mW
Reverse Current Per Any Chip	Ir	10	μA
Operating Temperature	Topr	-25 ~ +85	°C
Storage Temperature	Tstg	-25 ~ +85	°C
Solder Temperature 1/16 Inch Below Seating Plane For 3 Seconds At 260 °C			

Part Selection And Application Information(Ratings at 25°C)

PART NO	CHIP		Common Cathode or Anode	λ P (nm)	Δ λ (nm)	Electrical					IV-M
	Material	Emitted				Vf(v)			Iv(mcd)		
						Min.	Typ.	Max.	Min.	Typ.	
LFD3A54/R1-XX	GaAsP/GaP	Orange	Common Cathode	635	45	1.7	2.1	2.6	0.5	1.0	2:1
LFD3A64/R1-XX			Common Anode								

Note : 1. The forward voltage data did not including ±0.1V testing tolerance.
2. The luminous intensity data did not including ±15% testing tolerance.

**Test Condition For Each Parameter**

Parameter	Symbol	Unit	Test Condition
Forward Voltage Per Chip	V _f	volt	I _f =20mA
Luminous Intensity Per Chip	I _v	mcd	I _f =10mA
Peak Wavelength	λ _p	nm	I _f =20mA
Spectral Line Half-Width	Δλ	nm	I _f =20mA
Reverse Current Any Chip	I _r	μA	V _r =5V
Luminous Intensity Matching Ratio	IV-M		



Typical Electro-Optical Characteristics Curve

E CHIP

Fig.1 Forward current vs. Forward Voltage

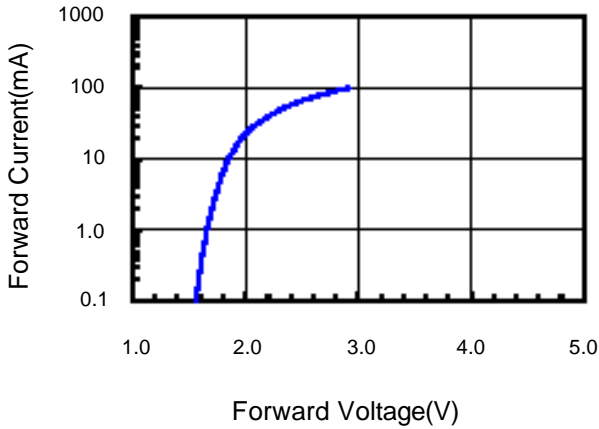

Fig.2 Relative Intensity vs. Forward Current

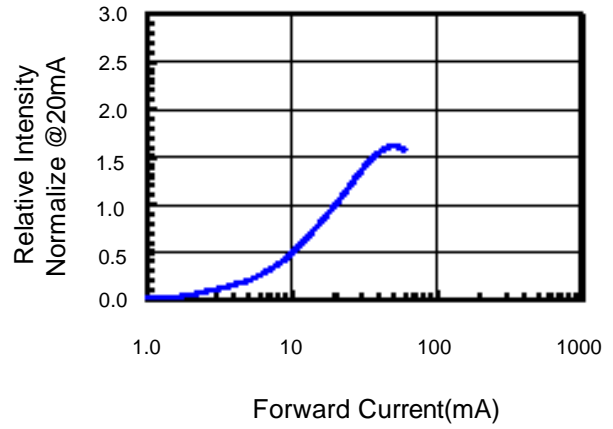

Fig.3 Forward Voltage vs. Temperature

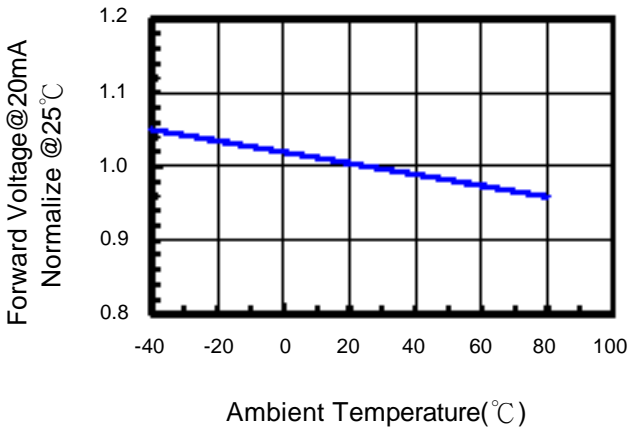

Fig.4 Relative Intensity vs. Temperature

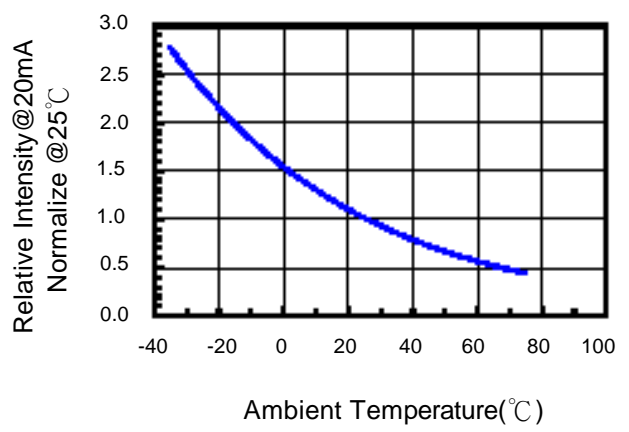
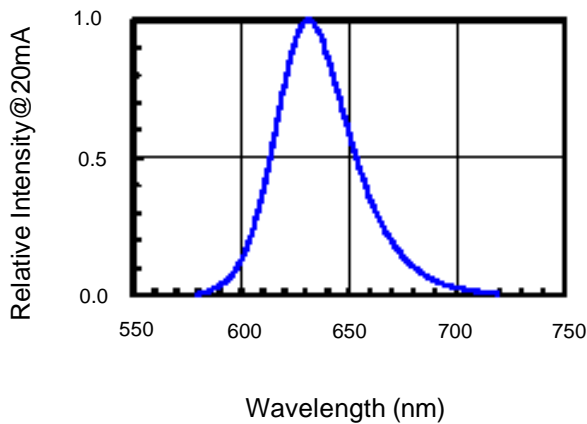

Fig.5 Relative Intensity vs. Wavelength



**Reliability Test:**

Test Item	Test Condition	Description	Reference Standard
Operating Life Test	1.Under Room Temperature 2.If=10mA 3.t=1000 hrs (-24hrs, +72hrs)	This test is conducted for the purpose of determining the resistance of a part in electrical and thermal stressed.	MIL-STD-750: 1026 MIL-STD-883: 1005 JIS C 7021: B-1
High Temperature Storage Test	1.Ta=105 °C±5°C 2.t=1000 hrs (-24hrs, +72hrs)	The purpose of this is the resistance of the device which is laid under condition of high temperature for hours.	MIL-STD-883:1008 JIS C 7021: B-10
Low Temperature Storage Test	1.Ta=-40 °C±5°C 2.t=1000 hrs (-24hrs, +72hrs)	The purpose of this is the resistance of the device which is laid under condition of low temperature for hours.	JIS C 7021: B-12
High Temperature High Humidity Test	1.Ta=65 °C±5°C 2.RH=90 %~95% 3.t=240hrs ±2hrs	The purpose of this test is the resistance of the device under tropical for hours.	MIL-STD-202:103B JIS C 7021: B-11
Thermal Shock Test	1.Ta=105 °C±5°C & -40 °C±5°C (10min) (10min) 2.total 10 cycles	The purpose of this is the resistance of the device to sudden extreme changes in high and low temperature.	MIL-STD-202: 107D MIL-STD-750: 1051 MIL-STD-883: 1011
Solder Resistance Test	1.T.Sol=260 °C±5°C 2.Dwell time= 10 ±1sec.	This test intended to determine the thermal characteristic resistance of the device to sudden exposures at extreme changes in temperature when soldering the lead wire.	MIL-STD-202: 210A MIL-STD-750: 2031 JIS C 7021: A-1
Solderability Test	1.T.Sol=230 °C±5°C 2.Dwell time=5 ±1sec	This test intended to see soldering well performed or not.	MIL-STD-202: 208D MIL-STD-750: 2026 MIL-STD-883: 2003 JIS C 7021: A-2