

## **OEM Accelerometer Piezoresistive Low Cost**

### Features

- Full Calibration Data Supplied
- Serialized
- DC Response
- Wide Bandwidth
- High Sensitivity
- Built-In Damping
- Miniature Size
- Low Mass
- Built-In Overrange Stops
- Solid State Reliability
- Ease of Mounting

### Typical Applications

- Automotive Suspension Control
- Automotive Braking Control
- Machine Tool Monitoring
- Industrial Vibration Monitoring
- Computer Peripherals
- Modal Analysis
- Security Systems Motion Detection
- Aerospace Flight Navigation
- Robotic Motion Control
- Appliance Control
- Medical Patient Activity Monitoring
- Military Arming and Fuzing

### Standard Ranges

- ± 2g
- ± 5g
- ± 10g
- ± 20g
- ± 50g
- ± 100g
- ± 200g
- ± 500g

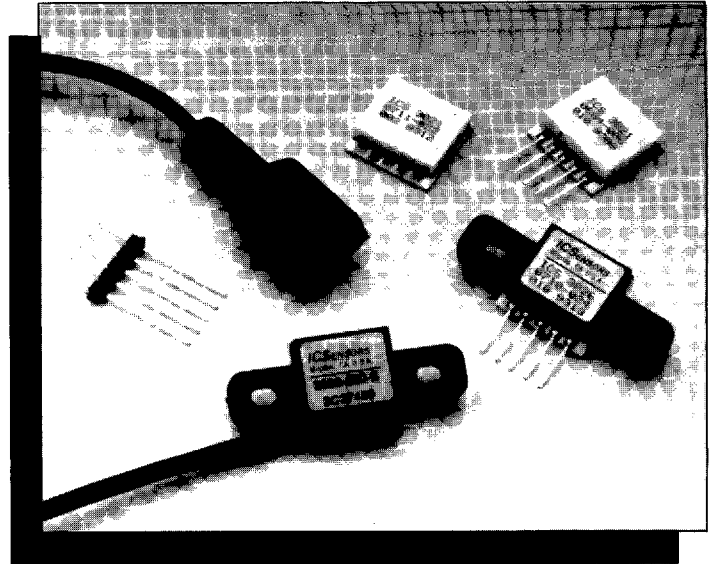

### Description

The Models 3021 and 3026 are general purpose, solid-state piezoresistive accelerometers packaged on a ceramic substrate. The Model 3026 includes a bracket for easy mechanical mounting. Both models are intended for use where small size, excellent performance, and low cost are required.

The accelerometer consists of a micromachined silicon mass suspended by multiple beams from a silicon frame. Piezoresistors located in the beams change their resistance as the motion of the suspended mass changes the strain in the beams. Silicon caps on the top and the bottom of the device are added to provide over-range stops and unusually high shock resistance and durability. As a result of this unique three-layer silicon structure, these accelerometers have a very low profile and low mass and are batch fabricated at a very low cost. An added result of this structure is built-in damping, which allows a wider useable bandwidth to be achieved.

A detailed calibration sheet that provides the measured test and calibration data for the sensor is included with each unit. A sample of this calibration sheet is on the back of this data sheet as Figure 2. In addition to the test data, the values of calibration and temperature compensation resistors are also included.

The devices are available in standard acceleration ranges from  $\pm 2g$  to  $\pm 500g$ . Each sensor is individually serialized. Device performance characteristics and packaging can be easily tailored on a special order basis to meet the requirements of specific applications.

# Models 3021 and 3026

## Signal Conditioning

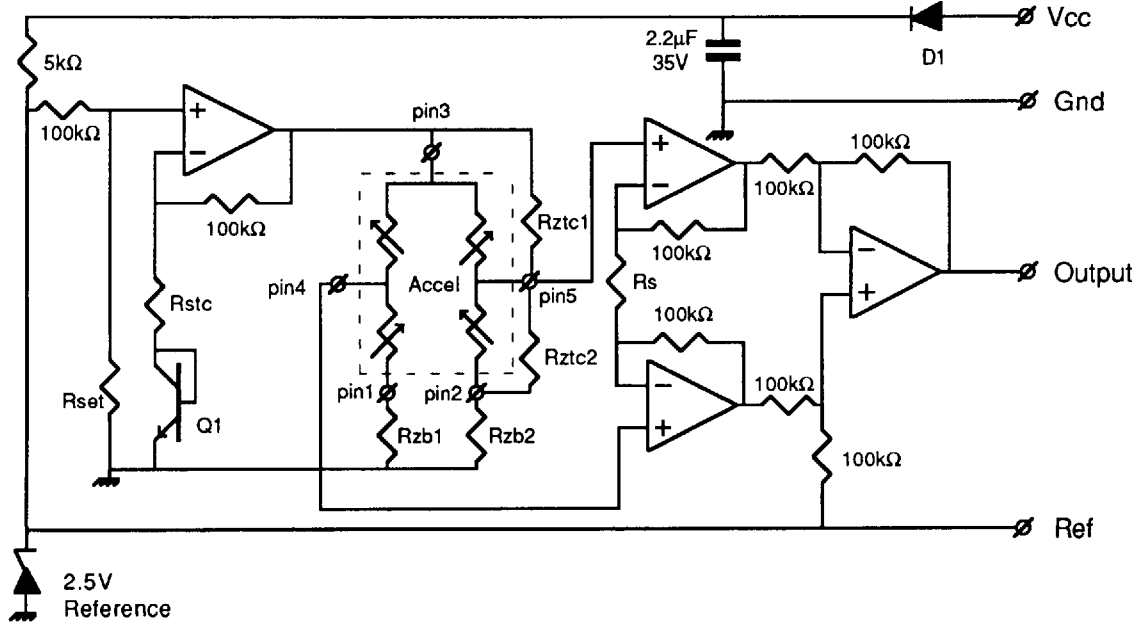
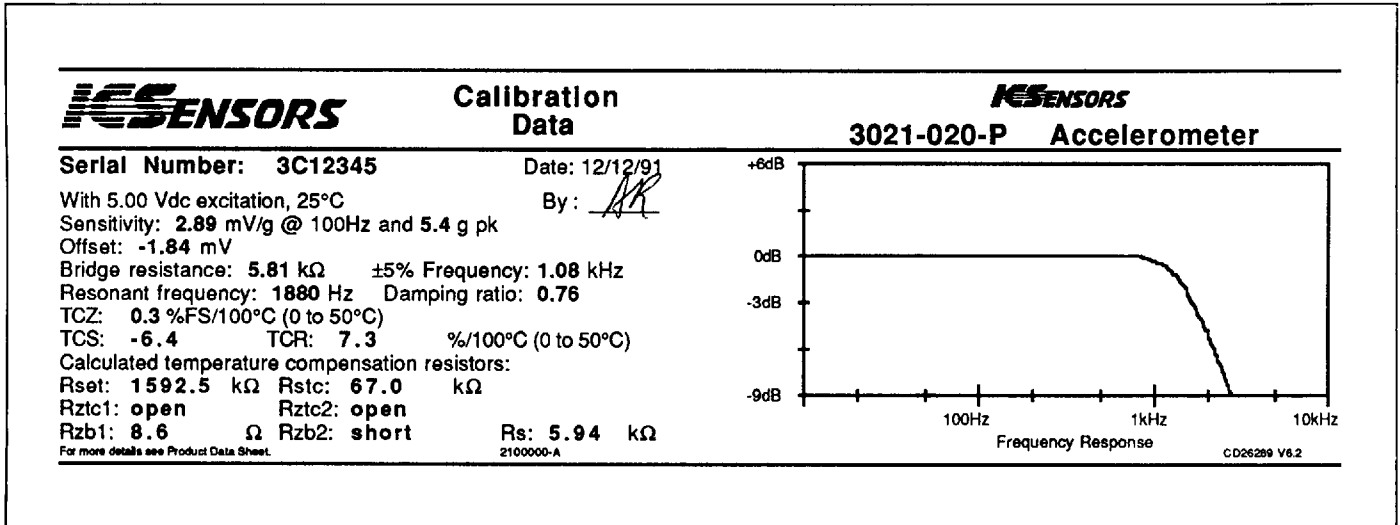

**Figure 1. Typical Temperature Compensation and Amplification Circuit (component values specified for each sensor)**

Q1: 2N3904  
 D1: 1N914 or equivalent.  
 Op Amps: LT1014, LM324 or equivalent.

- Rstc sets the excitation voltage ramp to compensate the sensitivity error due to temperature.
- Rset sets the excitation voltage to 5V at 25°C.
- Rzb1, Rzb2 and Rztc1 and Rztc2 calibrate the zero offset and compensate the offset error due to temperature.
- Rs calibrates the output span.
- Vcc must be ≥ 8 VDC.

## Calibration Data



**Figure 2. Calibration Data Sheet**

A calibration data sheet similar to the sample shown above is included with each unit. The calibration sheet provides the measured test and calibration data for the sensor. In addition to the test data, the values of calibration and temperature compensation resistors are also included.

## Performance Specifications

Supply = 5 Volts & Ambient Temperature = 25°C (Unless otherwise specified)

PARAMETER	RANGE			
	±2g	±5g	±10g	±20g
Frequency Response (MIN) (See Notes 9 and 11)	0-250 Hz	0-300 Hz	0-400 Hz	0-600 Hz
Mounted Resonant Frequency (MIN) (See Note 9)	700 Hz	800 Hz	1000 Hz	1500 Hz
Sensitivity (MIN/MAX) (See Note 9)	8.0/20.0 mV/g	6.0/15.0 mV/g	3.0/6.0 mV/g	1.5/3.0 mV/g

PARAMETER	RANGE			
	±50g	±100g	±200g	±500g
Frequency Response (MIN) (See Notes 9 and 11)	0-1000 Hz	0-1500 Hz	0-2000 Hz	0-2400 Hz
Mounted Resonant Frequency (MIN) (See Note 9, 12)	2000 Hz	3000 Hz	4000 Hz	5000 Hz
Sensitivity (MIN/MAX) (See Note 9)	0.6/1.5 mV/g	0.3/0.6 mV/g	0.15/0.3 mV/g	0.06/0.15 mV/g

PARAMETER	ALL RANGES				
	MIN	TYP	MAX	UNITS	NOTES
Zero Acceleration Output		5	25	±mV	9
Damping Ratio	0.4	0.7	0.9		3,9,12
Linearity		0.2	1	±%FS	4,9
Transverse Sensitivity		1	3	±%FS	
Input & Output Resistance	2.5	3.5	6.5	kΩ	9
Temperature Coefficient - Sensitivity		1.0	2.0	±%FS	2,5,9
Temperature Coefficient - Zero		1.0	2.0	±%FS	2,5,9
Supply Voltage		5.0	10.0	VDC	
Output Noise		1.0		μVp-p	10
Output Load Resistance	2			MΩ	6
Acceleration Limits (Any Direction)		20X		Rated	8
Operating Temperature	-40°C to +125°C				
Storage Temperature	-55°C to +150°C				
Weight (Excluding Cable/Pins)	1.4 Grams				
Materials (3021 Package)	Alumina ceramic substrate with alumina ceramic cap				
Materials (3026 Package)	Alumina ceramic substrate with high impact Ultem™ plastic cap				
Mounting/Torque (3026 Only)	Two slotted holes for 4-40 screws / 6 in - lbs. torque				

## Notes

- Positive voltage change for positive acceleration; negative voltage change for negative acceleration.
- Percentage values are with external compensation. The uncompensated temperature coefficients are measured and specified for each unit. In addition, the values of the resistors that provide a temperature compensated output are provided with each unit. These resistors are for use in the circuit shown in Figure 1.
- Damping factor is controlled to within ±10% over operating temperature range. Alternate damping ratios are available on a special order basis.
- Best Fit Straight Line linearity. For full scale ranges of 10g or less, the maximum non-linearity is ± 2%.
- Temperature range: 0-50°C in reference to 25°C.
- Prevents increase of TC-Sensitivity and decrease of sensitivity due to output loading.
- Various electrical connections are available: P = pins, S = shielded cable, N = none.
- 400g for ± 2g, ± 5 g, and ± 10g versions. 20X or 2000g, whichever is lower, for other versions.
- Actual test data for this parameter is included on the calibration sheet included with each sensor. A sample of this calibration sheet is on the back of this data sheet as Figure 2.
- 10Hz to 1kHz.
- The useful frequency range is defined as the range of frequencies over which the device sensitivity is within ±5% of the DC value.
- For sensors having resonant frequency greater than 5 kHz, the calibration data sheet will indicate "> 5 kHz." In addition, the damping ratio will indicate N/A.

Connections/Dimensions

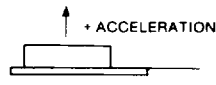
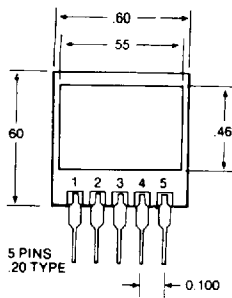

3021-XXX-P

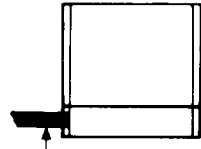

0.11 DIA  
12" SHIELDED CABLE  
(FEMALE CONNECTOR TERMINALS  
WITH 0.10 SPACING)



3021-XXX-S

ALL DIMENSIONS ARE IN INCHES

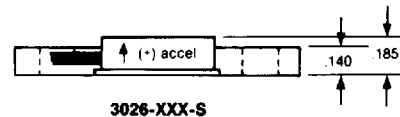
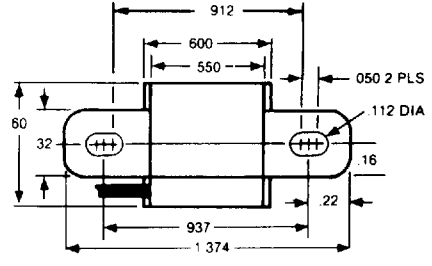

3026-XXX-S

ACCELEROMETER EQUIVALENT CIRCUIT

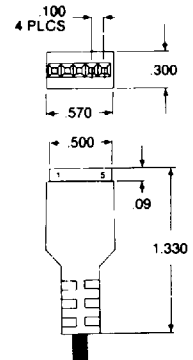
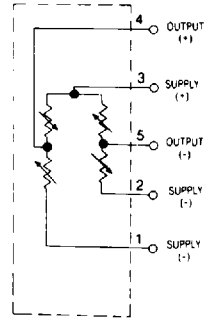

ALL SHIELDED CABLE VERSIONS  
COME WITH THE ABOVE CONNECTOR  
(MATING CONNECTOR PROVIDED)

Ordering Information

3026 - 050 - S

- Electrical Connection (P,N,S — see Note 7)
- Acceleration Range
- Model

Represented By

IC Sensors products are warranted against defects in material and workmanship for 12 months from date of shipment. Products not subjected to misuse will be repaired or replaced. THE FOREGOING IS IN LIEU OF ALL OTHER EXPRESSED OR IMPLIED WARRANTIES. IC Sensors reserves the right to make changes to any product herein and assumes no liability arising out of the application or use of any product or circuit described or referenced herein.



1701 McCarthy Blvd. Milpitas, California 95035-7416 Fax (408) 432-7322 Phone (408) 432-1800

4