



# STPS10L45CT/CG/CF/CFP

## LOW DROP POWER SCHOTTKY RECTIFIER

### MAIN PRODUCTS CHARACTERISTICS

<b>I<sub>F(AV)</sub></b>	<b>2x5 A</b>
<b>V<sub>RRM</sub></b>	<b>45 V</b>
<b>T<sub>j</sub> (max)</b>	<b>150°C</b>
<b>V<sub>F</sub> (max)</b>	<b>0.46 V</b>

### FEATURES AND BENEFITS

- LOW FORWARD VOLTAGE DROP MEANING VERY SMALL CONDUCTION LOSSES
- LOW SWITCHING LOSSES ALLOWING HIGH FREQUENCY OPERATION
- INSULATED PACKAGE: ISOWATT220AB, TO-220FPAB  
Insulating voltage = 2000V DC  
Capacitance = 12pF
- AVALANCHE CAPABILITY SPECIFIED

### DESCRIPTION

Dual center tap Schottky rectifiers suited for Switched Mode Power Supplies and high frequency DC to DC converters.

Packaged in TO-220AB, ISOWATT220AB, TO-220FPAB and D<sup>2</sup>PAK, these devices are intended for use in low voltage, high frequency inverters, free-wheeling and polarity protection applications.

### ABSOLUTE RATINGS (limiting values, per diode)

Symbol	Parameter			Value	Unit	
V <sub>RRM</sub>	Repetitive peak reverse voltage			45	V	
I <sub>F(RMS)</sub>	RMS forward current			20	A	
I <sub>F(AV)</sub>	Average forward current	TO-220AB D <sup>2</sup> PAK	T <sub>c</sub> = 135°C δ = 0.5	Per diode Per device	5 10	A
		ISOWATT220AB TO-220FPAB	T <sub>c</sub> = 115°C δ = 0.5	Per diode Per device	5 10	A
I <sub>FSM</sub>	Surge non repetitive forward current		tp = 10 ms	Sinusoidal	150	A
I <sub>RRM</sub>	Repetitive peak reverse current		tp = 2 μs	square F=1kHz	1	A
I <sub>RSM</sub>	Non repetitive peak reverse current		tp = 100 μs	square	2	A
P <sub>ARM</sub>	Repetitive peak avalanche power		tp = 1 μs	T <sub>j</sub> = 25°C	2700	W
T <sub>stg</sub>	Storage temperature range			- 65 to + 150	°C	
T <sub>j</sub>	Maximum operating junction temperature *			150	°C	
dV/dt	Critical rate of rise of reverse voltage			10000	V/μs	

\* :  $\frac{dP_{tot}}{dT_j} < \frac{1}{R_{th}(j-a)}$  thermal runaway condition for a diode on its own heatsink

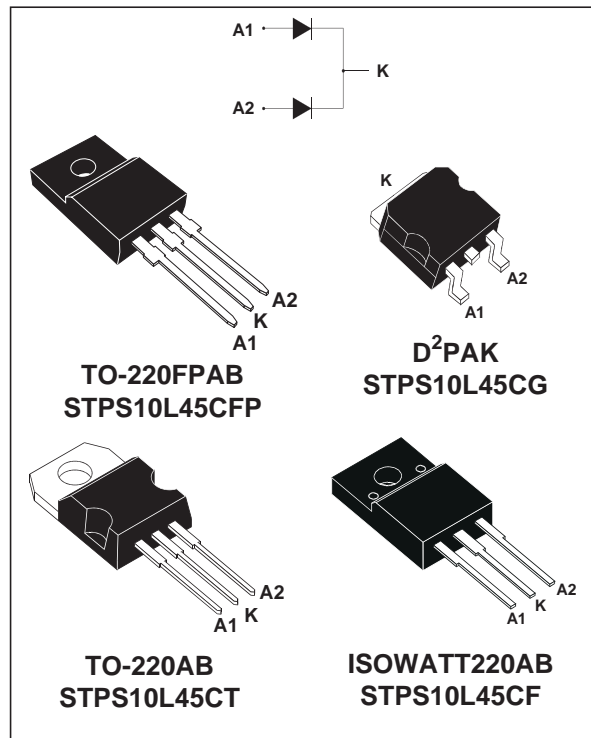

## STPS10L45CT/CG/CF/CFP

### THERMAL RESISTANCES

Symbol	Parameter		Value	Unit	
$R_{th(j-c)}$	Junction to case	TO-220AB D <sup>2</sup> PAK	Per diode	3 1.7	°C/W
$R_{th(c)}$			Total		
$R_{th(c)}$	Junction to case	ISOWATT220AB TO-220FPAB	Coupling	0.35	
$R_{th(j-c)}$			Per diode	5 3.8	°C/W
$R_{th(c)}$			Coupling	2.5	

When the diodes 1 and 2 are used simultaneously :  
 $\Delta T_{j(\text{diode } 1)} = P(\text{diode } 1) \times R_{th(j-c)}(\text{Per diode}) + P(\text{diode } 2) \times R_{th(c)}$

### STATIC ELECTRICAL CHARACTERISTICS (per diode)

Symbol	Parameter	Tests Conditions		Min.	Typ.	Max.	Unit
$I_R^*$	Reverse leakage current	$T_j = 25^\circ\text{C}$	$V_R = V_{RRM}$			0.15	mA
		$T_j = 125^\circ\text{C}$			45	90	mA
$V_F^*$	Forward voltage drop	$T_j = 25^\circ\text{C}$	$I_F = 5\text{ A}$			0.53	V
		$T_j = 125^\circ\text{C}$		$I_F = 5\text{ A}$		0.36	
		$T_j = 25^\circ\text{C}$	$I_F = 10\text{ A}$			0.67	
		$T_j = 125^\circ\text{C}$		$I_F = 10\text{ A}$		0.49	

Pulse test : \*  $t_p = 380\ \mu\text{s}$ ,  $\delta < 2\%$

To evaluate the conduction losses use the following equation :  
 $P = 0.33 \times I_{F(AV)} + 0.026 I_{F(RMS)}^2$

**Fig. 1:** Average forward power dissipation versus average forward current (per diode).

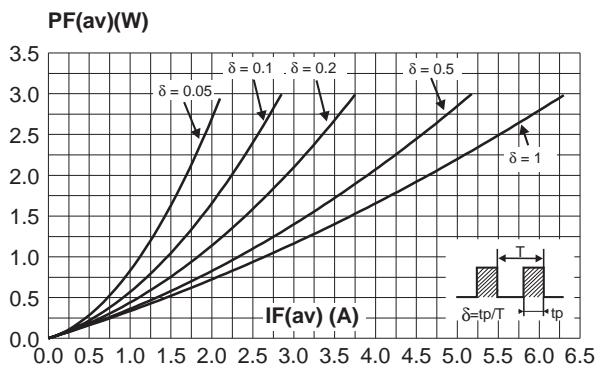

**Fig. 2:** Average forward current versus ambient temperature ( $\delta=0.5$ , per diode).

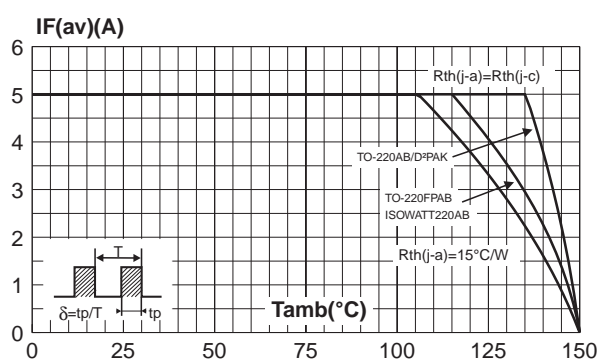

**Fig. 3:** Normalized avalanche power derating versus pulse duration.

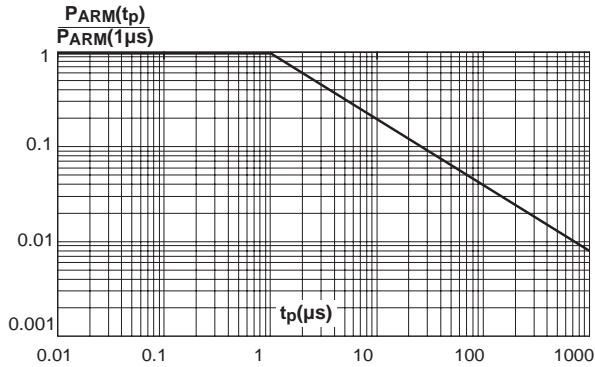

**Fig. 4:** Normalized avalanche power derating versus junction temperature.

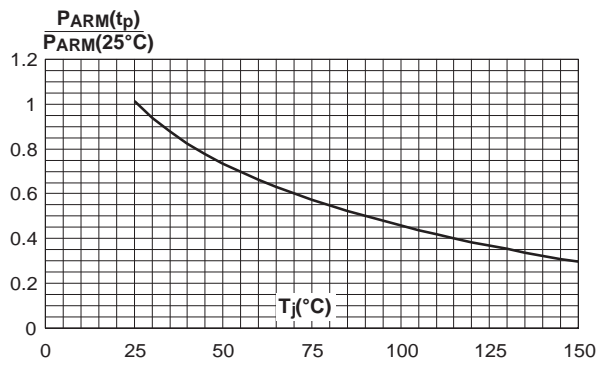

**Fig. 5-1:** Non repetitive surge peak forward current versus overload duration (maximum values, per diode) (TO-220AB and D<sup>2</sup>PAK).

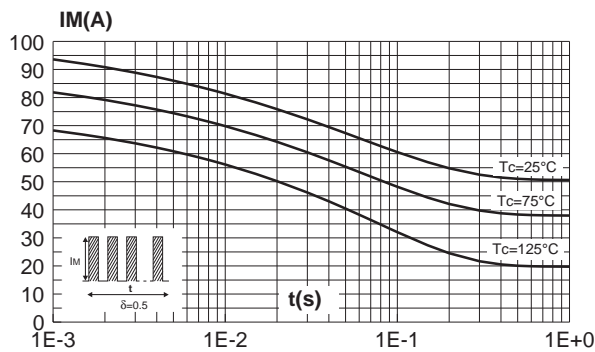

**Fig. 5-2:** Non repetitive surge peak forward current versus overload duration (maximum values, per diode) (ISOWATT220AB, TO-220FPAB).

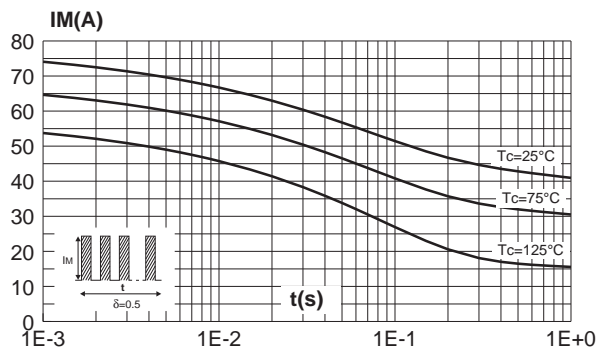

**Fig. 6-1:** Relative variation of thermal impedance junction to case versus pulse duration. (TO-220AB and D<sup>2</sup>PAK).

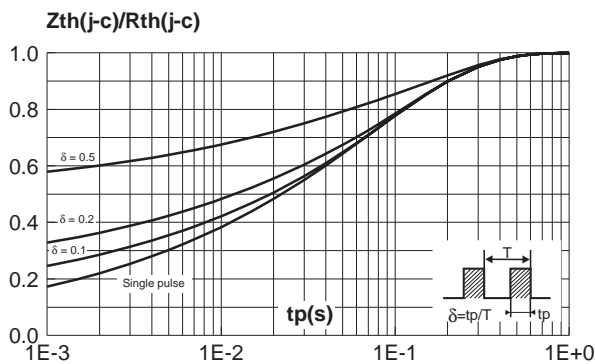

**Fig. 6-2:** Relative variation of thermal impedance junction to case versus pulse duration. (ISOWATT220AB, TO-220FPAB).

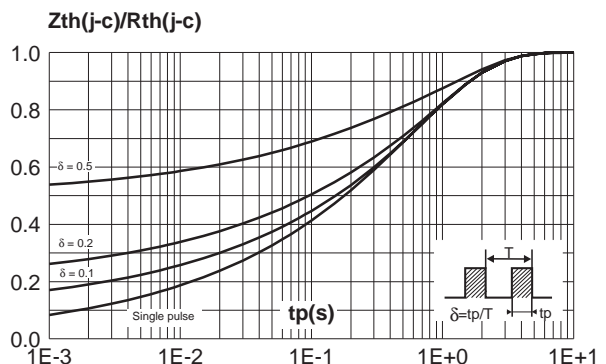

**Fig. 7:** Reverse leakage current versus reverse voltage applied (typical values, per diode).

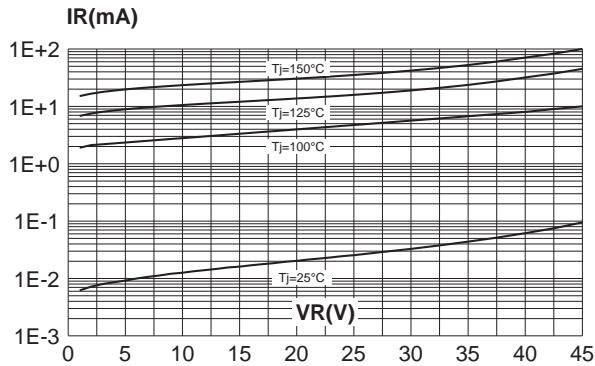

**Fig. 8:** Junction capacitance versus reverse voltage applied (typical values, per diode).

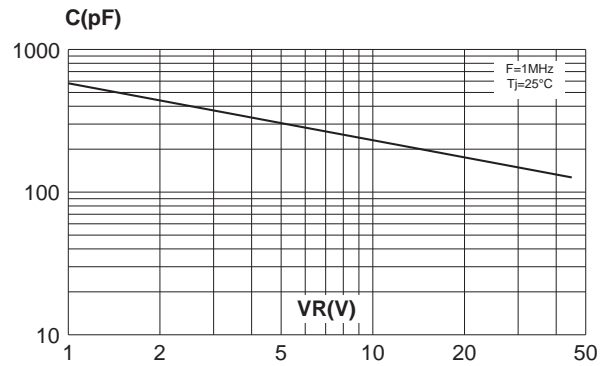

**Fig. 9:** Forward voltage drop versus forward current (maximum values, per diode).

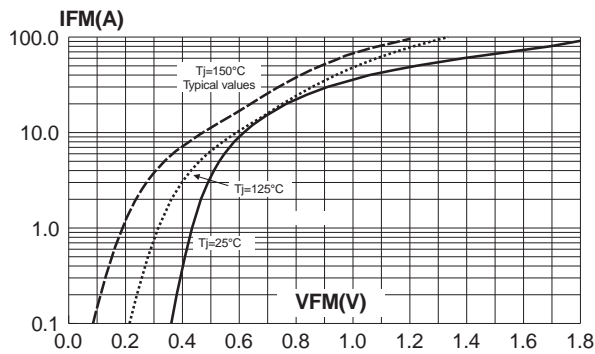

**Fig. 10:** Thermal resistance junction to ambient versus copper surface under tab (Epoxy printed circuit board FR4, copper thickness: 35µm)( D<sup>2</sup>PAK).

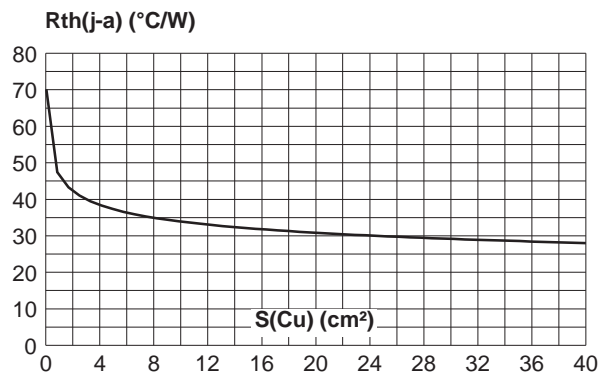

**PACKAGE MECHANICAL DATA**  
TO-220AB

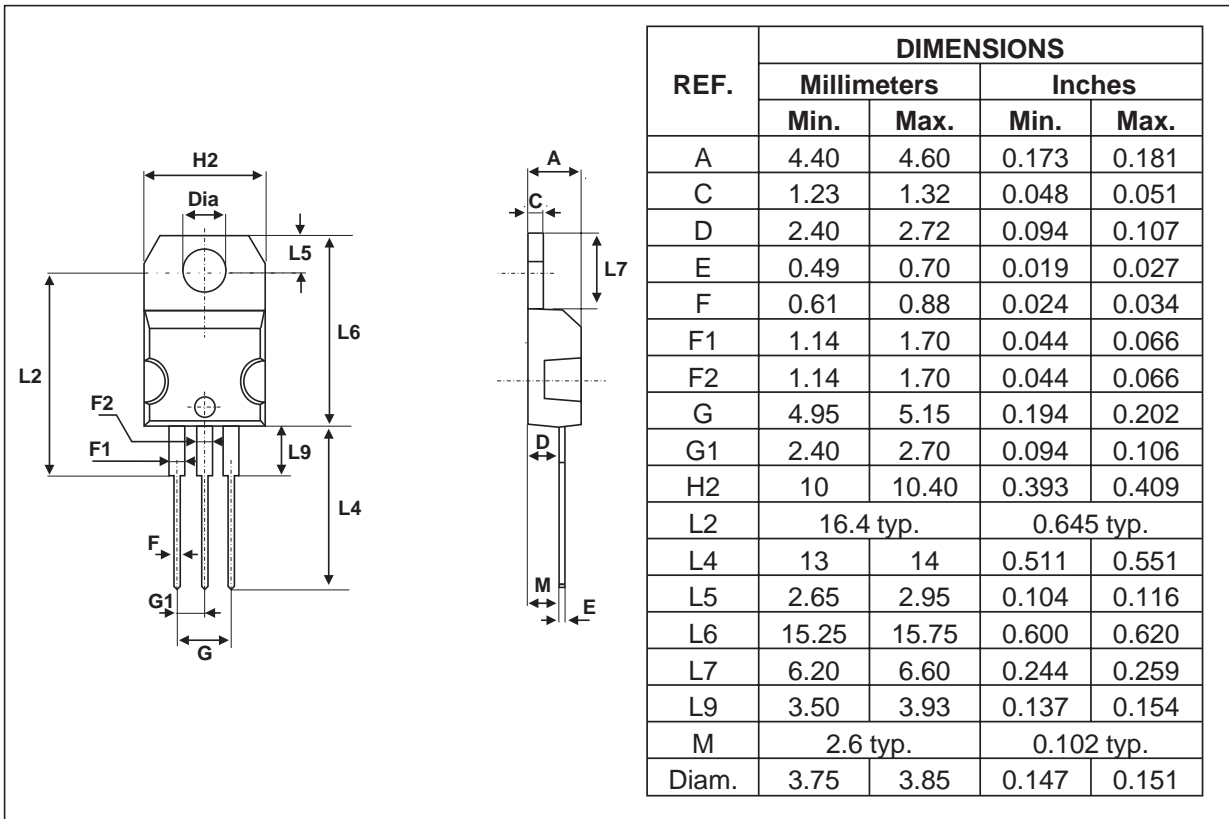

**PACKAGE MECHANICAL DATA**  
TO-220FPAB

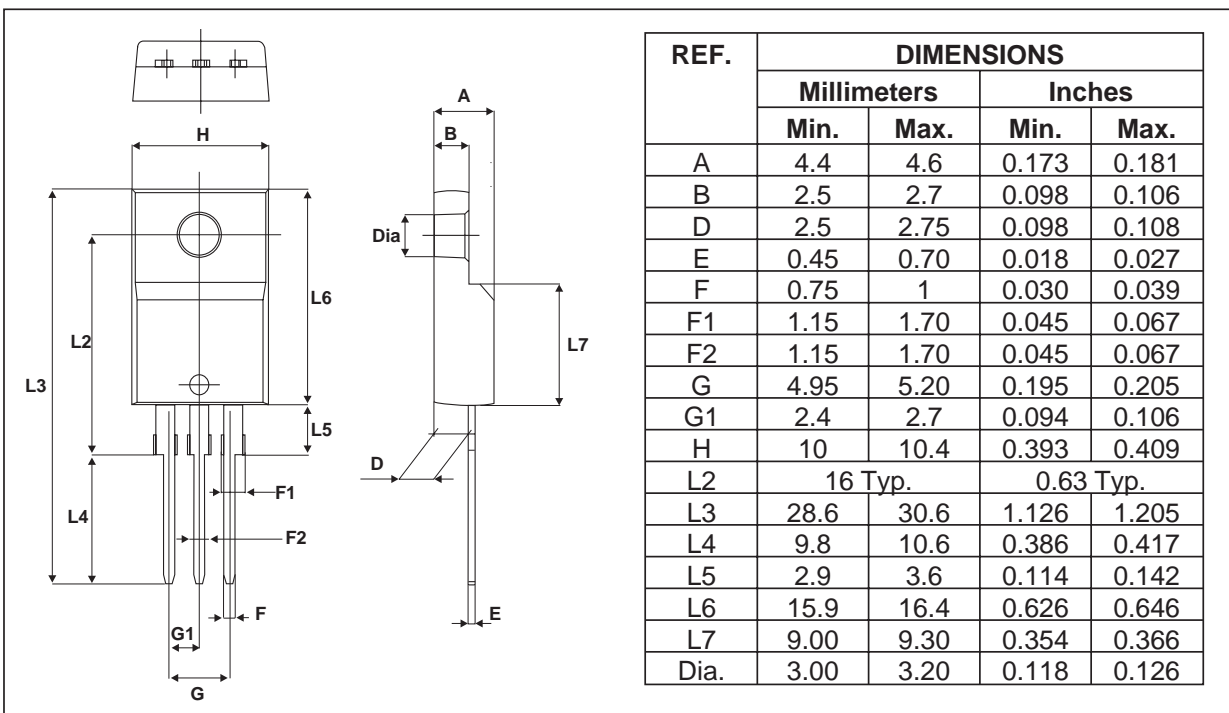

**STPS10L45CT/CG/CF/CFP**

**PACKAGE MECHANICAL DATA**  
D<sup>2</sup>PAK

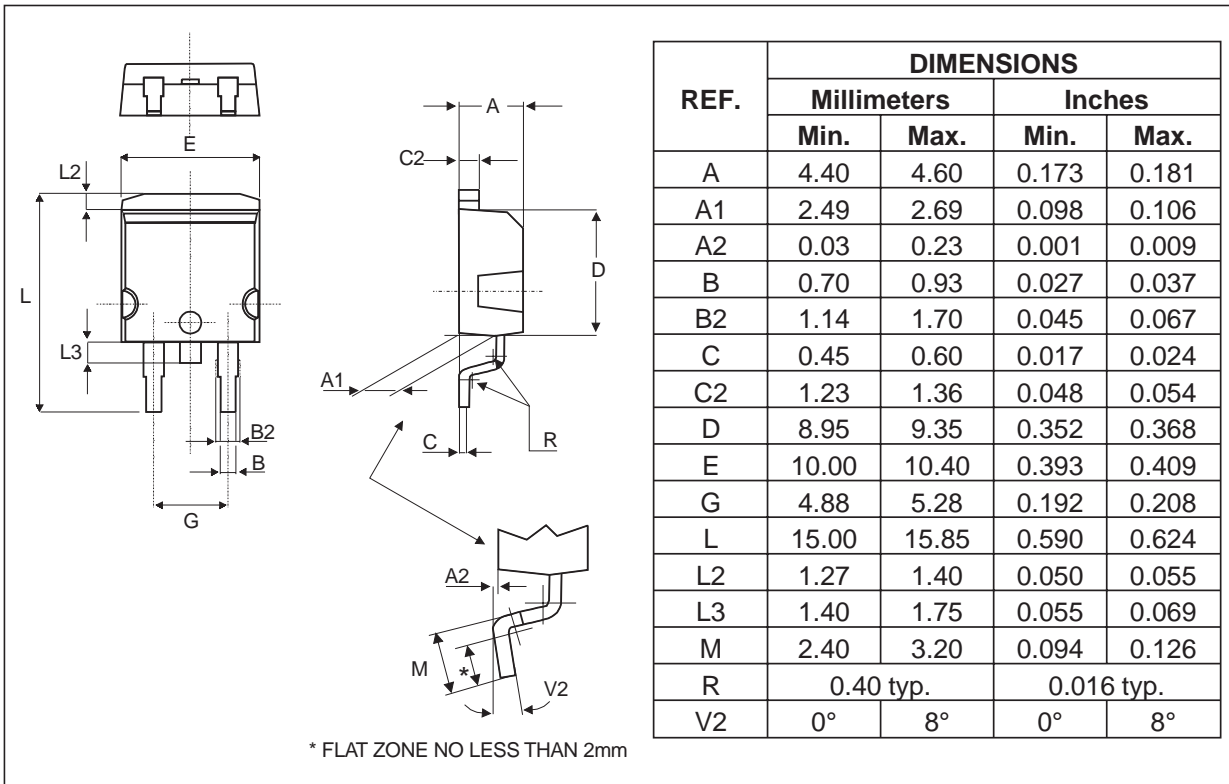

**FOOT PRINT DIMENSIONS (in millimeters)**

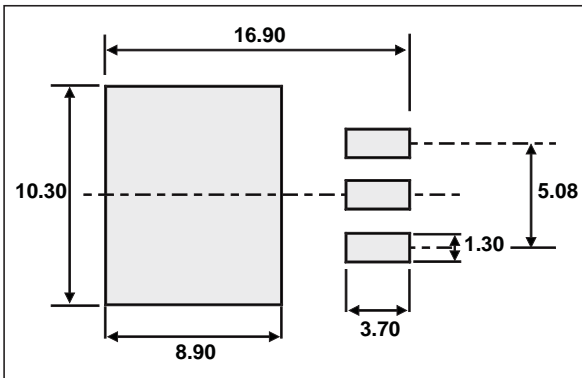

**PACKAGE MECHANICAL DATA**  
ISOWATT220AB

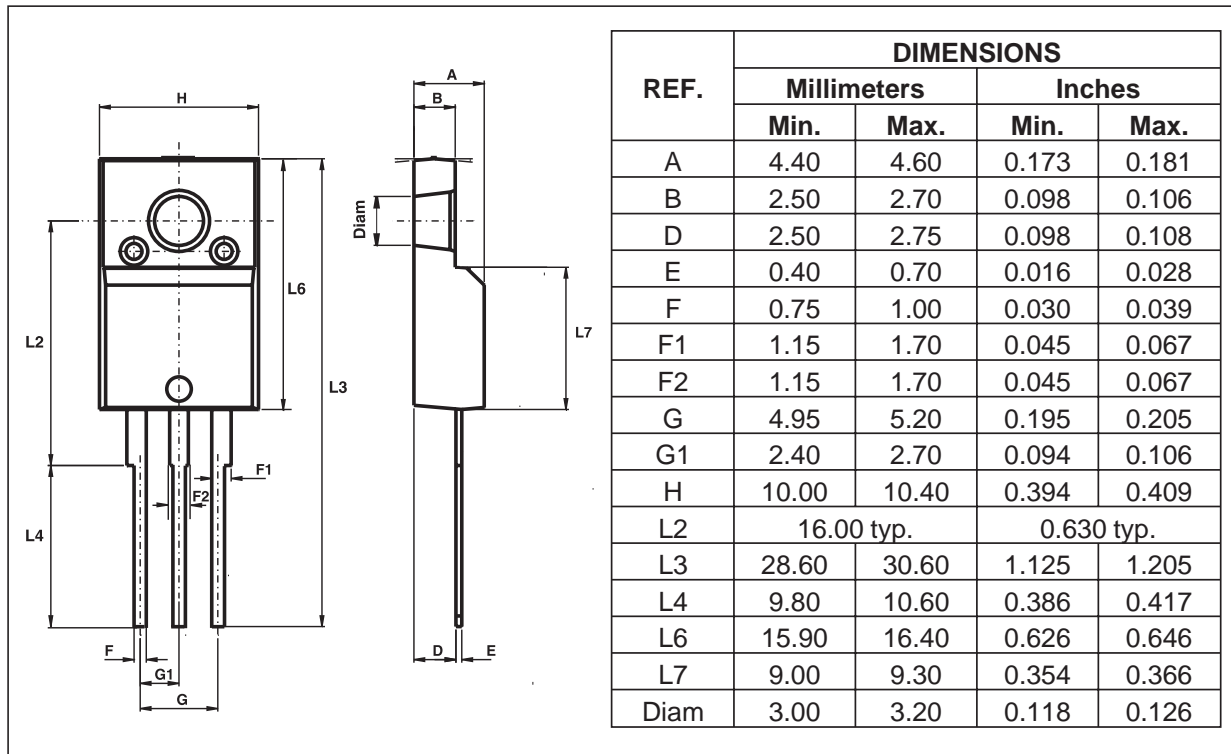

Ordering type	Marking	Package	Weight	Base qty	Delivery mode
STPS10L45CT	STPS10L45CT	TO-220AB	2.23g	50	Tube
STPS10L45CFP	STPS10L45CFP	TO-220FPAB	2 g	50	Tube
STPS10L45CG	STPS10L45CG	D <sup>2</sup> PAK	1.48g	50	Tube
STPS10L45CG-TR	STPS10L45CG	D <sup>2</sup> PAK	1.48g	1000	Tape & reel
STPS10L45CF	STPS10L45CF	ISOWATT220AB	2.08g	50	Tube

- Cooling method : by conduction (C)
- Recommended torque value : 0.55 N.m.
- Maximum torque value : 0.70 N.m.
- Epoxy meets UL94,V0

Information furnished is believed to be accurate and reliable. However, STMicroelectronics assumes no responsibility for the consequences of use of such information nor for any infringement of patents or other rights of third parties which may result from its use. No license is granted by implication or otherwise under any patent or patent rights of STMicroelectronics. Specifications mentioned in this publication are subject to change without notice. This publication supersedes and replaces all information previously supplied. STMicroelectronics products are not authorized for use as critical components in life support devices or systems without express written approval of STMicroelectronics.

The ST logo is a registered trademark of STMicroelectronics  
 © 2003 STMicroelectronics - Printed in Italy - All rights reserved.  
 STMicroelectronics GROUP OF COMPANIES  
 Australia - Brazil - Canada - China - Finland - France - Germany  
 Hong Kong - India - Israel - Italy - Japan - Malaysia - Malta - Morocco - Singapore  
 Spain - Sweden - Switzerland - United Kingdom - United States.

<http://www.st.com>

