

D\*MA Type · Crimp Contact Type

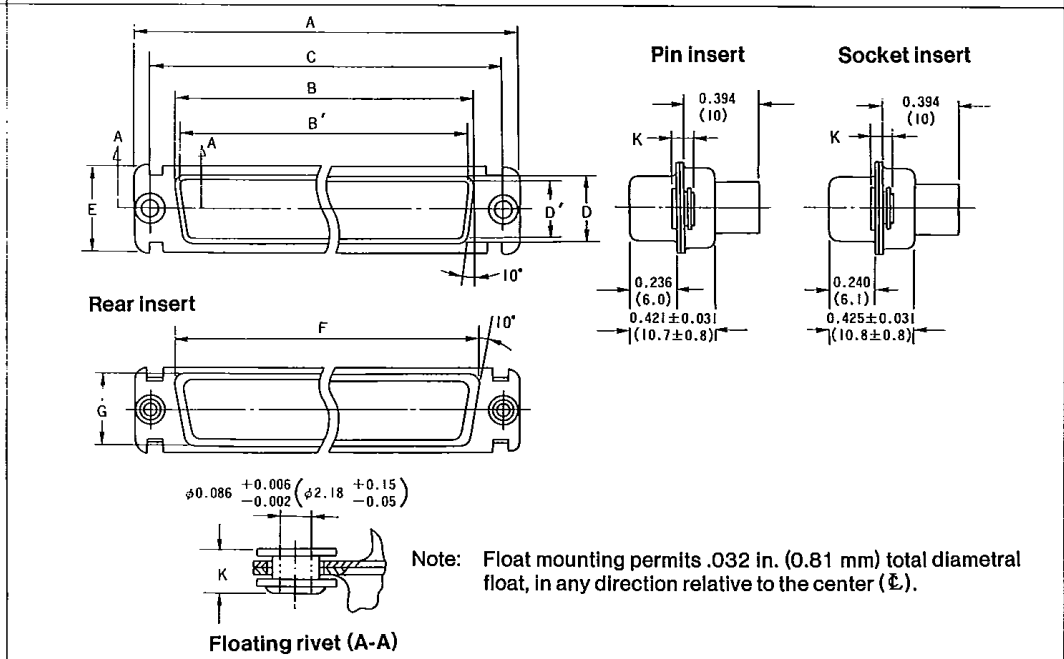
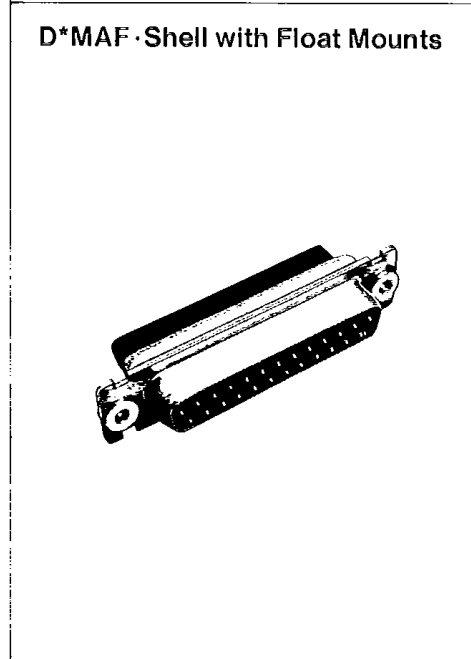
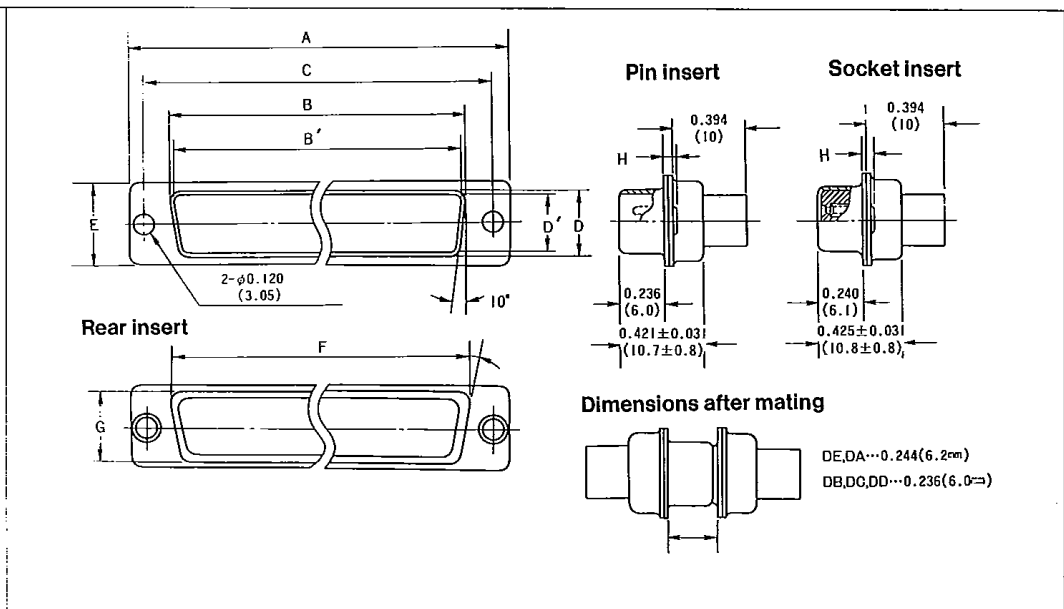
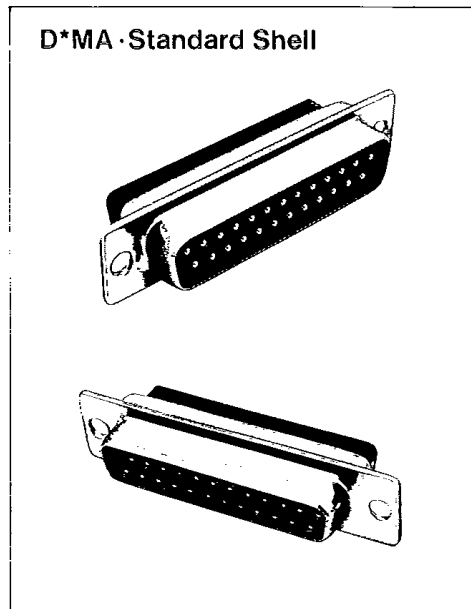

● Only one connector, either pin or socket should be float mounted.

Unit: inch (mm)

No. of Contact	Part Number	A ±.020 (±0.5)	B ±.010 (±0.25)	B' ±.010 (±0.25)	C ±.005 (±0.13)	D ±.010 (±0.25)	D' ±.010 (±0.25)	E ±.020 (±0.5)	F ±.016 (±0.4)	G ±.016 (±0.4)	H ±.016 (±0.4)	K ±.010 (±0.25)
9	Pin <b>DEMA-9P-FO</b>	1.213 (30.8)	—	.665 (16.90)	.984 (24.99)	—	.328 (8.34)	.496 (12.6)	.760 (19.3)	.421 (10.7)	.047 (1.2)	.120 (3.05)
	Socket <b>DEMA-9S-FO</b>	1.213 (30.8)	.640 (16.26)	—	.984 (24.99)	.308 (7.82)	—	.496 (12.6)	.760 (19.3)	.421 (10.7)	.047 (1.2)	.120 (3.05)
15	Pin <b>DAMA-15P-FO</b>	1.539 (39.1)	—	.994 (25.24)	1.312 (33.32)	—	.328 (8.34)	.496 (12.6)	1.083 (27.5)	.421 (10.7)	.047 (1.2)	.120 (3.05)
	Socket <b>DAMA-15S-FO</b>	1.539 (39.1)	.968 (24.59)	—	1.312 (33.32)	.308 (7.82)	—	.496 (12.6)	1.083 (27.5)	.421 (10.7)	.047 (1.2)	.120 (3.05)
25	Pin <b>DBMA-25P-FO</b>	2.087 (53.0)	—	1.536 (39.01)	1.852 (47.04)	—	.331 (8.4)	.496 (12.6)	1.626 (41.3)	.421 (10.7)	.059 (1.5)	.129 (3.28)
	Socket <b>DBMA-25S-FO</b>	2.087 (53.0)	1.508 (38.3)	—	1.852 (47.04)	.308 (7.82)	—	.496 (12.6)	1.626 (41.3)	.421 (10.7)	.047 (1.2)	.120 (3.05)
37	Pin <b>DCMA-37P-FO</b>	2.728 (69.3)	—	2.184 (55.47)	2.500 (63.50)	—	.331 (8.4)	.496 (12.6)	2.272 (57.7)	.421 (10.7)	.059 (1.5)	.129 (3.28)
	Socket <b>DCMA-37S-FO</b>	2.728 (69.3)	2.156 (54.76)	—	2.500 (63.50)	.308 (7.82)	—	.496 (12.6)	2.272 (57.7)	.421 (10.7)	.047 (1.2)	.120 (3.05)
50	Pin <b>DDMA-50P-FO</b>	2.634 (66.9)	—	2.081 (52.86)	2.406 (61.11)	—	.439 (11.16)	.606 (15.4)	2.177 (55.3)	.547 (13.9)	.059 (1.5)	.129 (3.28)
	Socket <b>DDMA-50S-FO</b>	2.634 (66.9)	2.061 (52.34)	—	2.406 (61.11)	.419 (10.65)	—	.606 (15.4)	2.177 (55.3)	.547 (13.9)	.047 (1.2)	.120 (3.05)

● To order float mount, add "F". For example: DAUF-15S-FO.  
 ● To order glass-filled nylon insulator, part number becomes D\*C. For example: DAC-15S-FO

# ● COMPACT, HIGHLY RELIABLE RECTANGULAR CONNECTORS

# D Sub Series

## ■ INTRODUCTION

The D Subminiature series connectors are compact, light, and highly reliable rectangular connectors meeting current user demands for high density and miniaturization, for use in computers and electronic equipment.

The versatile D Sub series allow its users to select the plug (pin side) and receptacle (socket side) based on five shell sizes and five basic variations in the number of contact positions (9, 15, 25, 37, and 50 are standard). Both machined and stamped contact versions are available.

Wire termination types include crimp contact, insulation displacement, solder, printed-circuit-board through hole, and wire-wrap types. D Sub connectors offer versatile connection modes. A large lineup of accessories permits cable-to-panel, cable-to-cable, and printed circuit board-to-cable, in addition to rack and panel interconnect.

D Sub series connectors offer users a wide product range to choose from, to service general purpose, electromagnetic interference (EMI) control, and other operating conditions.

### Table of Contents Page

INTRODUCTION.....	2~4
APPLICATIONS.....	3
FEATURES.....	5
GENERAL SPECIFICATIONS.....	6~9
CRIMP CONTACT TYPE.....	10~16
● D*U.....	11~13
● D*MA.....	14~16
INSULATION DISPLACEMENT TYPE.....	17~23
● D*SP.....	18~19
● Insulation Displacement Procedures and Applicable Cables.....	20~21
● Cable Assembly.....	22~23
SOLDER TYPE.....	24~31
● D*N/D*UL.....	24~25
● D*M.....	26~30
● IEC-IB Cable Assembly.....	31
THROUGH HOLE TYPE.....	32~41
● D*LC.....	33~35
● D*A/D*T.....	36~39
● D*U Contact.....	40~41
ELECTROMAGNETIC INTERFERENCE (EMI) CONTROL TYPE.....	42~47
● D*F.....	43~45
● Clamp Hood.....	46
● A screw lock assembly with the mating half is available.....	47
HIGH-DENSITY D02 SERIES.....	48~49
ALL-PLASTIC DEL SERIES.....	50~51
ACCESSORIES.....	52~61
D SUB CONNECTOR MOUNTING DIMENSIONS.....	62~63
CONNECTOR CONNECTION AND ASSEMBLY.....	64~68
LIST OF D SUB SERIES PRODUCTS.....	69~72

### CRIMP CONTACT TYPE

#### D\*U ..... 11 Page

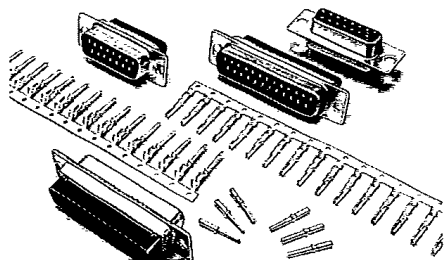

- Crimp snap-in Contacts
- Two-types — Low cost stamped contacts and machined contacts.
- Labor for connections greatly reduced using manual and high-speed semiautomatic crimping machines.
- Low-cost, easy-to-use multi-purpose connectors
- Wire sizes: AWG No. 18 to 30
- Printed circuit board contacts are also available — straight and right angle types
- Number of conductors: 9, 15, 25, 37, or 50

#### D\*MA ..... 14 Page

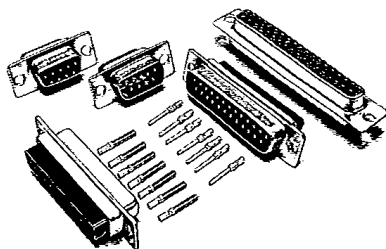

- High reliability machined contacts; socket contact tines are protected by stainless steel sleeves.
- The insulator is made of glass-filled diallyl phthalate.
- Number of conductors: 9, 15, 25, 37, or 50

### INSULATION DISPLACEMENT TYPE

#### D\*SP ..... 18 Page

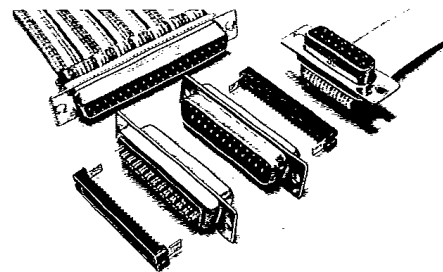

- A self-piercing type to connect all conductors in a flat ribbon cable simultaneously without removing the cable sheath.
- Flat ribbon cables with pitches of .050 or .054 inches (1.27 or 1.38 mm) can be connected.
- Compact connector style only can be .787 inches (20 mm) in behind panel depth (an optional strain relief mounted after making connections).
- Compact and easy-to-operate manual and semiautomatic terminating machines are available.
- Cable assemblies of various types are also available, as are also D\*SP to other—IDC connector assemblies.
- Number of conductors: 9, 15, 25, or 37

# FEATURES

## • Five different shell sizes and numbers of conductors

The connector housing is compact and rectangular. The contacts and insulators are contained in a rugged steel shell. There are five shell sizes (E, A, B, C, and D), respectively with standard contact counts of 9, 15, 25, 37, and 50. Special layouts to accept coaxial, high-voltage, and high-current contacts are also available.

E	A	Shell Size:
9	15	Number of Conductors:

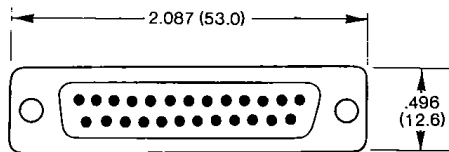
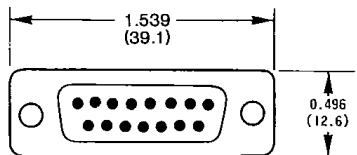
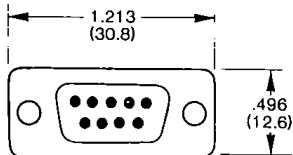

B	Shell Size:
25	Number of Conductors:

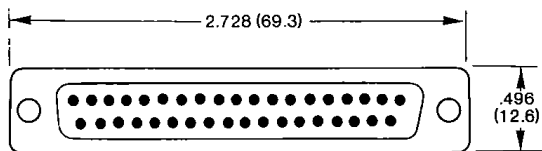

C	Shell Size:
37	Number of Conductors:

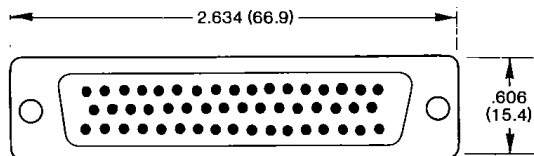

D	Shell Size:
50	Number of Conductors:

### Special Layouts (D\*M Type)



### • Fail-Safe Polarizing Mechanism

The shell connecting part is keystone trapezoidal which inherently prevents incorrect coupling.

Can be mated

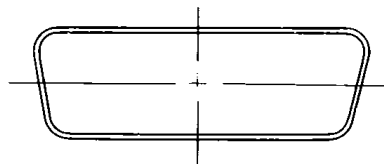

Cannot be mated

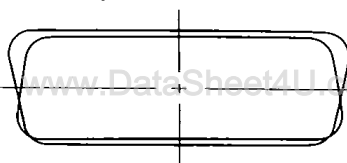

### • Official Standards

D Sub connectors conform to many international standards including:

Japan Industrial Standards

JIS-C-6361

JIS-C-6366

JIS-C-6367

Japan Defense Agency Standards

NDSXC 6116

DSP C 6242

US Military Standards

MIL-C-24308

A-17-03  
A-17-05  
A-61-11  
A-65-07

### • Shell Type

The shell profile comes in a panel-mounting standard type and floating type (the latter aids in rack-to-panel connection).

#### Standard Type

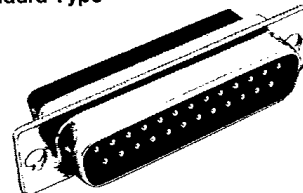

#### Floating Type

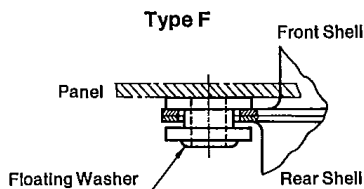
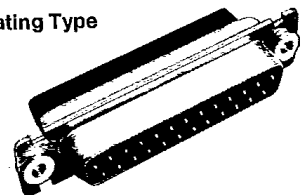

The floating washer moves .030 in. (0.4 mm) in any direction relative to the center (⌀).

### • Close Entry Construction

Socket insulators have a closed entry construction which prevents entry of oversized contacts or probes.

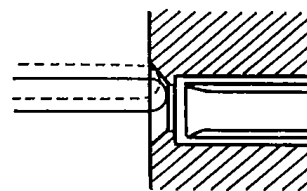

### • Compatibility

Individual connector types are interchangeable as are the accessories.

General Specification (Principal Performance)

A-65-07

Division	Item	Performance						
		D*		D* M	D* U			
		Stamped Contacts	Machined Contacts		Stamped Contacts	Machined Contacts	Machined Contacts	
Electrical Performance	Rated Current	5A						
	Dielectric Strength (See Level)	AC 1250 V r.m.s			AC 1000 V r.m.s			
	Insulation Resistance	5000 M-ohm or greater						
	Contact Resistance	2.7 m-ohm or less (5.0 m-ohm or less after the life and after salt spray). Test current: AWG No. 20, 7.5 a; AWG No. 22, 5; AWG No. 24, 3. *Through hole (PCB mounted connectors not applicable).						
Mechanical Performance	Contact Force	Mating force: 28.4~408 g Unmating force: 28.4~272 g	Mating force: 28.4~340 g Unmating force: 28.4~227 g	Mating force: 28.4~408 g Unmating force: 28.4~272 g				
	Connector Mating/Unmating Force	Mating force: (408 g × number of contacts) or less. Unmating force: (272 g × number of contacts) or less.	Mating force: (340 g × number of contacts) or less. Unmating force: (227 g × number of contacts) or less.	kg or less	Stamped Contact		Machined	
					Mating Force	Unmating Force	Mating Force	
					9	3.7	2.4	3.1
					15	6.1	4.1	5.1
25					10.2	6.8	8.5	
37	15.1	10.1	12.6					
50	20.4	13.6	17.0					
Contact Retention Force (kg or larger)	D*		D* M	D* U				
	Stamped Contacts	Machined Contacts		Stamped Contacts	Machined Contacts	Machined Contacts		
	4.5		4.1	3.6		4.5		
Vibrations	(1) The current (discontinuity) shall not exceed one (1) microsecond. (2) Shall pass the dielectric strength test at sea level. (3) Parts shall be free of cracks, damage, and looseness.							

Contacts		D * MA	D * SP			Description
			1A			
			AC 600 V r.m.s			There shall be no breakdown discharge after the test voltage (see at left) is applied for one minute between adjacent contacts and between shell and closest contact.
			1000 M-ohm or greater			The value specified at the left shall be met when 500 VDC is applied and measured between adjacent contacts and between contact and the shell.
			15 m-ohm or less (30 m-ohm or less)			Mate pin and socket contacts terminated to wire, apply a test current, then measure by the voltage drop method. The value at the left shall be satisfied.
		Mating force: 28.4 ~340 g Unmating force: 28.4 ~227 g			Mate and unmate the largest test pin (1.041 $\phi_{-0.003}^{+0}$ ) three times. Measure mating/unmating forces during the third cycle. Mate and unmate the smallest test pin (0.991 $\phi_{-0.003}^{+0}$ ) and measure mating/unmating forces during first cycle. The value at the left should be satisfied.	
Contact	Mating force: (340 g × number of contacts) or less. Unmating force: (222 g × number of contacts) or less.	kg or less	Mating Force	Unmating Force	Mate and unmate the connector on the pin side while completely anchoring the connector on the socket side. The measured mating and unmating forces shall satisfy the values at the left.	
Unmating Force						
2.0	9	3.1	2.0			
3.4	15	5.1	3.4			
5.7	25	8.5	5.7			
8.4	37	12.6	8.4			
11.3						
		D * MA	D * SP			Apply an axial load to the contacts
		4.5	1.0			
					Vibration to supply full sine wave .06 (1.52 mm) in total amplitude or 10 G, whichever is smaller, over a frequency range 10 to 500 Hz. The full frequency range is applied both ways for 15 minutes. This cycle is repeated 12 times each in the three axial directions. All contacts to be connected serially and apply a 100-mA current during the test.	

General Specification (Principal Performance)

A-61-11  
A-65-07

Division	Item	Performance			
		D*		D* M	
		Stamped Contact	Machined Contact		Stamped Contact
Mechanical Performance	Contact Retention Force (kg or larger)	4.5		4.1	3.6
	Shock	(1) Current discontinuity may not exceed one (1) microsecond during the test. (2) Shall pass the dielectric strength test at sea level. (3) Parts shall be free of cracks, damage, and looseness.			
	Life	(1) Contact resistance 5 m-ohm or less. (D* SP: 30 m-ohm or less.) (2) Contact mating/unmating force Refer to the previous section. (3) Connector mating/unmating force			
Environmental Performance	Temperature Cycle		D*	D* M	
		Low Temperature	-67°F (-55°C)	-85°F (-65°C)	
		High Temperature	+257°F (+125°C)	+302°F (+150°C)	
		(1) The connector shall be free of cracks and damage. (2) Shall pass the dielectric strength test at sea level.			
	Humidity Resistance	Immediately after test (1) Insulation resistance: 1 M-ohm or higher. (2) Dielectric strength: 600 VAC rms or higher. (D* SP: 400 VAC rms or higher.) After storing for 24 hours (1) Insulation resistance: 1000 M-ohm or higher.			
Corrosion	(1) There shall be no detrimental corrosion that affects the base metal and connector (2) Contact resistance: 5 m-ohm or less. (D* SP: 30 m-ohm or less.)				

D * U			Description
Machined Contact	D * MA	D * SP	
4.5	4.5	1.0	Apply an axial load to the contacts.
			Apply an impact of 50 G for 11 ms ten times each in three axial directions during acceleration. All contacts connected in series, and apply a 100-mA current during the test.
			The values specified at the left shall be satisfied after mating and unmating male and female connectors 500 times.
D * U	D * MA	D * SP	Increase and decrease the temperature to the temperatures specified at the left 30 minutes each continuously for five cycles.
-85°F (-65°C)	-85°F (-65°C)	-67°F (-55°C)	
+257°F (+125°C)	+302°F (+150°C)	+221°F (+105°C)	
			Stored at 65°C and 90 to 98% relative humidity for ten days. Wipe off condensation on the surface. The measured values shall satisfy the values mentioned at the left.
connection.			Expose to 35°C and 5% concentration salt spray for 48 hours, wash with flowing water, then dry in an air-circulated oven at 38 ± 3°C for 12 hours.

## Crimp Contact Type Connector

### D\*MA Type

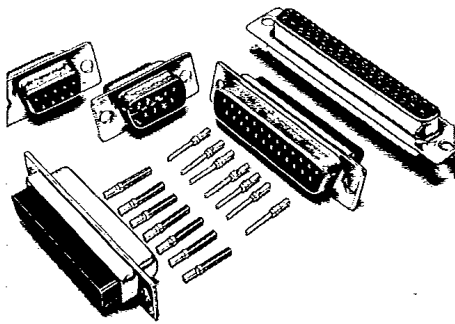

### FEATURES

#### • Crimp Snap-In Contacts

Termination is by crimp contacts using standard crimp tools. Terminated contacts are inserted through the rear of the insulators. The inserted contacts are securely held by individual metal clips within each of the insulated cavities. If a circuit change occurs, or when correcting an incorrect wire, the contacts can be removed easily using simple plastic or metal tools.

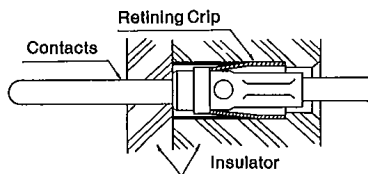

#### • Stable, highly reliable socket contact

The spring part of the socket contact has a closed-entry construction covered by a stainless steel sleeve to enclose the tines and assure contact stability.

The insulators are made of glass-impregnated diallyl phthalate which excels in resistance to heat and weather, dimensional stability, etc. Flame retardant per UL94V-0. Let us explain what is available.

## HOW TO ORDER

# DAMA -15P-FO DAMAF-15S-FO

- -FO: Connector less contacts (not stamped on connector)
- Contact type: P—Pin; S—Socket
- Contact arrangement: 9, 15, 25, 37, 50
- Mounting type: No designator—Standard; F—Float mount
- Connector type: Monoblock insert, crimp termination type
- Connector size: E, A, B, C, D
- Series prefix

- Place orders separately for connector bodies and necessary contacts (see page 16)
- Place orders for accessories (see page 52 to 61) separately from those for connector bodies.

#### Example of combination of connector

Use a pair of connectors that has the same shell size and contact arrangement but different contact sex.

Example: Body DAMA-15P-FO (15 conductor pin side)—  
DAMA-15S-FO (15 conductor socket side)  
contact 330-5291-900 (pin contact)—  
031-5130-000 (socket contact)

### STANDARD DATA

#### • Materials/Finishes

Component	Material	Finish
Contacts	Copper alloy (Sleeve of socket contact... stainless steel)	Gold plate
Insulator	Glass-filled diallylphthalate	Color: Dark green
Shell	Steel	Yellow chromate over zinc plate
Crimp	Beryllium copper	Ebonizing treatment

#### • ELECTRICAL DATA

Current rating	5 amp
Dielectric rating	1,000 V AC r.m.s
Insulation resistance	5,000 megohms min.
Contact resistance	2.7 milliohms max.

- Details... See pages 6 to 9.
- How to terminate and assemble connectors... See pages 64 to 66.

### CONTACT ARRANGEMENT

Face view pin insert

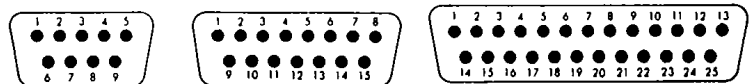

Shell size	E	A	B
Contact arrangements	9	15	25

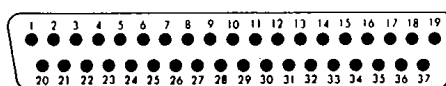

Shell size	C	D
Contact arrangements	37	50