

OKI semiconductor

MSM16812

2,048-BIT SERIAL E²PROM

FEATURES

- CMOS Floating Gate Technology
- Single +5-volt supply
- Eight pin plastic package
- 128 x 16 or 256 x 8 user selectable serial memory
- Microwire™ compatible
- Self timed programming cycle with Auto-Erase
- Word and chip erasable
- Operating range 0°C to 70°C
- 10,000 erase/write cycles
- 10 year data retention

PIN CONFIGURATION (TOP VIEW)

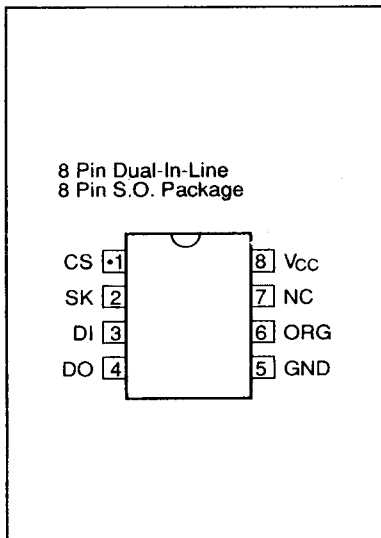

FUNCTIONAL BLOCK DIAGRAM

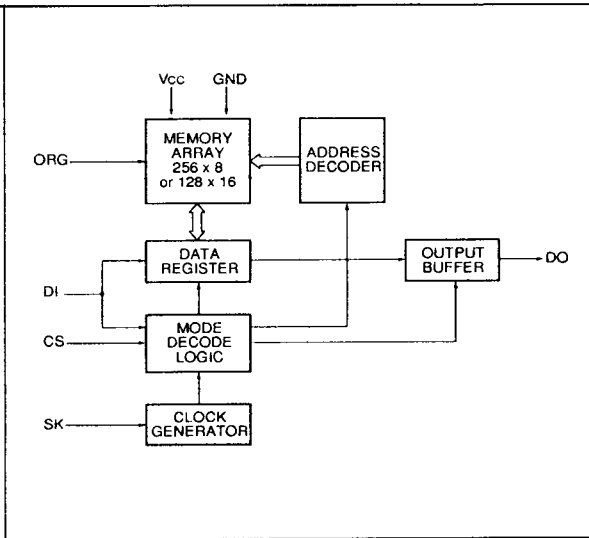

PIN FUNCTIONS

CS	Chip Select	ORG	Memory Array Organization Selection Input. When the ORG pin is connected to +5 V, the 128 x 16 organization is selected. When it is connected to ground, the 256 x 8 organization is selected. If the ORG pin is left unconnected, an internal pull-up device selects the 128 x 16 organization.
SK	Clock Input		
DI	Serial Data Input		
DO	Serial Data Output		
V _{cc}	+5 V Power Supply		
NC	No Connection		
GND	Ground		

INSTRUCTION SET							Comments
Instruction	Start Bit	Opcode	Address		Data		
			256 x 8	128 x16	256 x 8	128 x16	
READ	1	1 0	A ₇ - A ₀	A ₆ - A ₀			Read Address A _N - A ₀
ERASE	1	1 1	A ₇ - A ₀	A ₆ - A ₀			ERASE Address A _N - A ₀
WRITE	1	0 1	A ₇ - A ₀	A ₆ - A ₀	D ₇ - D ₀	D ₁₅ - D ₀	WRITE Address A _N - A ₀
EWEN	1	0 0	11XXXXXX	11XXXXXX			Program Enable
EWDS	1	0 0	00XXXXXX	00XXXXXX			Program Disable
ERAL	1	0 0	10XXXXXX	10XXXXXX			Erase All Addresses
WRAL	1	0 0	01XXXXXX	01XXXXXX	D ₇ - D ₀	D ₁₅ - D ₀	Program All Addresses

Power-On Data Protection Circuitry: During power-up, all modes of operation are inhibited until V_{CC} reaches a level of approximately 3.0 volts. During power-down, the source data protection circuitry inhibits all modes when V_{CC} falls below the voltage range of approximately 3.0 volts.

**ELECTRICAL CHARACTERISTICS
ABSOLUTE MAXIMUM RATINGS**

Rating	Symbol	Conditions	Value	Unit
Supply Voltage	V _{CC}	Ta = 25°C	-0.3 ~ 7	V
Input Voltage	V _I		-0.3 ~ V _{CC} + 0.3	V
Output Voltage	V _O		-0.3 ~ V _{CC} + 0.3	V
Storage Temperature	T _{STG}		-55 ~ + 150	°C

8

NOTE: Permanent device damage may occur if ABSOLUTE MAXIMUM RATINGS are exceeded. Functional operation should be restricted to the conditions as recommended. Exposure to ABSOLUTE MAXIMUM RATINGS for extended periods may affect device reliability.

RECOMMENDED OPERATING RANGE

Parameter	Symbol	Conditions	Range	Unit
Supply Voltage	V _{CC}	-	5 ± 10%	V
Temperature Range	Ta	-	0 ~ 70	°C
Data Hold Temperature	Ta	-	0 ~ 70	°C

DC CHARACTERISTICS

(V_{CC} = 4.5V to 5.5V, T_a = 0°C ~ 70°C, unless otherwise specified.)

Parameter	Symbol	Conditions	Value		Unit	Notes
			Min	Max		
Supply Voltage	V _{CC}	–	4.5	5.5	V	
Power Supply Current	I _{CC1}	V _{CC} = 5.0 V CS = 1	–	3	mA	
	I _{CC2}	V _{CC} = 5.5 V CS, SK, DI = 0V DO, ORG = OPEN	–	100	µA	
"L" Input Voltage	V _{IL}	–	–0.1	0.8	V	
"H" Input Voltage	V _{IH}	–	2.0	V _{CC} +1	V	
"L" Output Voltage	V _{OL}	TTL I _{OL} = 2.1 mA	–	0.4	V	
		CMOS I _{OL} = 100 µA	–	0.1	V	
"H" Output Voltage	V _{OH}	TTL I _{OH} = -400 µA	2.4	–	V	
		CMOS I _{OH} = -100 µA	V _{CC} ^{0.5}	–	V	
Input Leakage Current	I _{LI}	V _{in} = 5.5 V	–	10	µA	
Output Leakage Current	I _{LO}	V _{out} = 5.5 V CS = 0	–	10	µA	

AC CHARACTERISTICS

Parameter	Symbol	Conditions	Value			Unit	Notes
			Min	Typ	Max		
CS Setup Time	t _{CSS}	–	50	–	–	ns	
CS Hold Time	t _{CSH}	–	0	–	–	ns	
DI Setup Time	t _{DIS}	–	100	–	–	ns	
DI Hold Time	t _{DIH}	–	100	–	–	ns	
Output Delay to 1	t _{PD1}	CL = 100pF	–	–	500	ns	
Output Delay to 0	t _{PDO}	V _{OL} = 0.8, V _{OH} = 2.0	–	–	500	ns	
Output Delay to HIZ	t _{HZ}	V _{IL} = 0.45V, V _{IH} = 2.4	–	–	100	ns	
Erase/Write Pulse Width	t _{EW}	–	–	–	10	ms	
Min CS Low Time	t _{CSMIM}	–	250	–	–	ns	
Min SK High Time	t _{SKHI}	–	250	–	–	ns	
Min SK Low Time	t _{SKLOW}	–	250	–	–	ns	
Output Delay to Status Valid	t _{SV}	CL = 100pF	–	–	500	ns	
Maximum Frequency	SK _{MAX}	–	0	–	1	MHz	

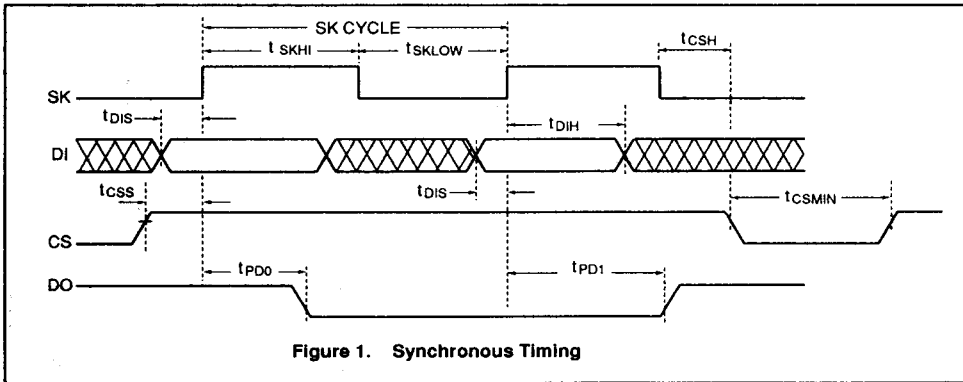

Figure 1. Synchronous Timing

DEVICE OPERATION

The MSM16812 has 7 instructions that allow it to read, erase, or write. Each instruction consists of a start bit logical 1, an opcode field (2 bits or 4 bits) and an address field (6 or 7 bits).

The DO pin is a multiplexed pin. It is used as Data Out during the Read mode. It can also be used as a Ready Busy status indicator in programming mode. In all the other modes DO is tri-stated.

During power-up all modes of operation are disabled and the device comes up in a program disabled state. An EWEN instruction must be issued before starting to program.

At power-down, when V_{CC} falls below a level of approximately 3V, the data protection circuitry inhibits all modes of operation and an EWDS instruction is executed internally.

READ

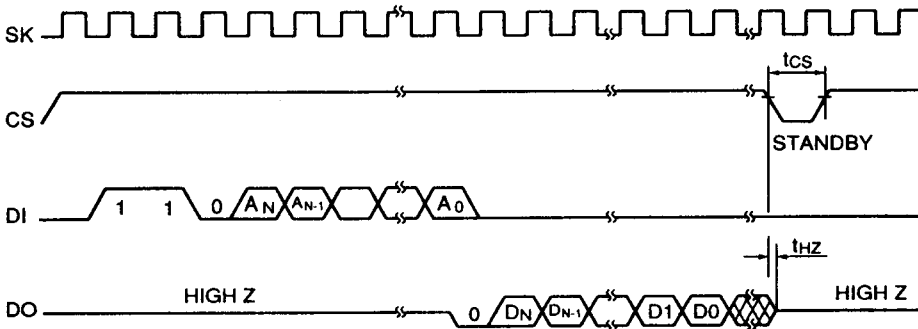

Organization	A _N	D _N
256 x 8	A ₇	D ₇
128 x 16	A ₆	D ₁₅

The READ instruction reads the contents of the addressed register. It outputs data serially on the DO pin. After the instruction is decoded, a dummy bit (logical 0) precedes the output data string.

EWEN/EWDS (ERASE/WRITE ENABLE AND DISABLE)

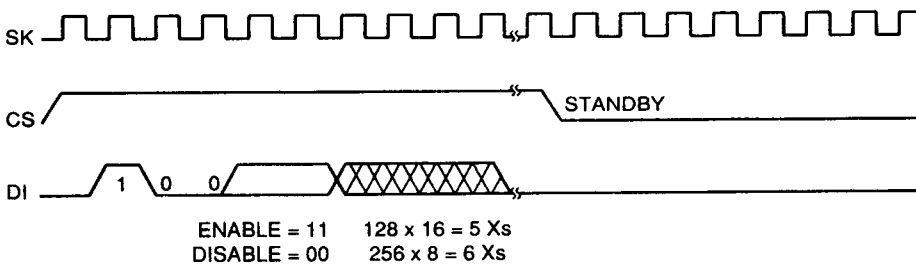

After power-up and before starting any programming instruction, the EWEN instruction must be issued. Once it is issued, it remains active until an EWDS instruction takes place. The EWDS instruction prevents accidental programming of the part. The READ instruction is independent from the EWEN and EWDS instructions.

ERASE

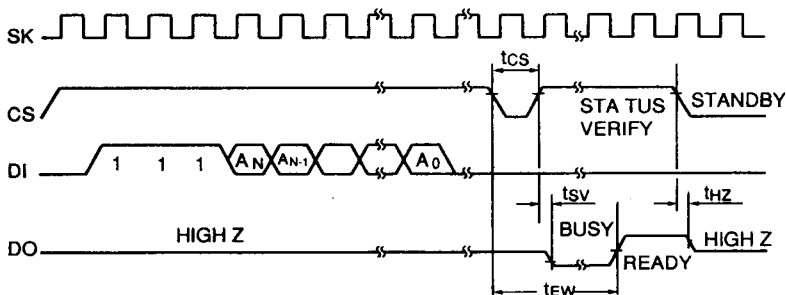

After an ERASE instruction is shifted in, CS is dropped low. This sets the beginning of the self timed erase sequence. If CS is brought high (after observing the t_{cs} spec), the DO pin acts as a status indicator. It remains low so long as the chip is programming. It goes high after all the bits of the addressed register are set to a logical 1.

WRITE

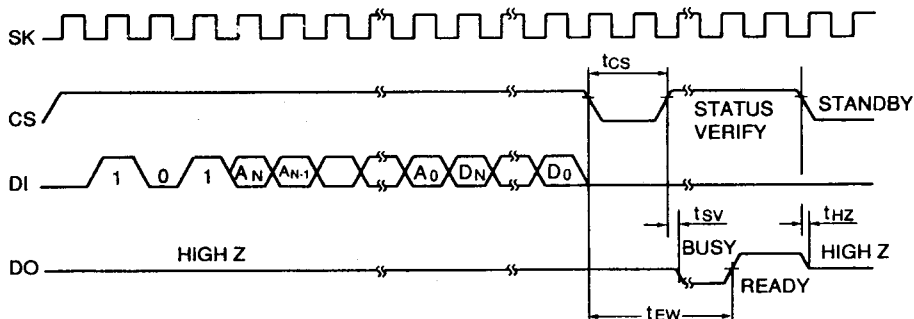

After a WRITE instruction is shifted in with its corresponding 8 or 16 bits of data, CS is dropped low. This sets the beginning of the self-timed programming sequence. If CS is brought high during the programming time (after observing the t_{cs} specification), the DO pin acts as a status indicator. It remains low as long as the chip is programming. It goes high after all the bits of the addressed register are set to their proper values. With the MSM16812 it is NOT necessary to erase a memory location before the WRITE instruction.

Organization	A_N	D_N
256 x 8	A_7	D_7
128 x 16	A_6	D_{15}

ERAL (ERASE ALL)

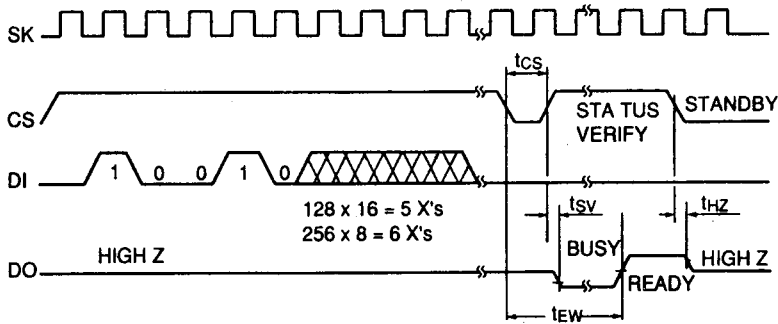

This instruction erases the whole chip. Except for its different opcode, the ERAL instruction is identical to the ERASE instruction.

WRAL (WRITE ALL)

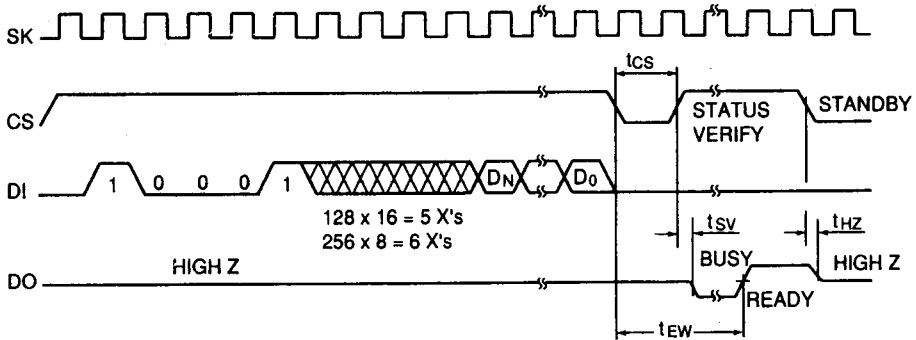

This instruction writes to all the registers simultaneously. All the registers must be erased before a WRAL operation. Except for its different opcode, the WRAL instruction is identical to the WRITE instruction.