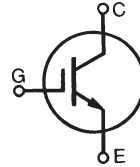


# HiPerFAST™ IGBT

**IXGH 40N60B2**  
**IXGT 40N60B2**

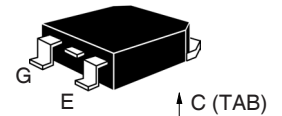
$V_{CES} = 600 \text{ V}$   
 $I_{C25} = 75 \text{ A}$   
 $V_{CE(sat)} < 1.7 \text{ V}$   
 $t_{fi\text{typ}} = 82 \text{ ns}$

Optimized for 10-25 KHz hard switching and up to 150 KHz resonant switching

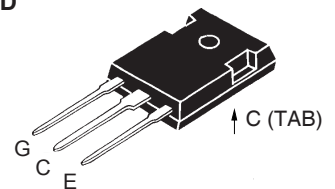


Symbol	Test Conditions	Maximum Ratings	
$V_{CES}$	$T_J = 25^\circ\text{C}$ to $150^\circ\text{C}$	600	V
$V_{CGR}$	$T_J = 25^\circ\text{C}$ to $150^\circ\text{C}$ ; $R_{GE} = 1 \text{ M}\Omega$	600	V
$V_{GES}$	Continuous	$\pm 20$	V
$V_{GEM}$	Transient	$\pm 30$	V
$I_{C25}$	$T_C = 25^\circ\text{C}$ (limited by leads)	75	A
$I_{C110}$	$T_C = 110^\circ\text{C}$	40	A
$I_{CM}$	$T_C = 25^\circ\text{C}$ , 1 ms	200	A
<b>SSOA</b> <b>(RBSOA)</b>	$V_{GE} = 15 \text{ V}$ , $T_{VJ} = 125^\circ\text{C}$ , $R_G = 10 \Omega$ Clamped inductive load @ $\leq 600 \text{ V}$	$I_{CM} = 80$	A
$P_C$	$T_C = 25^\circ\text{C}$	300	W
$T_J$		-55 ... +150	$^\circ\text{C}$
$T_{JM}$		150	$^\circ\text{C}$
$T_{stg}$		-55 ... +150	$^\circ\text{C}$
Maximum lead temperature for soldering 1.6 mm (0.062 in.) from case for 10 s		300	$^\circ\text{C}$
$M_d$	Mounting torque (M3)	1.13/10 Nm/lb.in.	
<b>Weight</b>	TO-247 AD	6	g
	TO-268 SMD	4	g

TO-268  
(IXGT)



TO-247 AD  
(IXGH)



G = Gate, C = Collector,  
E = Emitter, TAB = Collector

## Features

- Medium frequency IGBT
- Square RBSOA
- High current handling capability
- MOS Gate turn-on - drive simplicity

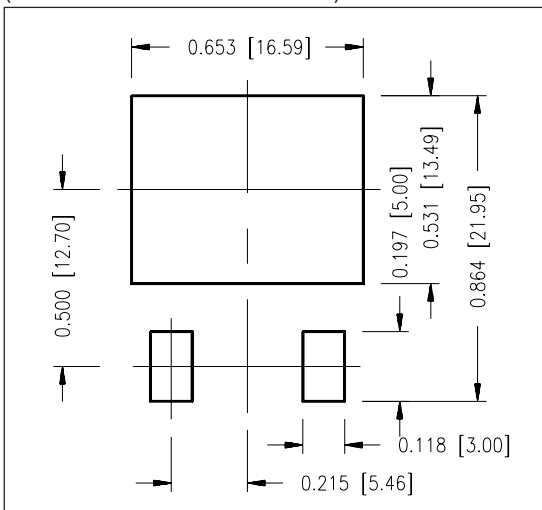
## Applications

- PFC circuits
- Uninterruptible power supplies (UPS)
- Switched-mode and resonant-mode power supplies
- AC motor speed control
- DC servo and robot drives
- DC choppers

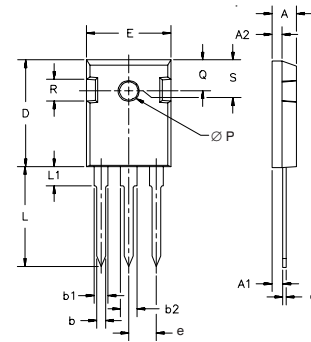
Symbol	Test Conditions	Characteristic Values ( $T_J = 25^\circ\text{C}$ , unless otherwise specified)		
		min.	typ.	max.
$V_{GE(th)}$	$I_C = 250 \mu\text{A}$ , $V_{CE} = V_{GE}$	3.0		5.0 V
$I_{CES}$	$V_{CE} = V_{CES}$ $V_{GE} = 0 \text{ V}$		$T_J = 25^\circ\text{C}$ $T_J = 150^\circ\text{C}$	50 $\mu\text{A}$ 1 mA
$I_{GES}$	$V_{CE} = 0 \text{ V}$ , $V_{GE} = \pm 20 \text{ V}$			$\pm 100 \text{ nA}$
$V_{CE(sat)}$	$I_C = 30 \text{ A}$ , $V_{GE} = 15 \text{ V}$		$T_J = 25^\circ\text{C}$	1.7 V

Symbol	Test Conditions	Characteristic Values ( $T_J = 25^\circ\text{C}$ , unless otherwise specified)			
		min.	typ.	max.	
$g_{fs}$	$I_C = 30\text{ A}; V_{CE} = 10\text{ V}$ , Pulse test, $t \leq 300\ \mu\text{s}$ , duty cycle $\leq 2\%$	20	36	S	
$C_{ies}$ $C_{oes}$ $C_{res}$	$V_{CE} = 25\text{ V}, V_{GE} = 0\text{ V}, f = 1\text{ MHz}$		2560	pF	
			180	pF	
			54	pF	
$Q_g$ $Q_{ge}$ $Q_{gc}$	$I_C = 30\text{ A}, V_{GE} = 15\text{ V}, V_{CE} = 300\text{ V}$		100	nC	
			15	nC	
			36	nC	
$t_{d(on)}$ $t_{ri}$ $t_{d(off)}$ $t_{fi}$ $E_{off}$	<b>Inductive load, <math>T_J = 25^\circ\text{C}</math></b> $I_C = 30\text{ A}, V_{GE} = 15\text{ V}$ $V_{CE} = 400\text{ V}, R_G = 3.3\ \Omega$		18	ns	
			20	ns	
			130	200	ns
			82	150	ns
			0.4	0.8	mJ
$t_{d(on)}$ $t_{ri}$ $E_{on}$ $t_{d(off)}$ $t_{fi}$ $E_{off}$	<b>Inductive load, <math>T_J = 125^\circ\text{C}</math></b> $I_C = 30\text{ A}, V_{GE} = 15\text{ V}$ $V_{CE} = 400\text{ V}, R_G = 3.3\ \Omega$		18	ns	
			20	ns	
			0.3		mJ
			240		ns
			150		ns
			1.10		mJ
$R_{thJC}$ $R_{thCK}$	(TO-247)			0.42 KW KW	
		0.25			

**Min. Recommended Footprint**  
(Dimensions in inches and mm)

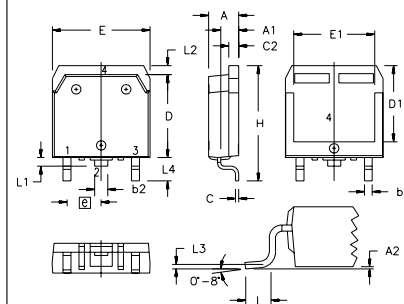


**TO-247 AD Outline**



Dim.	Millimeter		Inches	
	Min.	Max.	Min.	Max.
A	4.7	5.3	.185	.209
A <sub>1</sub>	2.2	2.54	.087	.102
A <sub>2</sub>	2.2	2.6	.059	.098
b	1.0	1.4	.040	.055
b <sub>1</sub>	1.65	2.13	.065	.084
b <sub>2</sub>	2.87	3.12	.113	.123
C	.4	.8	.016	.031
D	20.80	21.46	.819	.845
E	15.75	16.26	.610	.640
e	5.20	5.72	0.205	0.225
L	19.81	20.32	.780	.800
L <sub>1</sub>		4.50		.177
∅P	3.55	3.65	.140	.144
Q	5.89	6.40	0.232	0.252
R	4.32	5.49	.170	.216
S	6.15	BSC	.242	BSC

**TO-268 Outline**



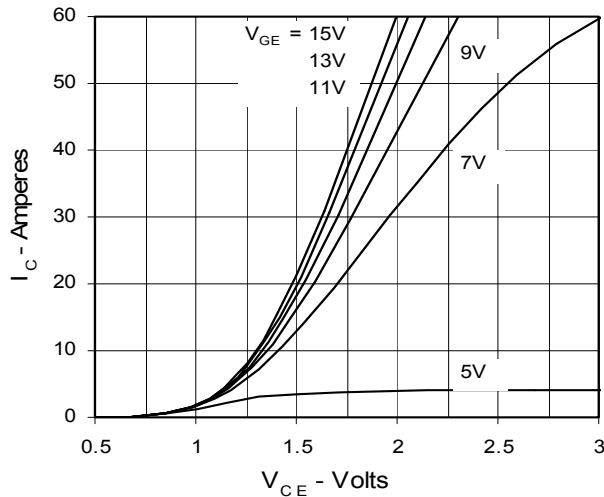
SYM	INCHES		MILLIMETERS	
	MIN	MAX	MIN	MAX
A	.193	.201	4.90	5.10
A <sub>1</sub>	.106	.114	2.70	2.90
A <sub>2</sub>	.001	.010	0.02	0.25
b	.045	.057	1.15	1.45
b <sub>2</sub>	.075	.083	1.90	2.10
C	.016	.026	0.40	0.65
C <sub>2</sub>	.057	.063	1.45	1.60
D	.543	.551	13.80	14.00
D <sub>1</sub>	.488	.500	12.40	12.70
E	.624	.632	15.85	16.05
E <sub>1</sub>	.524	.535	13.30	13.60
e	.215 BSC		5.45 BSC	
H	.736	.752	18.70	19.10
L	.094	.106	2.40	2.70
L <sub>1</sub>	.047	.055	1.20	1.40
L <sub>2</sub>	.039	.045	1.00	1.15
L <sub>3</sub>	.010 BSC		0.25 BSC	
L <sub>4</sub>	.150	.161	3.80	4.10

IXYS reserves the right to change limits, test conditions, and dimensions.

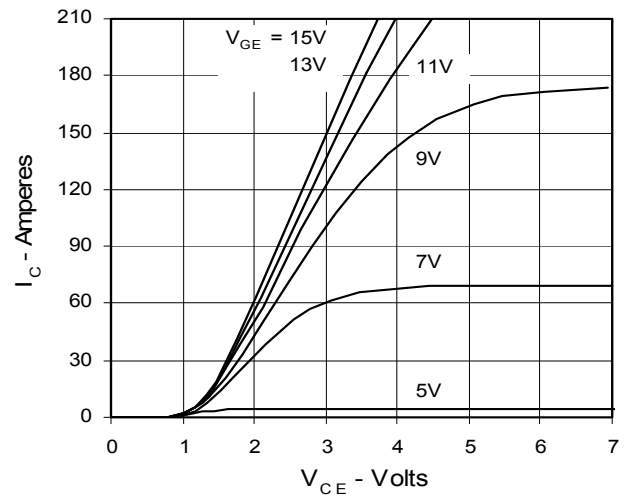
IXYS MOSFETs and IGBTs are covered by one or more of the following U.S. patents:

4,835,592 4,881,106 5,017,508 5,049,961 5,187,117 5,486,715 6,306,728B1 6,259,123B1 6,306,728B1  
4,850,072 4,931,844 5,034,796 5,063,307 5,237,481 5,381,025 6,404,065B1 6,162,665 6,534,343

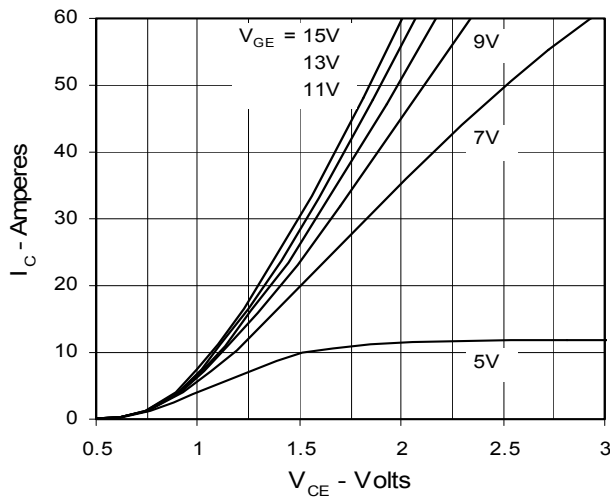
**Fig. 1. Output Characteristics @ 25 Deg. C**



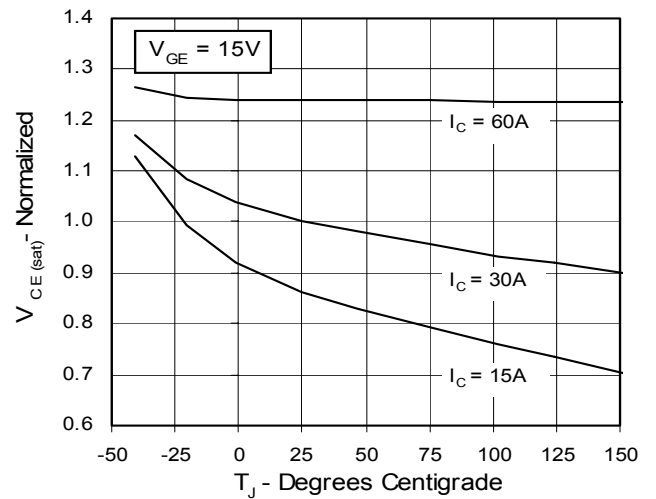
**Fig. 2. Extended Output Characteristics @ 25 deg. C**



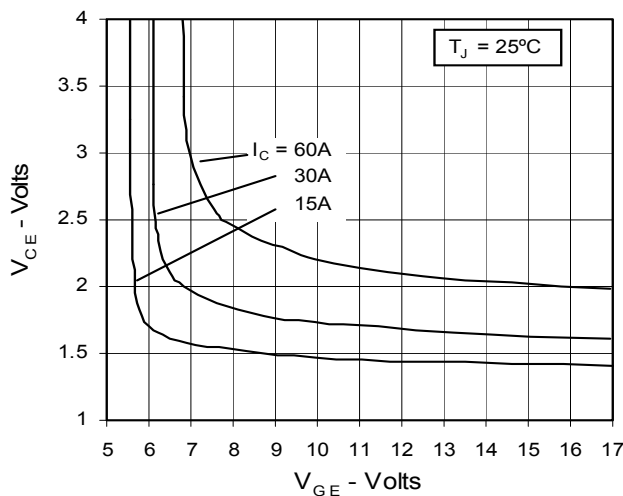
**Fig. 3. Output Characteristics @ 125 Deg. C**



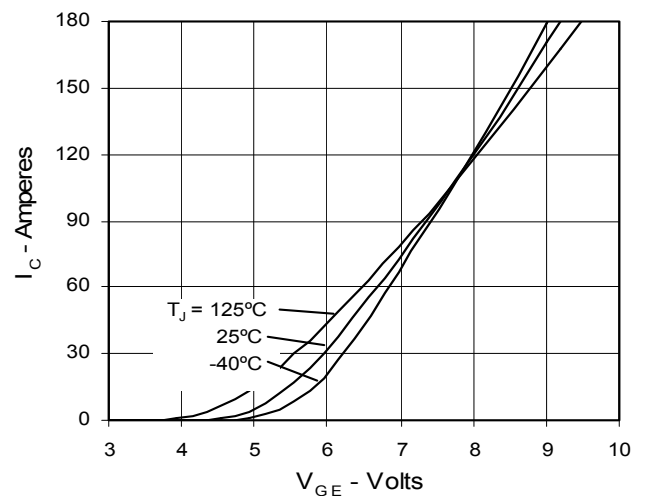
**Fig. 4. Dependence of  $V_{CE(sat)}$  on Temperature**



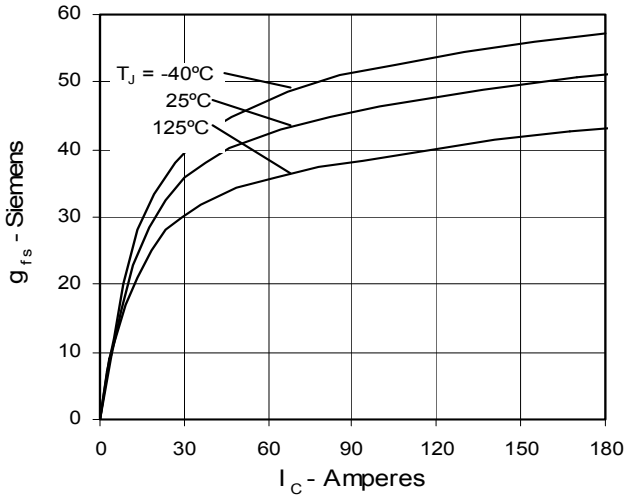
**Fig. 5. Collector-to-Emitter Voltage vs. Gate-to-Emitter voltage**



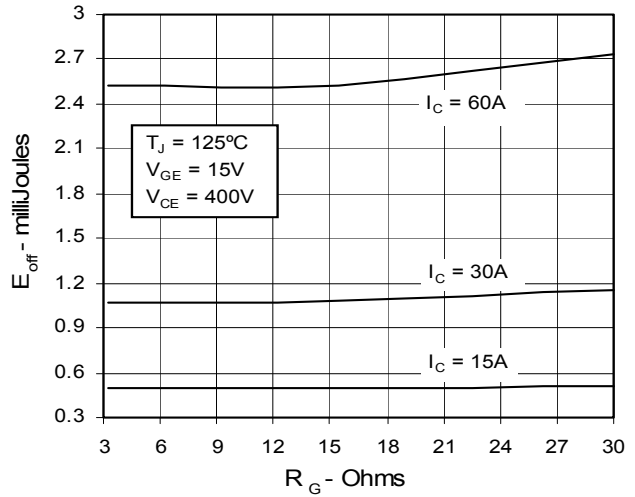
**Fig. 6. Input Admittance**



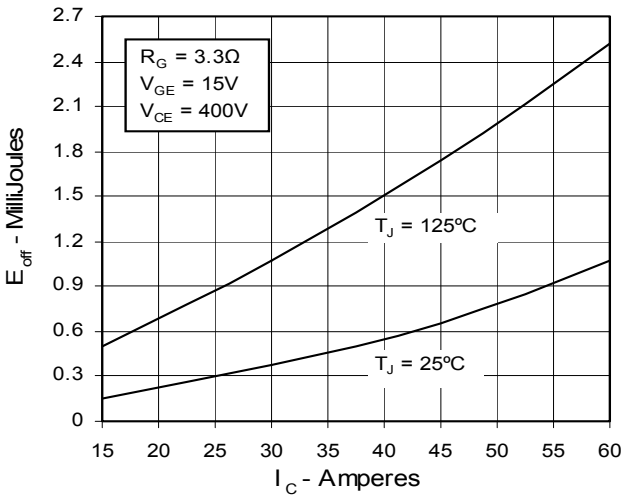
**Fig. 7. Transconductance**



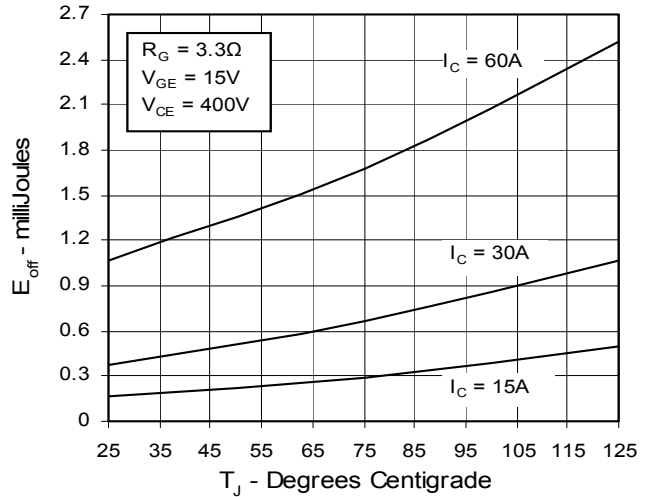
**Fig. 8. Dependence of Turn-Off Energy on  $R_G$**



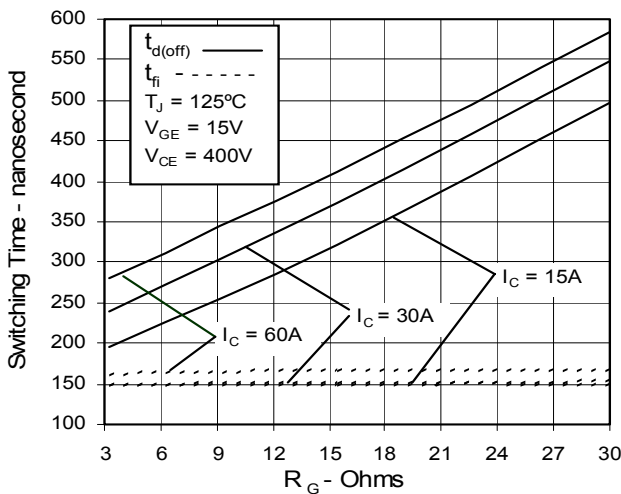
**Fig. 9. Dependence of Turn-Off Energy on  $I_C$**



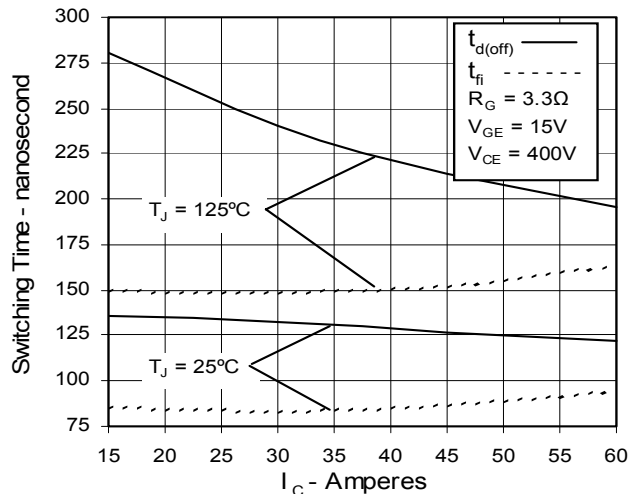
**Fig. 10. Dependence of Turn-Off Energy on Temperature**



**Fig. 11. Dependence of Turn-Off Switching Time on  $R_G$**

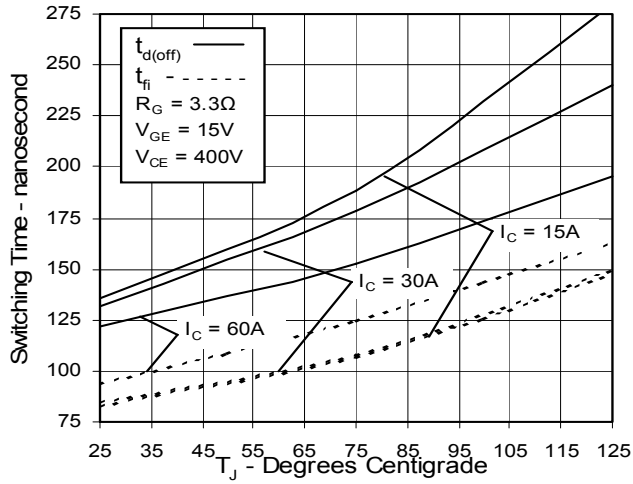


**Fig. 12. Dependence of Turn-Off Switching Time on  $I_C$**

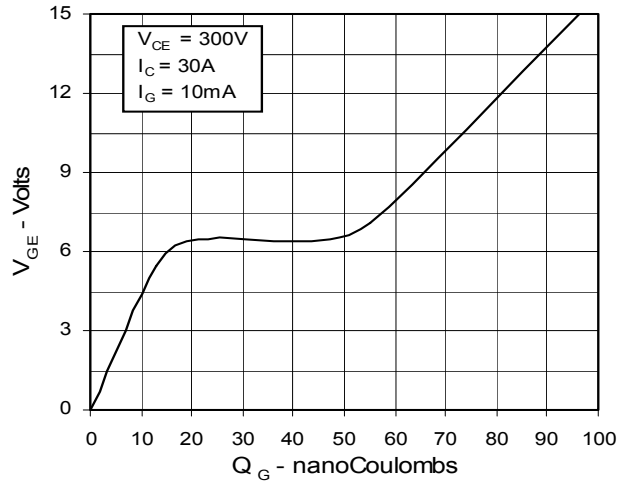


IXYS reserves the right to change limits, test conditions, and dimensions.

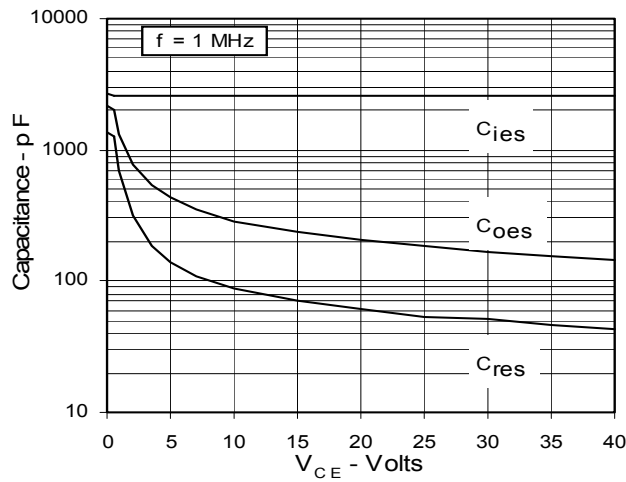
**Fig. 13. Dependence of Turn-Off Switching Time on Temperature**



**Fig. 14. Gate Charge**



**Fig. 15. Capacitance**



**Fig. 16. Maximum Transient Thermal Resistance**

