

HiPerFET™ Power MOSFETs

IXFK 20N120 IXFX 20N120

$$V_{DSS} = 1200 \text{ V}$$

$$I_{D25} = 20 \text{ A}$$

$$R_{DS(on)} = 0.75 \Omega$$

$$t_{rr} \leq 300 \text{ ns}$$

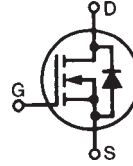

Symbol	Test Conditions	Maximum Ratings	
V_{DSS}	$T_J = 25^\circ\text{C}$ to 150°C	1200	V
V_{DGR}	$T_J = 25^\circ\text{C}$ to 150°C ; $R_{GS} = 1 \text{ M}\Omega$	1200	V
V_{GS}	Continuous	± 30	V
V_{GSM}	Transient	± 40	V
I_{D25}	$T_C = 25^\circ\text{C}$	20	A
I_{DM}	$T_C = 25^\circ\text{C}$, Note 1	80	A
I_{AR}	$T_C = 25^\circ\text{C}$	10	A
E_{AR}	$T_C = 25^\circ\text{C}$	40	mJ
E_{AS}	$T_C = 25^\circ\text{C}$	2	J
dv/dt	$I_S \leq I_{DM}$, $di/dt \leq 100 \text{ A}/\mu\text{s}$, $V_{DD} \leq V_{DSS}$ $T_J \leq 150^\circ\text{C}$, $R_G = 2 \Omega$	5	V/ns
P_D	$T_C = 25^\circ\text{C}$	780	W
T_J		-55 ... +150	$^\circ\text{C}$
T_{JM}		150	$^\circ\text{C}$
T_{stg}		-55 ... +150	$^\circ\text{C}$
T_L	1.6 mm (0.063 in.) from case for 10 s	300	$^\circ\text{C}$
M_d	Mounting torque	TO-264	0.9/6 Nm/lb.in.
Weight		PLUS 247	6 g
		TO-264	10 g

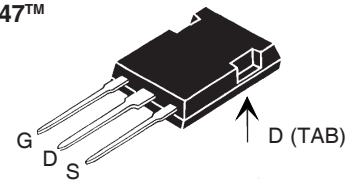
 PLUS 247™
(IXFX)

TO-264 AA (IXFK)

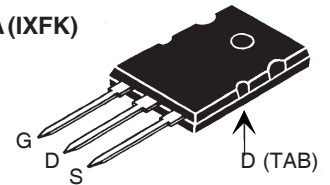
 G = Gate
S = Source

 D = Drain
TAB = Drain

Features

- International standard packages
- Low $R_{DS(on)}$ HDMOS™ process
- Rugged polysilicon gate cell structure
- Unclamped Inductive Switching (UIS) rated
- Low package inductance
 - easy to drive and to protect
- Fast intrinsic rectifier

Applications

- DC-DC converters
- Battery chargers
- Switched-mode and resonant-mode power supplies
- DC choppers
- AC motor control
- Temperature and lighting controls

Advantages

- PLUS 247™ package for clip or spring mounting
- Space savings
- High power density

Symbol	Test Conditions	Characteristic Values ($T_J = 25^\circ\text{C}$, unless otherwise specified)		
		min.	typ.	max.
V_{DSS}	$V_{GS} = 0 \text{ V}$, $I_D = 1 \text{ mA}$	1200		V
$V_{GS(th)}$	$V_{DS} = V_{GS}$, $I_D = 8 \text{ mA}$	2.5		4.5 V
I_{GSS}	$V_{GS} = \pm 30 \text{ V}$, $V_{DS} = 0$			$\pm 100 \text{ nA}$
I_{DSS}	$V_{DS} = V_{DSS}$ $V_{GS} = 0 \text{ V}$	$T_J = 25^\circ\text{C}$ $T_J = 125^\circ\text{C}$		100 μA 2 mA
$R_{DS(on)}$	$V_{GS} = 10 \text{ V}$, $I_D = 0.5 \cdot I_{D25}$ Note 2			0.75 Ω

Symbol	Test Conditions	Characteristic Values			S
		$(T_J = 25^\circ\text{C}, \text{ unless otherwise specified})$			
		min.	typ.	max.	
g_{fs}	$V_{DS} = 10\text{ V}; I_D = 0.5 \cdot I_{D25}$ Note 2	15	27		
C_{iss}	$V_{GS} = 0\text{ V}, V_{DS} = 25\text{ V}, f = 1\text{ MHz}$		7400		pF
C_{oss}			550		pF
C_{rss}			100		pF
$t_{d(on)}$	$V_{GS} = 10\text{ V}, V_{DS} = 0.5 \cdot V_{DSS}, I_D = 0.5 \cdot I_{D25}$ $R_G = 1\ \Omega$ (External),		25		ns
t_r			45		ns
$t_{d(off)}$			75		ns
t_f			20		ns
$Q_{g(on)}$	$V_{GS} = 10\text{ V}, V_{DS} = 0.5 \cdot V_{DSS}, I_D = 0.5 \cdot I_{D25}$		160		nC
Q_{gs}			35		nC
Q_{gd}			60		nC
R_{thJC}				0.16	K/W
R_{thCK}			0.15		K/W

Symbol	Test Conditions	Characteristic Values			A
		$(T_J = 25^\circ\text{C}, \text{ unless otherwise specified})$			
		min.	typ.	max.	
I_s	$V_{GS} = 0\text{ V}$			20	A
I_{SM}	Repetitive; pulse width limited by T_{JM}			80	A
V_{SD}	$I_F = I_s, V_{GS} = 0\text{ V}, \text{ Note 1}$			1.5	V
t_{rr}	$I_F = I_s, -di/dt = 100\text{ A}/\mu\text{s}, V_R = 100\text{ V}$			300	ns
Q_{RM}			1.4		μC
I_{RM}			8		A

Note: 1. Pulse width limited by T_{JM}
 2. Pulse test, $t \leq 300\ \mu\text{s}$, duty cycle $d \leq 2\%$

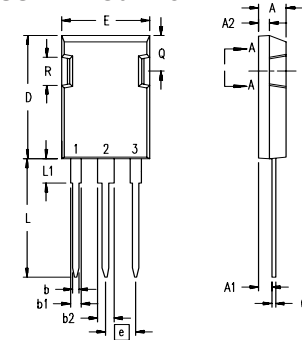
PLUS247™ Outline

Terminals: 1 - Gate
 2 - Drain (Collector)
 3 - Source (Emitter)
 4 - Drain (Collector)

Dim.	Millimeter		Inches	
	Min.	Max.	Min.	Max.
A	4.83	5.21	.190	.205
A ₁	2.29	2.54	.090	.100
A ₂	1.91	2.16	.075	.085
b	1.14	1.40	.045	.055
b ₁	1.91	2.13	.075	.084
b ₂	2.92	3.12	.115	.123
C	0.61	0.80	.024	.031
D	20.80	21.34	.819	.840
E	15.75	16.13	.620	.635
e	5.45 BSC		.215 BSC	
L	19.81	20.32	.780	.800
L1	3.81	4.32	.150	.170
Q	5.59	6.20	.220	0.244
R	4.32	4.83	.170	.190

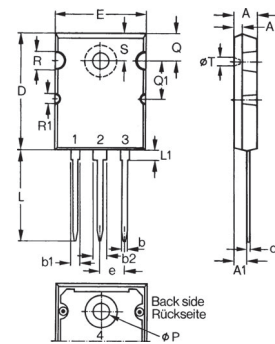
TO-264 AA Outline

Dim.	Millimeter		Inches	
	Min.	Max.	Min.	Max.
A	4.82	5.13	.190	.202
A ₁	2.54	2.89	.100	.114
A ₂	2.00	2.10	.079	.083
b	1.12	1.42	.044	.056
b ₁	2.39	2.69	.094	.106
b ₂	2.90	3.09	.114	.122
c	0.53	0.83	.021	.033
D	25.91	26.16	1.020	1.030
E	19.81	19.96	.780	.786
e	5.46 BSC		.215 BSC	
J	0.00	0.25	.000	.010
K	0.00	0.25	.000	.010
L	20.32	20.83	.800	.820
L1	2.29	2.59	.090	.102
P	3.17	3.66	.125	.144
Q	6.07	6.27	.239	.247
Q1	8.38	8.69	.330	.342
R	3.81	4.32	.150	.170
R1	1.78	2.29	.070	.090
S	6.04	6.30	.238	.248
T	1.57	1.83	.062	.072

IXYS reserves the right to change limits, test conditions, and dimensions.

Fig. 1. Output Characteristics @ 25 deg. C

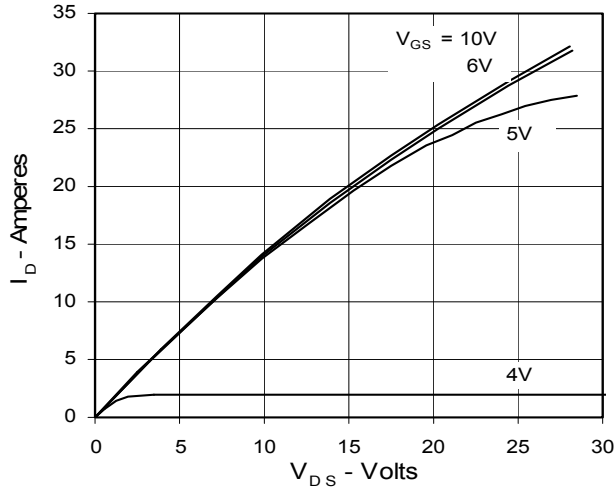

Fig. 2. Output Characteristics @ 125 Deg. C

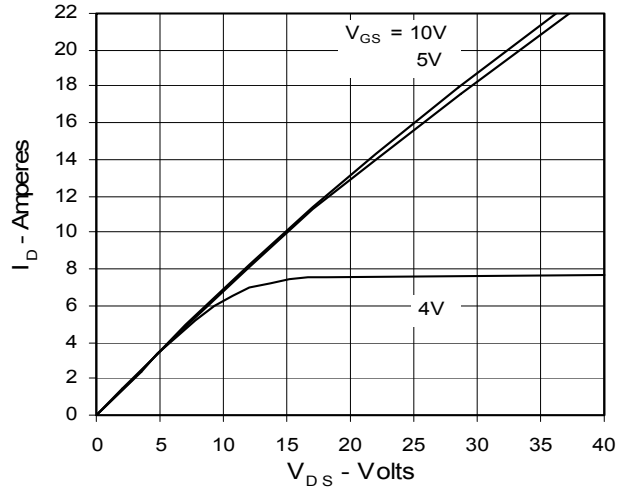

Fig. 3. $R_{DS(on)}$ Normalized to I_{D25} Value vs. Junction Temperature

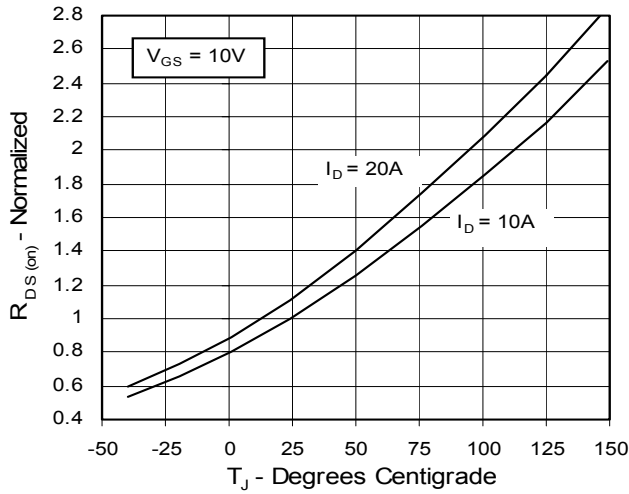

Fig. 4. $R_{DS(on)}$ Normalized to I_{D25} Value vs. I_D

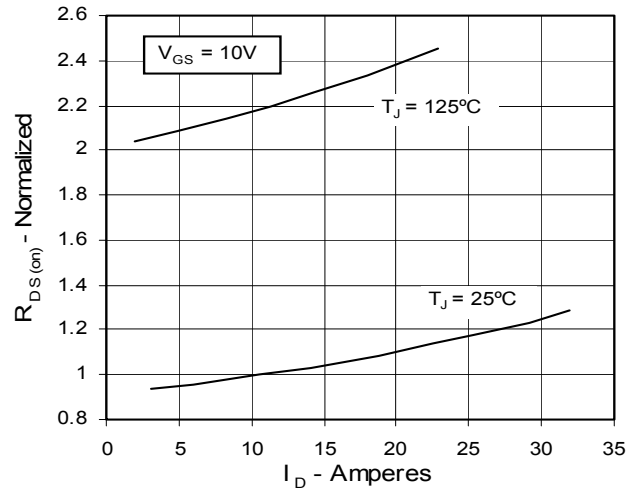

Fig. 5. Drain Current vs. Case Temperature

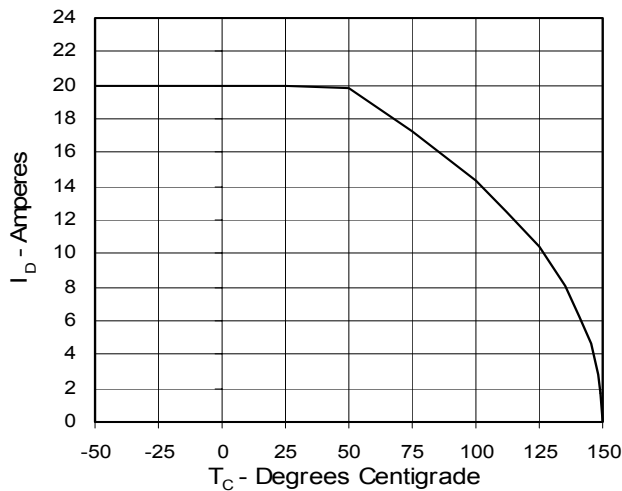

Fig. 6. Input Admittance

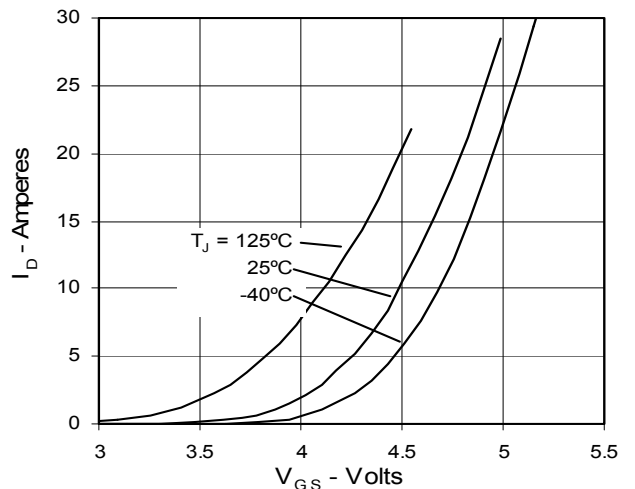

Fig. 7. Transconductance

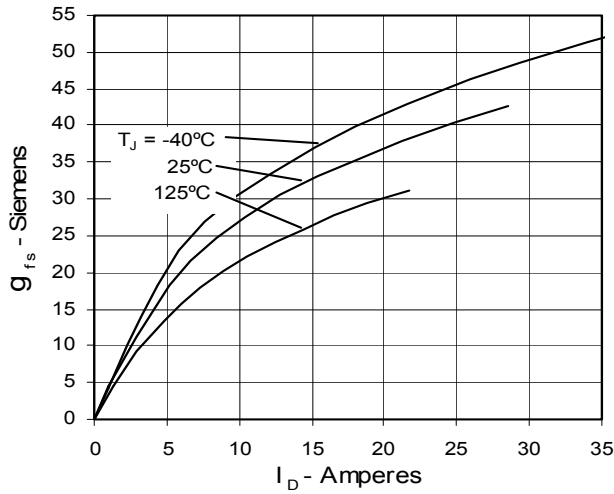

Fig. 8. Source Current vs. Source-To-Drain Voltage

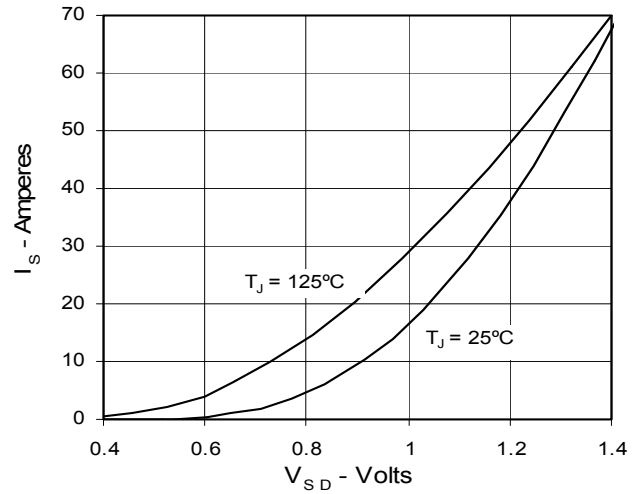

Fig. 9. Gate Charge

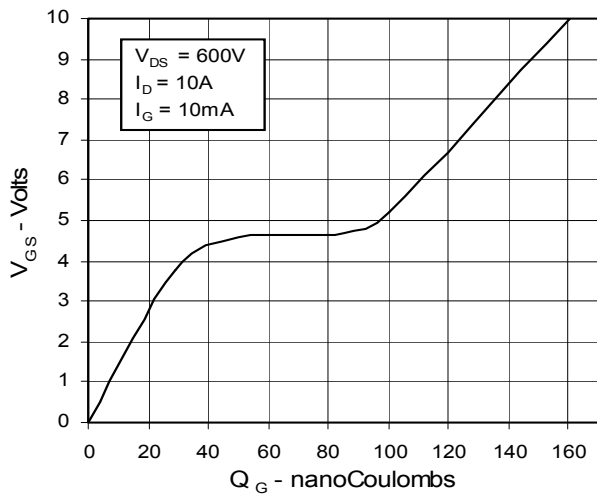

Fig. 10. Capacitance

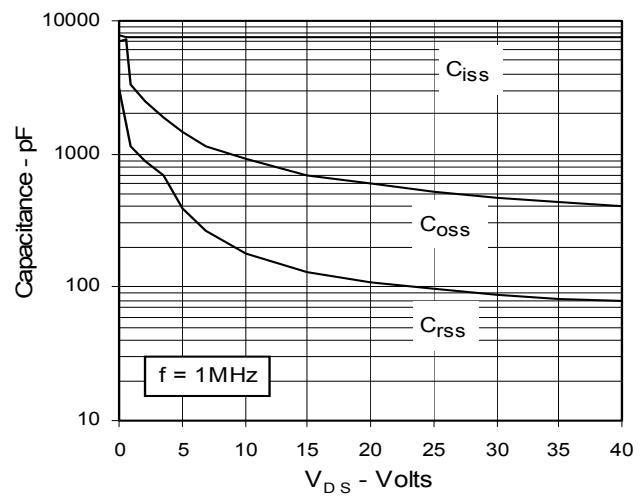

Fig. 11. Maximum Transient Thermal Resistance

