



ATTENTION
OBSERVE PRECAUTIONS
FOR HANDLING
ELECTROSTATIC
DISCHARGE
SENSITIVE
DEVICES

Part No./型号: 530LB5C

➤ Features/特征:

- Single color/单色
- High bright output/高亮度输出
- Low power consumption/低功耗
- High reliability and long life/
可靠性高、寿命长

➤ Descriptions/描述:

- Dice material/芯片材质: InGaN
- Emitting Color/发光颜色:
Super Bright Blue/ 高亮度蓝色
- Device Outline/产品外形:
φ 5mm Round Type/ 5mm 圆形
- Lens Type 胶体颜色:
Water Clear/ 无色透明

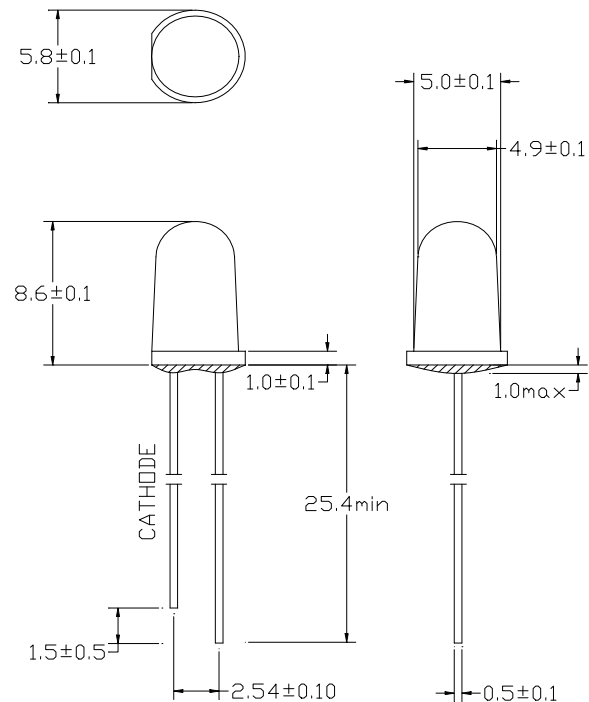

1. All dimensions are millimeters/单位: mm.
2. Tolerance is +/-0.25mm unless otherwise noted/
没有标注的公差均为±0.25mm.

➤ Directivity/指向特性:

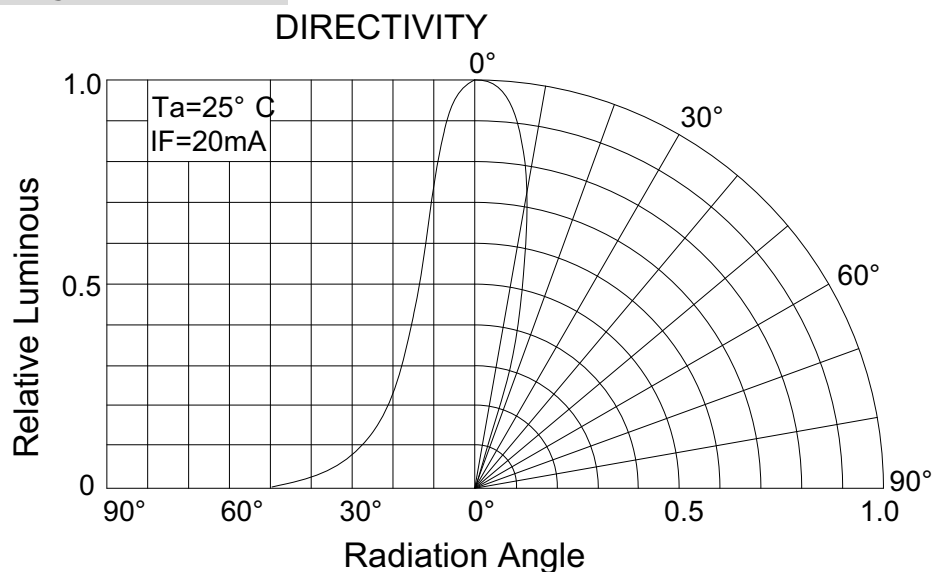

➤ **Absolute maximum ratings/极限参数 (Ta = 25°C)**

Parameter 参数	Symbol 符号	Test Condition 测试条件	Values 数值		Unit 单位
			Min.	Max.	
Reverse Voltage 反向电压	V _R	I _R = 30 μA	5	--	V
Forward Current 正向工作电流	I _F	----	----	25	mA
Power Dissipation 损耗功率	P _d	----	----	90	mW
Pulse Current 正向峰值电流	I _{peak}	Duty=0.1mS, 1kHz	----	100	mA
Operating Temperature 工作温度范围	T _{opr}	----	-40	+85	°C
Storage Temperature 储存温度范围	T _{str}	----	-40	+100	°C

➤ **Electrical and optical characteristics/光电参数 (Ta = 25°C)**

Parameter 参数	Symbol 符号	Test Condition 测试条件	Values 数值			Unit 单位
			Min.	Typ.	Max.	
Forward Voltage 正向电压	V _F	I _F =20mA	----	3.2	3.6	V
Reverse Current 反向电流	I _R	V _R =5V	----	----	30	μA
Dominate Wavelength 主波长	λ _d	I _F =20mA	----	455	----	nm
Peak Wavelength 峰值波长	λ _p	I _F =20mA	----	457	----	nm
Spectral Line half-width 半波长宽度	Δλ	I _F =20mA	----	20	----	nm
Luminous Intensity 发光强度	I _v	I _F =20mA	----	800	----	mcd
Viewing Angle 指向角度	2θ _{1/2}	I _F =20mA	----	36	----	deg.

➤ **Typical electrical/optical characteristic curves/光电特性曲线:**

Fig.1 正向电流 Vs. 正向电压

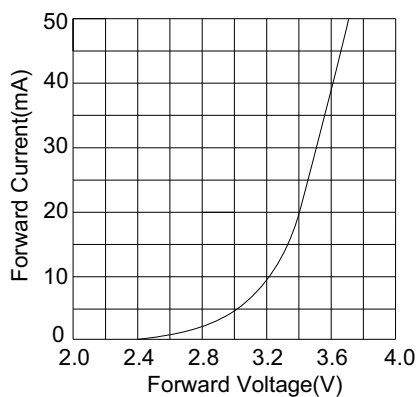

Fig.2 相对亮度 Vs. 正向电流

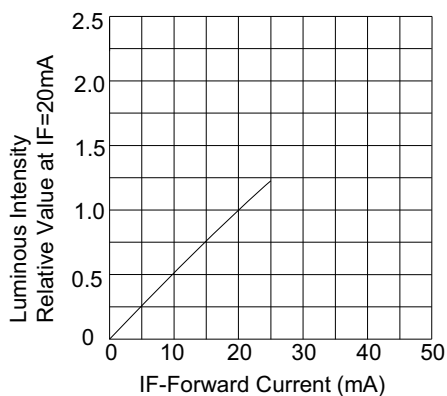

Fig.3 正向电流 Vs. 环境温度

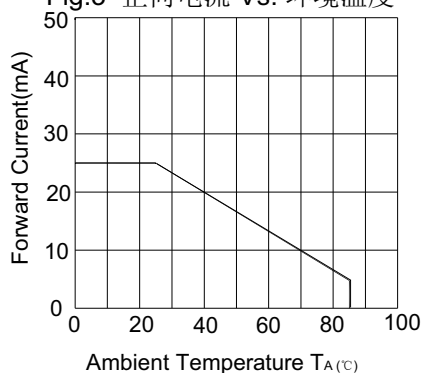

Fig.4 相对亮度 Vs. 环境温度

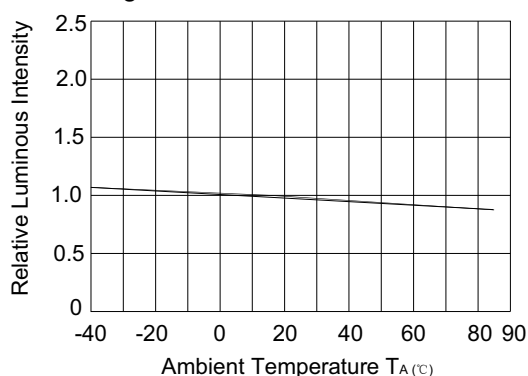
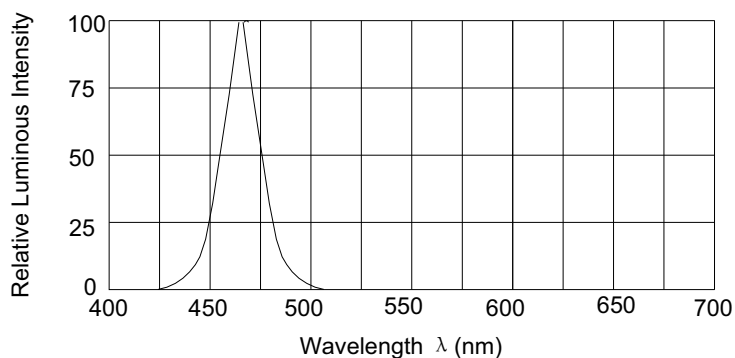

Fig.5 相对亮度 Vs. 波长





BIN ranking for LEDs

BRIGHTNESS BIN

Bin Code	IV(mcd)	Bin Code	IV(mcd)	Bin Code	IV(mcd)	Bin Code	IV(mcd)
A	0-5.0	H	37.2-52.0	Q	390-550	X	4180--5860
B	5.0-7.0	J	52.0-72.8	R	550-770	Y	5860-8200
C	7.0-9.8	K	72.8-102	S	770-1100	Z1	8-10cd
D	9.8-13.7	L	102-145	T	1100-1520	Z2	10-12cd
E	13.7-19.0	M	145-200	U	1520-2130	Z3	12-14cd
F	19.0-26.6	N	200-280	V	2130-3000	Z4	14-16cd
G	26.6-37.2	P	280-390	W	3000-4180	Z5	16-18cd

WAVELENGTH BIN

Ligth Col.	Bin Code	Wavel. (nm)	Ligth Col.	Bin Code	Wavel. (nm)	
BLUE	B1	450-455	YELLOW GREEN	YG1	555-558	
	B2	455-460		YG2	558-561	
	B3	460-465		YG3	561-564	
	B4	465-470		YG4	564-567	
	B5	470-475		YG5	567-570	
	B6	475-480		YG6	570-573	
BLUE GREEN	G1	491-494		YG7	573-576	
	G2	494-497	YELLOW	Y1	582-585	
	G3	497-500		Y2	585-588	
	G4	500-503		Y3	588-591	
	G5	503-506		Y4	591-594	
	G6	506-509		Y5	594-597	
	PURE GREEN	G7	509-512	YELLOW ORANGE	YO1	597-600
		G8	512-515		YO2	600-603
G9		515-518	PURE ORANGE	YO3	603-606	
G10		518-521		YO4	606-609	
G11		521-524		RED	O1	609-612
G12		524-527	O2		612-615	
G13		527-530	O3		615-618	
G14		530-533	R1		618-621	
G15		533-536	R2		621-624	
G16		536-539	R3		624-627	
G17		539-542	R4	627-630		
G18		542-545	R5	630-633		
G19		545-548	R6	633-636		

FORWARD VOLTAGE (VF) BIN

Bin Code	VF (V)	Bin Code	VF (V)	Bin Code	VF (V)	Bin Code	VF (V)
V1	1.6-1.8	V5	2.4-2.6	V9	3.2-3.4	V13	4.0-4.2
V2	1.8-2.0	V6	2.6-2.8	V10	3.4-3.6	V14	4.2-4.4
V3	2.0-2.2	V7	2.8-3.0	V11	3.6-3.8	V15	4.4-4.6
V4	2.2-2.4	V8	3.0-3.2	V12	3.8-4.0	V16	4.6-4.8



LED LAMP APPLICATION

•SOLDERING

METHOD	SOLDERING CONDITIONS	REMARK
DIP SOLDERING	Bath temperature: $260 \pm 5^\circ\text{C}$ Immersion time: with 5 sec	<ul style="list-style-type: none"> Solder no closer than 3mm from the base of the package Using soldering flux, "RESIN FLUX" is recommended.
SOLDERING IRON	Soldering iron: 30W or smaller Temperature at tip of iron: 260°C or lower Soldering time: within 5 sec.	<ul style="list-style-type: none"> During soldering, take care not to press the tip of iron against the lead. (To prevent heat from being transferred directly to the lead, hold the lead with a pair of tweezers while soldering)

1) When soldering the lead of LED in a condition that the package is fixed with a panel (See Fig.1), be careful not to stress the leads with iron tip.

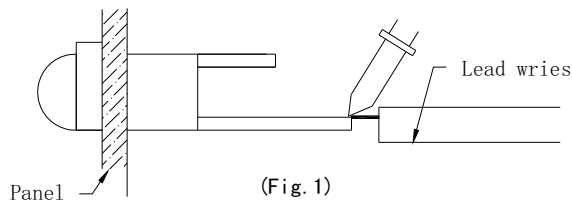

2) When soldering wire to the lead, work with a Fig (See Fig.2) to avoid stressing the package.

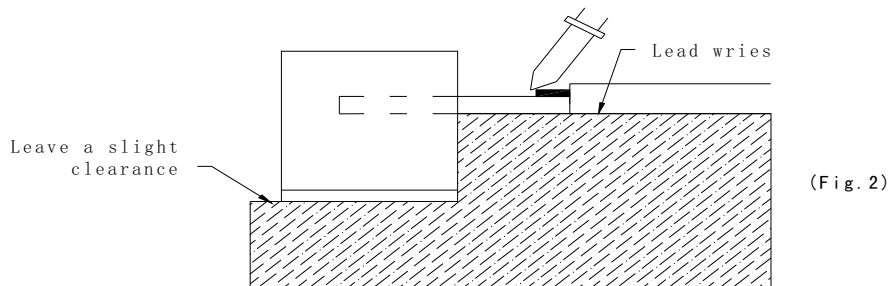

- 3) Similarly, when a jig is used to solder the LED to PC board, take care as much as possible to avoid steering the leads (See Fig.3).

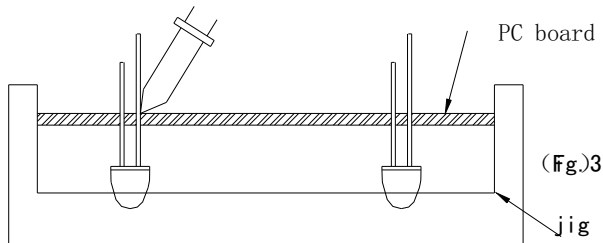

- 4) Repositioning after soldering should be avoided as much as possible. If inevitable, be sure to preserve the soldering conditions with irons stated above: select a best-suited method that assures the least stress to the LED.
- 5) Lead cutting after soldering should be performed only after the LED temperature has returned to normal temperature.

•LED MOUNTING METHOD

- 1) When mounting the LED by using a case, as shown Fig.4, ensure that the mounting holds on the PC board match the pitch of the leads correctly-tolerance of dimensions of the respective components including the LED should be taken into account especially when designing the case, PC board, etc. to prevent pitch misalignment between the leads and board holes, the diameter of the board holes should be slightly larger than the size of the lead. Alternatively, the shape of the holes should be made oval. (See Fig.4)

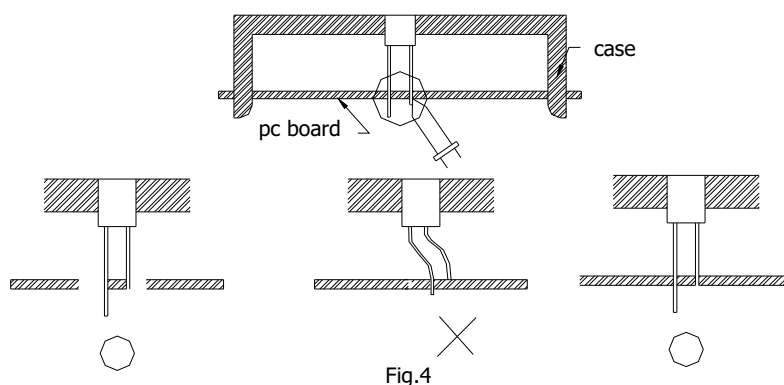



LED LAMP APPLICATION

2) Use LEDs with stand-off (Fig.5) or the tube or spacer made of resin (Fig.6) to position the LEDs.

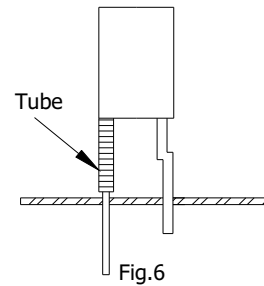
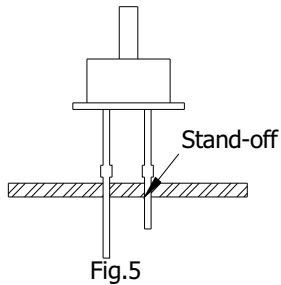

•FORMED LEAD

1) The lead should be bent at a point located at least 2mm away from the package. Bending should be performed with base fixed means of a jig or pliers (Fig.7)

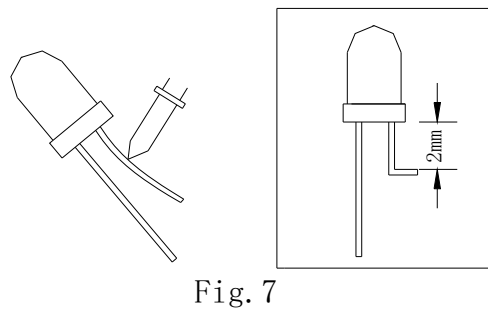

2) Forming lead should be carried out prior to soldering and never during or after soldering.
3) Form the lead to ensure alignment between the leads and the hole on board, so that stress against the LED is prevented. (Fig.8)

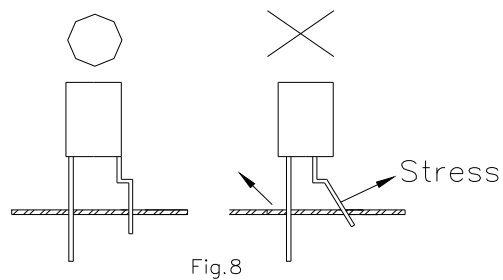



•LEAD STRENGTH

1) Bend strength

Do not bend the lead more than twice. (Fig.9)

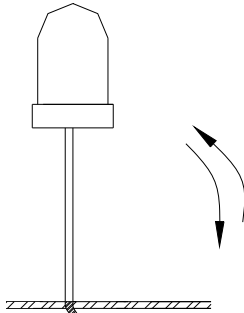

Fig.9

2) Tensile strength (@Room Temperature)

If the force is 1kg or less, there will be no problem. (Fig.10)

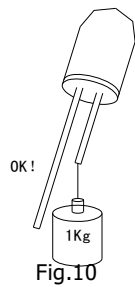

Fig.10

•HANDLING PRECAUTIONS

Although rigid against vibration, the LEDs may damaged or scratched if dropped. So take care when handling.

•CHEMICAL RESISTANCE

- 1) Avoid exposure to chemicals as it may attack the LED surface and cause discoloration.
- 2) When washing is required, refer to the following table for the proper chemical to be sued. (Immersion time: within 3 minutes at room temperature.)

SOLVENT	ADAPTABILITY
Freon TE	⊙
Chlorothene	×
Isopropyl Alcohol	⊙
Thinner	×
Acetone	×
Trichloroethylene	×

⊙--Usable ×--Do not use.

NOTE: Influences of ultrasonic cleaning of the LED resin body differ depending on such factors as the oscillator output, size of the PC board and the way in which the LED is mounted. Therefore, ultrasonic cleaning should only be performed after confirming there is no problem by conducting a test under practical.



LED LAMP PASSED TESTS

Experiment Item:

Item	Test Condition	Reference Standard
	Lamp & IR	
OPERATION LIFE	$T_a : 25 \pm 5^\circ\text{C}$ $I_F = 20\text{mA}$ RH : $\leq 60\% \text{RH}$ ① DYNAMIC: 100mA 1ms 1/10 duty ② STATIC STATE: $I_F = 20\text{mA}$ TEST TIME: 168HRS (-24HRS , +24HRS) 500HRS (-24HRS , +24HRS) 1000HRS (-24HRS , +72HRS)	MIL-STD-750 : 1026 MIL-STD-883 : 1005 JIS C 7021 : B-1
HIGH TEMPERATURE HIGH HUMIDITY STORAGE	$T_a : 65^\circ\text{C} \pm 5^\circ\text{C}$ RH : 90~95%RH TEST TIME : 240HRS \pm 2HRS	MIL-STD-202 : 103B JIS C 7021 : B-1
TEMPERATURE CYCLING	$105^\circ\text{C} \sim 25^\circ\text{C} \sim -55^\circ\text{C} \sim 25^\circ\text{C}$ 30min 5min 30min 5min 10CYCLES	MIL-STD-202 : 107D MIL-STD-750 : 1051 MIL-STD-883 : 1010 JIS C 7021 : A-4
THERMAL SHOCK	$105^\circ\text{C} \pm 5^\circ\text{C} \sim -55^\circ\text{C} \pm 5^\circ\text{C}$ 10min 10min 10CYCLES	MIL-STD-202 : 107D MIL-STD-750 : 1051 MIL-SYD-883 : 1011
SOLDER RESISTANCE	$T, \text{sol} : 260^\circ\text{C} \pm 5^\circ\text{C}$ DWELL TIME : 10 \pm 1sec	MIL-STD-202 : 210A MIL-STD-750-2031 JIS C 7021 : A-1
SOLDERABILITY	$T, \text{sol} : 230^\circ\text{C} \pm 5^\circ\text{C}$ DWELL TIME : 5 \pm 1sec	MIL-STD-202 : 208D MIL-STD-750 : 2026 MIL-STD-883 : 2003 JIS C 7021 : A-2

Drive Method

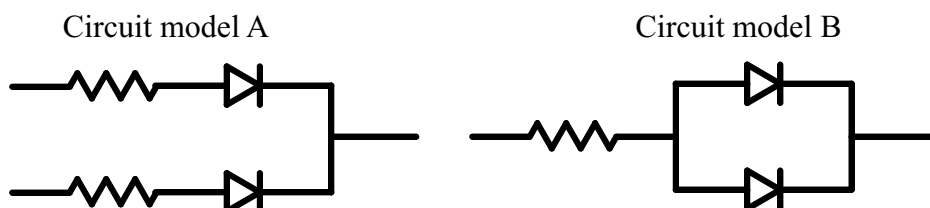

(A) Recommended circuit.

(B) The difference of brightness between LED's could be found due to the V_f - I_f characteristics of LED.