



Low-Voltage, Internal Switch, Step-Down Regulator

MAX17083

General Description

The MAX17083 is a fixed-frequency, current-mode, step-down regulator optimized for low-voltage, low-power applications. This regulator features dual internal n-channel MOSFET power switches for high efficiency and reduced component count. External Schottky diodes are not required. An integrated boost switch eliminates the need for an external boost diode. The internal 25mΩ low-side power MOSFET easily supports continuous load currents up to 5A. The MAX17083 produces an adjustable 0.75V to 2.7V output voltage from the system's 3.3V or 5V input supply.

This step-down regulator uses a peak current-mode control scheme to eliminate the additional external compensation required by voltage-mode architectures, providing an easy-to-implement architecture without sacrificing fast transient response. The MAX17083 provides peak current-limit protection and operates in light-load pulse-skipping mode to maintain high efficiency under light-load conditions.

Independent enable input and open-drain power-good output allow flexible system power sequencing. The voltage soft-start gradually ramps up the output voltage within a predictable time period, effectively limiting the inrush current. The MAX17083 features output undervoltage, output overvoltage, and thermal-fault protection.

The MAX17083 is available in a 24-pin 4mm x 4mm x 0.75mm TQFN package. The exposed backside pad improves thermal characteristics.

Features

- ◆ Fixed-Frequency, Current-Mode Controller
- ◆ 2.4V to 5.5V Input Range
- ◆ Internal 5A Step-Down Regulator
- ◆ Internal BST Switch
- ◆ Fault Protection: Undervoltage, Overvoltage, Thermal, Peak Current Limit
- ◆ Enable Input and Power-Good Output
- ◆ Voltage-Controlled Soft-Start
- ◆ High-Impedance Shutdown
- ◆ < 1μA (typ) Shutdown Current

Applications

Low-Power Architectures
 Ultra-Mobile PCs
 Netbook and Nettop PCs
 Portable Gaming
 Notebook and Subnotebook Computers
 PDAs and Mobile Communicators

Ordering Information

PART	TEMP RANGE	PIN-PACKAGE
MAX17083ETG+	-40°C to +85°C	24 TQFN

+ Denotes a lead(Pb)-free/RoHS-compliant package.

Pin Configuration

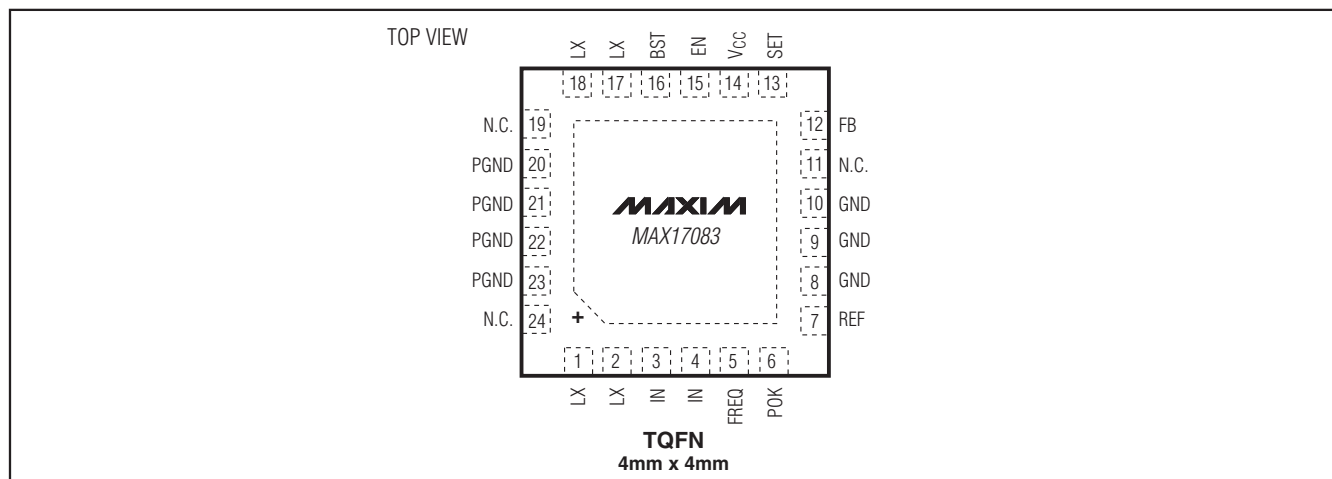

Low-Voltage, Internal Switch, Step-Down Regulator

ABSOLUTE MAXIMUM RATINGS

IN to PGND	-0.3V to +6V
V _{CC} to GND	-0.3V to +6V
EN to GND	-0.3V to +6V
REF, FB, SET, FREQ, POK to GND	-0.3V to (V _{CC} + 0.3V)
LX to GND (Notes 1, 2)	-0.6V to (V _{IN} + 0.3V)
BST to GND	(V _{CC} - 0.3V) to (V _{LX} + 6V)
GND to PGND (Note 2)	-0.3V to +0.3V
REF Short-Circuit Current	1mA

Continuous Power Dissipation, Multilayer PCB (T _A = +70°C) 24-Pin, 4mm x 4mm TQFN (derate 27.8mW/°C above +70°C)	2222mW
Operating Temperature Range	-40°C to +85°C
Junction Temperature	+150°C
Storage Temperature Range	-65°C to +150°C
Lead Temperature (soldering, 10s)	+300°C

Note 1: LX has clamp diodes to PGND and IN. If continuous current is applied through these diodes, thermal limits must be observed.

Note 2: Measurements valid using 20MHz bandwidth limit.

Stresses beyond those listed under "Absolute Maximum Ratings" may cause permanent damage to the device. These are stress ratings only, and functional operation of the device at these or any other conditions beyond those indicated in the operational sections of the specifications is not implied. Exposure to absolute maximum rating conditions for extended periods may affect device reliability.

ELECTRICAL CHARACTERISTICS

(Circuit of Figure 1, V_{IN} = V_{FREQ} = V_{CC} = V_{EN} = 5V, I_{REF} = no load, T_A = 0°C to +85°C, unless otherwise noted. Typical values are at T_A = +25°C.)

PARAMETER	SYMBOL	CONDITIONS	MIN	TYP	MAX	UNITS	
IN Input Voltage Range	V _{IN}		2.4		5.5	V	
V _{CC} Input Voltage Range	V _{CC}		4.5		5.5	V	
IN Undervoltage Threshold		No hysteresis		2.1	2.4	V	
V _{CC} Undervoltage Threshold		Rising edge, 160mV hysteresis		4.2	4.5	V	
Shutdown Supply Current		EN = GND, measured at V _{CC} , T _A = +25°C		0.1	1.0	μA	
Supply Current		Regulator enabled		65	95	μA	
REFERENCE							
Reference Output Voltage	V _{REF}	No load	1.24	1.25	1.26	V	
Reference Load Regulation		-1μA < I _{REF} < +50μA		3	10	mV	
OSCILLATOR							
Oscillator Frequency	f _{OSC}	FREQ = GND	0.45	0.50	0.55	MHz	
FREQ Settings		FREQ = V _{CC}		1.50		MHz	
		FREQ = open		1.00			
		FREQ = REF		0.75			
		FREQ = GND		0.50			
INTERNAL 5A STEP-DOWN CONVERTER							
FB Regulation Voltage (No Load)	V _{FB}	No load	SET = GND	0.754	0.765	0.774	V
			SET = REF	1.107	1.122	1.136	
			SET = open	1.51	1.53	1.55	
			SET = 5V	1.812	1.836	1.86	
FB Regulation Voltage (Full Load)	V _{FB}	I _{OUT} = 4A	SET = GND	0.72		0.774	V
			SET = REF	1.07		1.136	
			SET = open	1.45		1.55	
			SET = 5V	1.76		1.86	

Low-Voltage, Internal Switch, Step-Down Regulator

MAX17083

ELECTRICAL CHARACTERISTICS (continued)

(Circuit of Figure 1, $V_{IN} = V_{FREQ} = V_{CC} = V_{EN} = 5V$, $I_{REF} = \text{no load}$, $T_A = 0^\circ\text{C to } +85^\circ\text{C}$, unless otherwise noted. Typical values are at $T_A = +25^\circ\text{C}$.)

PARAMETER	SYMBOL	CONDITIONS	MIN	TYP	MAX	UNITS
FB Load Regulation		SET = GND		-4		mV/A
FB Line Regulation (Slope Compensation)	ΔV_{FB}	SET = GND, 0 to 100% duty cycle, $V_{CC} = 4.5V \text{ to } 5.5V$	10	15	20	mV
FB Input Current	I_{FB}	SET = GND, $T_A = +25^\circ\text{C}$	-100	-5	+100	nA
Internal MOSFET On-Resistance (Note 3)		High-side n-channel R_{DH}		32	50	m Ω
		Low-side n-channel R_{DL}		17	30	
Internal BST On-Resistance				2		Ω
LX Peak Current Limit			5	6	8	A
LX Idle Mode™ Trip Level				1.5		A
LX Zero-Crossing Trip Level				100		mA
Soft-Start Ramp Time		T_{SS}		1939/ fsw		ms
Soft-Start Fault Blanking Time		T_{SSLT}		3232/ fsw		ms
POK Upper Trip Threshold and Overvoltage Fault Threshold		Rising edge, 50mV hysteresis	9	12	14	%
POK Lower Trip Threshold		Falling edge, 50mV hysteresis	-14	-12	-9	%
POK Propagation Delay Time	t_{POK}	FB forced 50mV beyond POK trip threshold		5		μs
Overvoltage Fault Latch Delay Time		FB forced 50mV above POK upper trip threshold		5		μs
Undervoltage Fault Latch Delay Time		FB forced 50mV below POK lower trip threshold, TUV		1534/ fsw		ms
POK Output Low Voltage		$I_{SINK} = 3\text{mA}$			0.4	V
POK Leakage Current	I_{POK}	SET = GND, FB = 1V (POK high impedance), POK forced to 5.5V, $T_A = +25^\circ\text{C}$			1	μA
Thermal-Shutdown Threshold	T_{SHDN}	Hysteresis = 15°C		+160		$^\circ\text{C}$
LOGIC INPUTS						
EN Input High Threshold		Rising, hysteresis = 220mV (typ)	1.0	1.4	1.6	V
EN Input Bias Current		$T_A = +25^\circ\text{C}$		0.1	1	μA
FREQ and SET Input Voltage Levels		V_{CC}	$V_{CC} - 0.5$			V
		Open	3		3.2	
		REF	1.2		2.2	
		GND			0.5	
FREQ and SET Input Bias Currents		$T_A = +25^\circ\text{C}$	-2	+0.1	+2	μA

Idle Mode is a trademark of Maxim Integrated Products, Inc.

Low-Voltage, Internal Switch, Step-Down Regulator

ELECTRICAL CHARACTERISTICS

(Circuit of Figure 1, $V_{IN} = V_{FREQ} = V_{CC} = V_{EN} = 5V$, $I_{REF} = \text{no load}$, $T_A = -40^\circ\text{C to } +85^\circ\text{C}$, unless otherwise noted. Typical values are at $T_A = +25^\circ\text{C}$.)

PARAMETER	SYMBOL	CONDITIONS	MIN	MAX	UNITS
Shutdown Supply Current		EN = GND, measured at V_{CC} , $T_A = +25^\circ\text{C}$		10	μA
Supply Current Regulator Enabled		Does not include switching losses, measured from V_{CC}		120	μA
REFERENCE					
Reference Output Voltage	V_{REF}	No load	1.145	1.265	V
INTERNAL 5A STEP-DOWN CONVERTER					
LX Peak Current Limit			4.35	8	A

Note 3: Limits are 100% production tested at $T_A = +25^\circ\text{C}$. Maximum and minimum limits are guaranteed by design and characterization.

Typical Operating Characteristics

(Circuit of Figure 1, $V_{IN} = 5V$, $V_{OUT} = 1.1V$, FREQ = open. $T_A = +25^\circ\text{C}$, unless otherwise noted.)

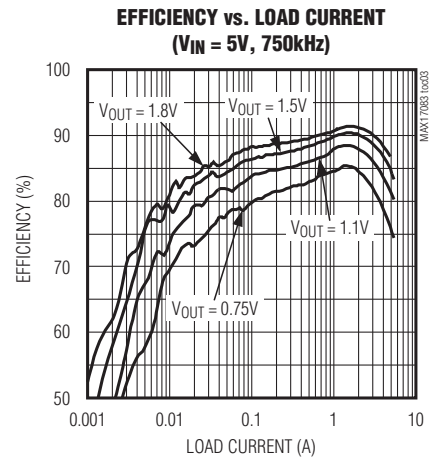
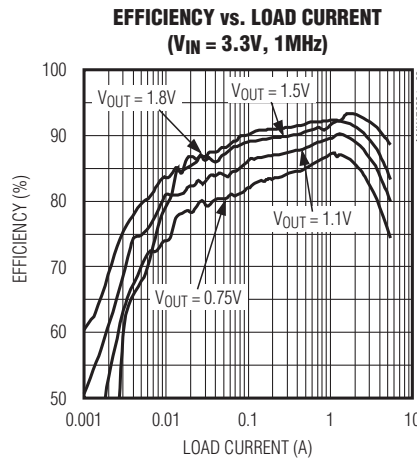
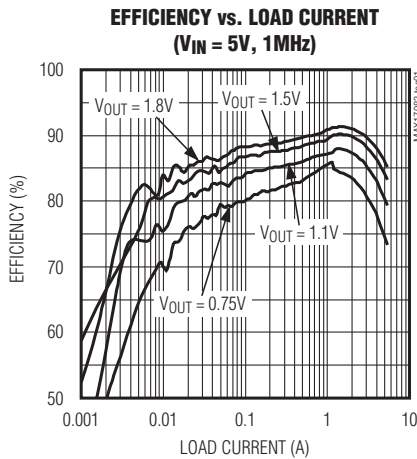

Low-Voltage, Internal Switch, Step-Down Regulator

MAX17083

Typical Operating Characteristics (continued)

(Circuit of Figure 1, $V_{IN} = 5V$, $V_{OUT} = 1.1V$, FREQ = open. $T_A = +25^\circ C$, unless otherwise noted.)

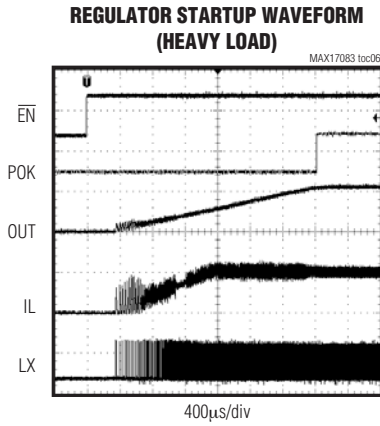
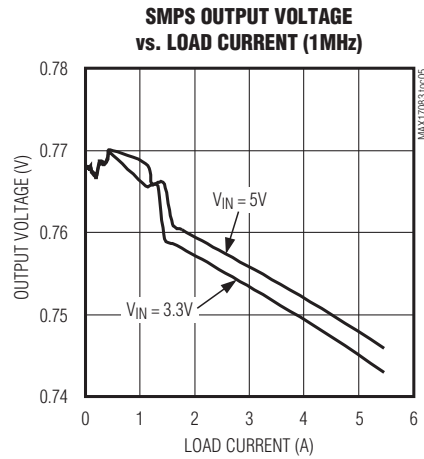
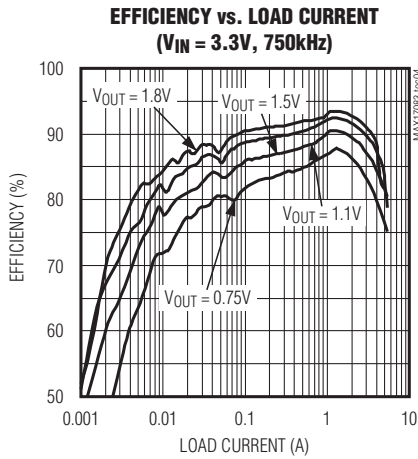

$f_{SW} = 750kHz$, $V_{IN} = 5V$, $R_{LOAD} = 0.22\Omega$
 $V_{OUT} = 1.1V$, POK: 2V/div
 EN: 5V/div, I_L : 5A/div
 OUT: 1V/div, LX: 5V/div

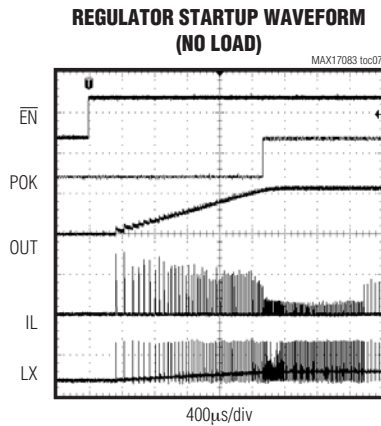

$f_{SW} = 1MHz$, $V_{IN} = 5V$, POK: 2V/div
 $V_{OUT} = 1.1V$, I_L : 5A/div
 EN: 5V/div, LX: 5V/div
 OUT: 1V/div

Low-Voltage, Internal Switch, Step-Down Regulator

Typical Operating Characteristics (continued)

(Circuit of Figure 1, $V_{IN} = 5V$, $V_{OUT} = 1.1V$, FREQ = open. $T_A = +25^\circ C$, unless otherwise noted.)

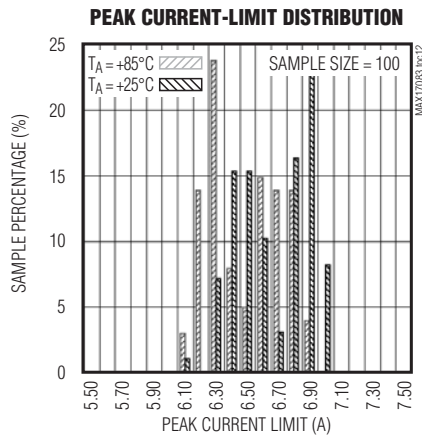
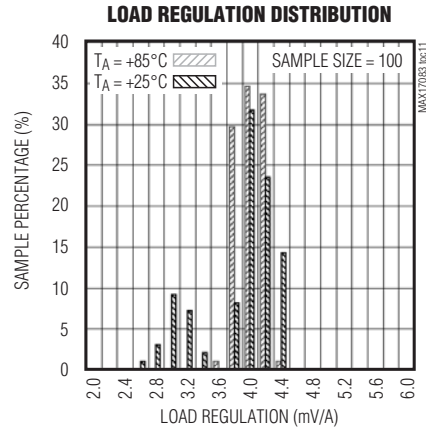
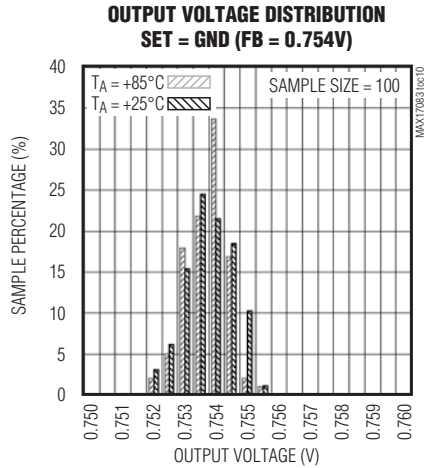
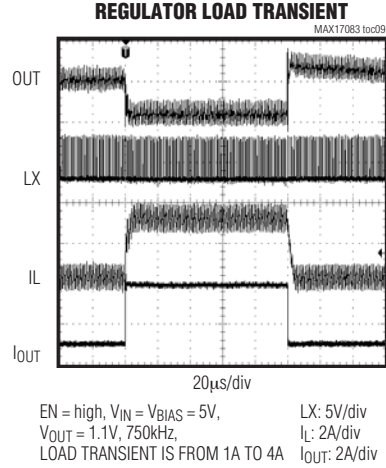
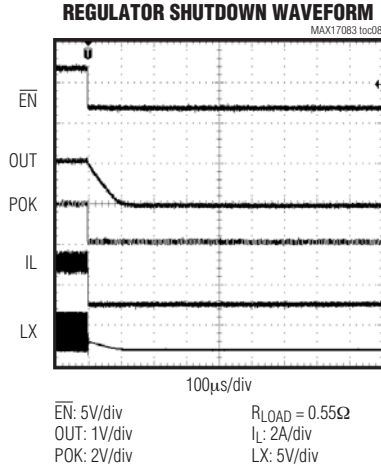

Low-Voltage, Internal Switch, Step-Down Regulator

Pin Description

MAX17083

PIN	NAME	FUNCTION										
1, 2, 17, 18	LX	Inductor Connection for the Internal 5A Step-Down Converter. Connect LX to the switched side of the inductor.										
3, 4	IN	Power Input Connection to the Drain of the Internal HS MOSFET. Bypass to PGND with a 10 μ F or greater ceramic capacitor close to the IC to minimize parasitic inductance.										
5	FREQ	Four-Level Switching Frequency (f_{sw}) Selection Pin										
		<table border="1"> <thead> <tr> <th>FREQUENCY PIN</th> <th>SWITCHING FREQUENCY (MHz)</th> </tr> </thead> <tbody> <tr> <td>V_{CC}</td> <td>1.5</td> </tr> <tr> <td>OPEN</td> <td>1.0</td> </tr> <tr> <td>REF</td> <td>0.75</td> </tr> <tr> <td>GND</td> <td>0.5</td> </tr> </tbody> </table>	FREQUENCY PIN	SWITCHING FREQUENCY (MHz)	V _{CC}	1.5	OPEN	1.0	REF	0.75	GND	0.5
		FREQUENCY PIN	SWITCHING FREQUENCY (MHz)									
		V _{CC}	1.5									
		OPEN	1.0									
REF	0.75											
GND	0.5											
6	POK	Open-Drain Power-Good Output. POK is pulled low if FB is more than 12% (typ) above or below the nominal regulation threshold. POK is held low during soft-start and in shutdown. POK becomes high impedance when FB is in regulation.										
7	REF	1.25V Reference Voltage Output. Bypass REF to analog ground with a 0.1 μ F ceramic capacitor. The reference sources up to 50 μ A for external loads. Loading REF degrades output voltage accuracy according to the REF load regulation error.										
8, 9, 10	GND	Analog Ground										
11, 19, 24	N.C.	No Connection										
12	FB	Feedback Input for the Internal 5A Step-Down Converter. FB regulation level can be preset by the SET pin.										
13	SET	Four-Level FB Threshold Selection Pin										
		<table border="1"> <thead> <tr> <th>FB THRESHOLD SELECTION PIN</th> <th>FB REGULATION VOLTAGE (V)</th> </tr> </thead> <tbody> <tr> <td>V_{CC}</td> <td>1.8</td> </tr> <tr> <td>OPEN</td> <td>1.5</td> </tr> <tr> <td>REF</td> <td>1.1</td> </tr> <tr> <td>GND</td> <td>0.75</td> </tr> </tbody> </table>	FB THRESHOLD SELECTION PIN	FB REGULATION VOLTAGE (V)	V _{CC}	1.8	OPEN	1.5	REF	1.1	GND	0.75
		FB THRESHOLD SELECTION PIN	FB REGULATION VOLTAGE (V)									
		V _{CC}	1.8									
		OPEN	1.5									
REF	1.1											
GND	0.75											
14	V _{CC}	5V Bias Supply Input for the Internal Switching Regulator Drivers. Bypass with a 1 μ F or greater ceramic capacitor. Provides power for the BST driver supplies.										
15	EN	Switching Regulator Enable Input. When EN is pulled low, LX is high impedance. When EN is driven high, the controller enables the 5A internal switching regulator.										
16	BST	Boost Flying Capacitor Connection for the Internal 5A Step-Down Converter. The MAX17083 includes an internal boost switch/diode connected between V _{CC} and BST. Connect to an external 0.1 μ F ceramic capacitor as shown in Figure 1.										
20–23	PGND	Power Ground										
EP	GND	Ground. Connect the exposed backside pad to analog ground.										

Low-Voltage, Internal Switch, Step-Down Regulator

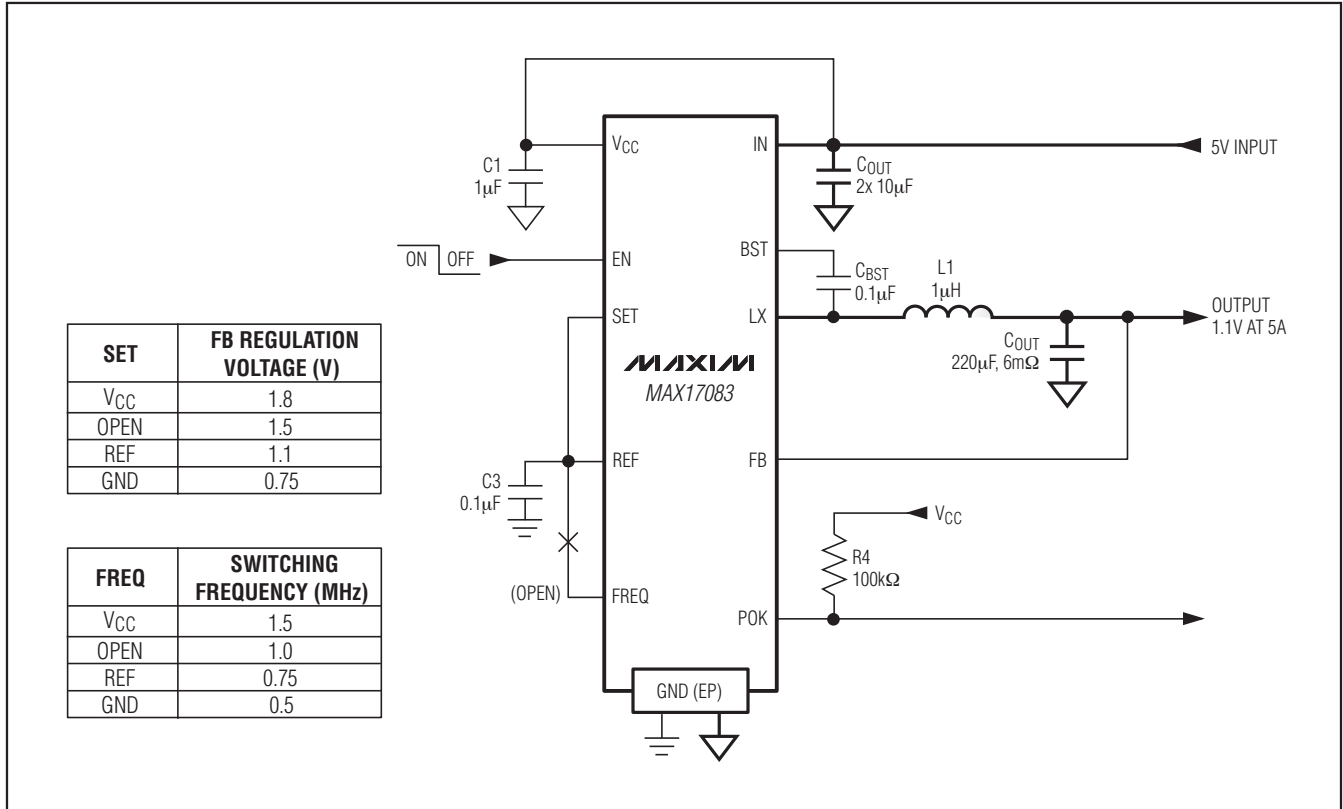

Figure 1. Standard Application Circuit

Detailed Description

The MAX17083 standard application circuit (Figure 1) provides a single 1.1V/5A chipset supply. The MAX17083 features a step-down switching regulator with dual internal n-channel MOSFET power switches.

These step-down regulators use a fixed-frequency, current-mode control scheme compensated by the output capacitor, providing an easy-to-implement architecture without sacrificing fast transient response. These regulators also provide peak current-limit protection, and operate pulse-skipping mode at light loads to maintain high efficiency.

Independent enable input and open-drain power-good output allow flexible system power sequencing. The voltage soft-start gradually ramps up the output voltage within a predictable time period and reduces inrush current. The MAX17083 features outputs undervoltage, output overvoltage, and thermal-fault protection.

Reference (REF)

The 1.25V reference is accurate to $\pm 1\%$ over temperature and load, making REF useful as a precision system reference. Bypass REF to GND with a 0.1µF or greater ceramic capacitor. The reference sources up to 50µA and sinks 5µA to support external loads. If highly accurate specifications are required for the main SMPS output voltages, the reference should not be loaded. Loading the reference slightly reduces the output voltage accuracy because of the reference load-regulation error as defined in the *Electrical Characteristics* table.

Low-Voltage, Internal Switch, Step-Down Regulator

MAX17083

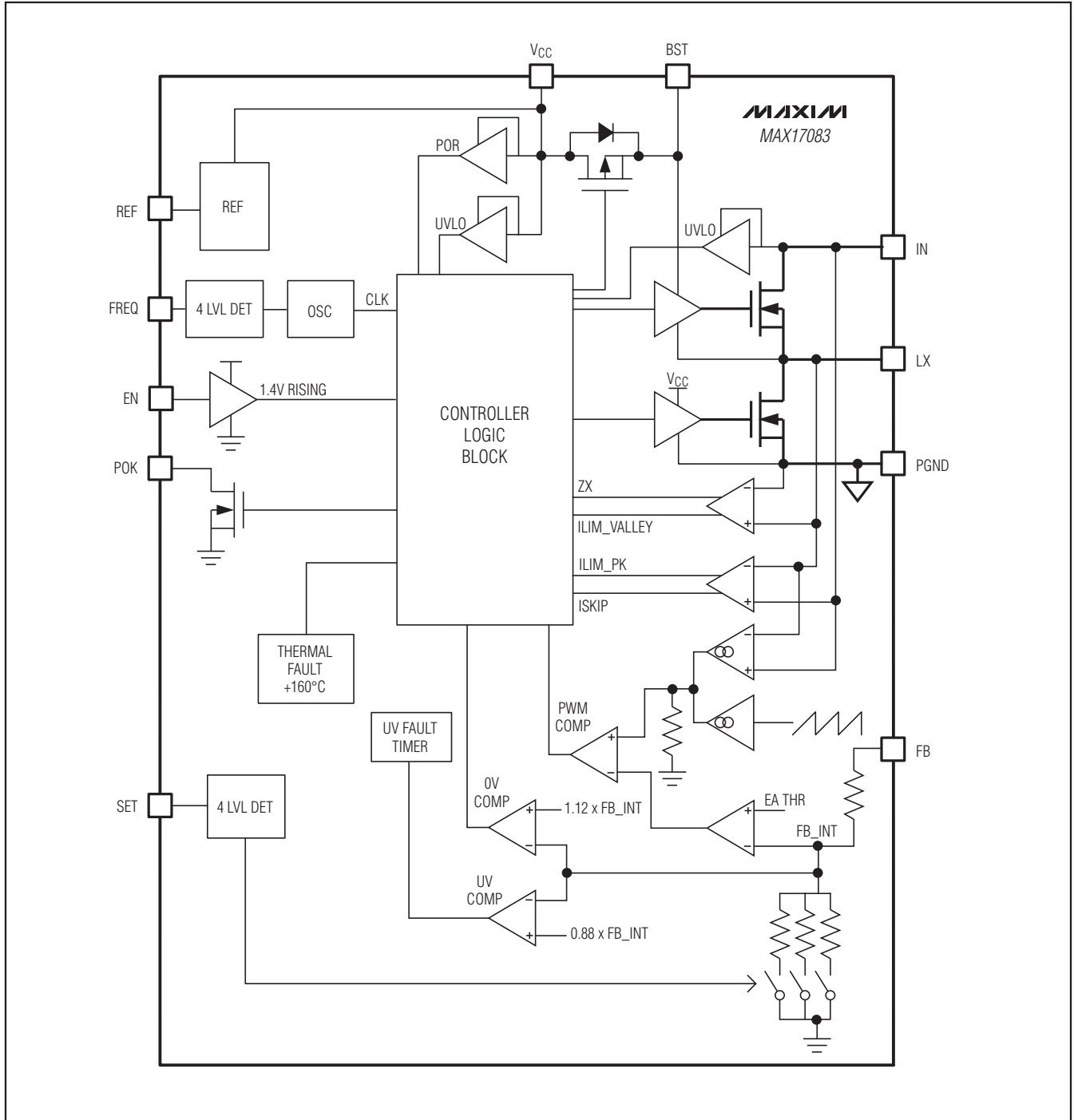

Figure 2. MAX17083 Block Diagram

Low-Voltage, Internal Switch, Step-Down Regulator

SMPS Detailed Description

Fixed-Frequency, Current-Mode PWM Controller

The heart of the current-mode PWM controller is a multi-stage, open-loop comparator that compares the output voltage-error signal with respect to the reference voltage, the current-sense signal, and the slope compensation ramp (Figure 2). The MAX17083 uses a direct-summing configuration, approaching ideal cycle-to-cycle control over the output voltage without a traditional error amplifier and the phase shift associated with it.

Frequency Selection (FREQ)

The FREQ input selects the PWM mode switching frequency. FREQ is a four-level input to set the regulator switching frequency. The regulator's switching frequency is set according to Table 1, and latched at the beginning of soft-start. High-frequency (FREQ = V_{CC}) operation optimizes the application for the smallest component size, trading off efficiency due to higher switching losses. This might be acceptable in ultra-portable devices where the load currents are lower. Low-frequency (FREQ = GND) operation offers the best overall efficiency at the expense of component size and board space.

Table 1. MAX17083 FREQ Table

FREQ PIN SELECT	SWITCHING FREQ, f _{sw}	SOFT-START TIME (ms) 1833/f _{sw}	STARTUP BLANKING TIME (ms) 3055/f _{sw}
V _{CC}	1.5MHz	1.22	2.0
Open	1MHz	1.83	3.1
REF	750kHz	2.44	4.1
GND	500kHz	3.67	6.1

FB Regulation Selection (SET)

The SET input selects one of the four preset feedback regulation voltage levels. The SET pin is a four-level input signal to set the FB regulation voltage. The regulator's feedback regulation voltage is set according to Table 2, and latched at the beginning of soft-start.

Table 2. MAX17083 SET Table

SET PIN SELECT	FB REGULATION VOLTAGE (V)
V _{CC}	1.8
Open	1.5
REF	1.1
GND	0.75

Adjustable Output-Voltage Operation Mode

The MAX17083 produces an adjustable 0.75V to 2.7V output voltage from the system's 3.3V or 5V input supply by using a resistive feedback divider. Set FB to 0.75V (SET = GND) in adjustable mode.

Light-Load Operation

An inherent automatic switchover to pulse-skipping (PFM operation) takes place at light loads. This switchover is affected by a comparator that truncates the low-side switch on-time at the inductor current's zero crossing. The zero-crossing comparator senses the inductor current during the off-time. Once the current through the low-side MOSFET drops below 100mA, the zero-crossing comparator, turns off the low-side MOSFET. This prevents the inductor from discharging the output capacitors and forces the switching regulator to skip pulses under light-load conditions to avoid overcharging the output.

Idle-Mode Current-Sense Threshold

When MAX17083 operates in pulse-skipping mode, the on-time of the step-down controller terminates when both the output voltage exceeds the feedback threshold, and the current-sense voltage exceeds the idle-mode current-sense threshold. Under light-load conditions, the on-time duration depends solely on the idle-mode current-sense threshold. This forces the controller to source a minimum amount of power with each cycle. To avoid overcharging the output, another on-time cannot be initiated until the output voltage drops below the feedback threshold. Since the zero-crossing comparator prevents the switching regulator from sinking current, the MAX17083 switching regulator must skip pulses. Therefore, the controller regulates the valley of the output ripple under light-load conditions.

The minimum idle-mode current requirement causes the threshold between pulse-skipping PFM operation and constant PWM operation to coincide with the boundary between continuous and discontinuous inductor-current operation (also known as the critical conduction point). The load-current level at which PFM/PWM crossover occurs (I_{LOAD(SKIP)}) is equivalent to half the idle-mode current threshold (see the *Electrical Characteristics* table for the idle-mode threshold of the regulator). The switching waveforms can appear noisy and asynchronous at light-load pulse-skipping operation, but this is a normal operating condition that results in high light-load efficiency. Trade-offs in PFM noise and light-load efficiency are made by varying the inductor value. Generally, low inductor values produce a broader efficiency vs. load

Low-Voltage, Internal Switch, Step-Down Regulator

curve, while higher values result in higher full-load efficiency (assuming that the coil resistance remains fixed) and less output voltage ripple. Penalties for using higher inductor values include larger physical size and degraded load-transient response (especially at low input-voltage levels).

SMPS POR, UVLO, and Soft-Start

Power-on reset (POR) occurs when V_{CC} rises above approximately 2.1V, resetting the undervoltage, overvoltage, and thermal-shutdown fault latches. The V_{CC} input undervoltage lockout (UVLO) circuitry prevents the switching regulators from operating if the 5V bias supply (V_{CC}) is below its 4V UVLO threshold.

Soft-Startup

The internal step-down controller starts switching and the output voltages ramp up using soft-start. If the bias supply voltage drops below the UVLO threshold, the controller stops switching and disables the drivers (LX becomes high impedance) until the bias supply voltage recovers.

Once the 5V bias supply and IN rise above their respective input UVLO thresholds, and EN is pulled high, the internal step-down controller becomes enabled and begins switching. The internal voltage soft-starts gradually increment the feedback voltage by approximately 25mV every 61 switching cycles. Therefore, OUT reaches its nominal regulation voltage 1833/f_{sw} after the regulator is enabled (see the Soft-Start Waveforms in the *Typical Operating Characteristics* section).

SMPS Power-Good Output (POK)

POK is the open-drain output of the window comparator that continuously monitors the output for undervoltage and overvoltage conditions. POK is actively held low in shutdown (EN = GND) and during soft-start. Once the soft-start sequence terminates, POK becomes high impedance as long as the output remains within $\pm 10\%$ of the nominal regulation voltage set by FB. POK goes low once the output drops 12% (typ) below or rises 12% (typ) above its nominal regulation point, or the output is shut down. For a logic-level POK output voltage, connect an external pullup resistor between POK and V_{CC} . A 100k Ω pullup resistor works well in most applications.

SMPS Fault Protection

Output Overvoltage Protection (OVP)

If the output voltage rises above 112% (typ) of its nominal regulation voltage, the controller sets the fault latch, pulls POK low, shuts down the regulator, and immediately pulls the output to ground through its low-side MOSFET. Turning on the low-side MOSFET with 100% duty cycle rapidly discharges the output capacitors and

clamps the output to ground. However, this commonly undamped response causes negative output voltages due to the energy stored in the output LC at the instant of 0V fault. If the load cannot tolerate a negative voltage, place a power Schottky diode across the output to act as a reverse-polarity clamp. If the condition that caused the overvoltage persists (such as a shorted high-side MOSFET), the input source also fails (short-circuit fault). Cycle V_{CC} below 1V or toggle the enable input to clear the fault latch and restart the regulator.

Output Undervoltage Protection (UVP)

Each MAX17083 includes an output undervoltage (UVP) protection circuit that begins to monitor the output once the startup blanking period has ended. If the output voltage drops below 88% (typ) of its nominal regulation voltage, the regulator pulls the POK output low and begins the UVP fault timer. Once the timer expires after 1600/f_{sw}, the regulator shuts down, forcing the high-side off and disabling the low-side MOSFET once the zero-crossing threshold has been reached. Cycle V_{CC} below 1V, or toggle the enable input to clear the fault latch and restart the regulator.

Thermal-Fault Protection

The MAX17083 features a thermal-fault protection circuit. When the junction temperature rises above +160°C (typ), a thermal sensor activates the fault latch, pulls down the POK output, and shuts down the regulator. Toggle EN to clear the fault latch, and restart the controllers after the junction temperature cools by 15°C (typ).

SMPS Design Procedure (Step-Down Regulator)

Firmly establish the input voltage range and maximum load current before choosing a switching frequency and inductor operating point (ripple-current ratio). The primary design trade-off lies in choosing a good switching frequency and inductor operating point, and the following four factors dictate the rest of the design:

- **Input Voltage Range.** The maximum value ($V_{IN(MAX)}$), and minimum value ($V_{IN(MIN)}$) must accommodate the worst-case conditions accounting for the input voltage soars and drops. If there is a choice at all, lower input voltages result in better efficiency.
- **Maximum Load Current.** There are two values to consider. The peak load current ($I_{LOAD(MAX)}$) determines the instantaneous component stresses and filtering requirements and thus drives output-capacitor selection, inductor-saturation rating, and the design of the current-limit circuit. The continuous load current

Low-Voltage, Internal Switch, Step-Down Regulator

(I_{LOAD}) determines the thermal stresses and thus drives the selection of input capacitors, MOSFETs, and other critical heat-contributing components.

- **Switching Frequency.** This choice determines the basic trade-off between size and efficiency. The optimal frequency is largely a function of maximum input voltage due to MOSFET switching losses that are proportional to frequency and the square of V_{IN} . The optimum frequency is also a moving target, due to rapid improvements in MOSFET technology that are making higher frequencies more practical.
- **Inductor Operating Point.** This choice provides trade-offs between size and efficiency, and between transient response and output ripple. Low inductor values provide better transient response and smaller physical size, but also result in lower efficiency and higher output ripple due to increased ripple currents. The minimum practical inductor value is one that causes the circuit to operate at the edge of critical conduction (where the inductor current just touches zero with every cycle at maximum load). Inductor values lower than this grant no further size-reduction benefit. The optimum operating point is usually found between 20% and 50% of ripple current. When pulse skipping (at light loads), the inductor value also determines the load-current value at which PFM/PWM switchover occurs.

Step-Down Inductor Selection

The switching frequency and inductor operating point determine the inductor value as follows:

$$L = \frac{V_{OUT} \times (V_{IN} - V_{OUT})}{V_{IN} \times f_{OSC} \times I_{LOAD(MAX)} \times LIR}$$

Assuming 5A maximum load current, and an LIR of 0.3 yields:

$$L = \frac{V_{OUT} \times (V_{IN} - V_{OUT})}{V_{IN} \times f_{OSC} \times 1.5}$$

Find a low-loss inductor having the lowest possible DC resistance that fits in the allotted dimensions. Most inductor manufacturers provide inductors in standard values, such as 1.0 μ H, 1.5 μ H, 2.2 μ H, 3.3 μ H, etc. Also look for nonstandard values, which can provide a better compromise in LIR across the input voltage range. If using a swinging inductor (where the no-load inductance decreases linearly with increasing current), evaluate the LIR with properly scaled inductance values. For

the selected inductance value, the actual peak-to-peak inductor ripple current ($\Delta I_{INDUCTOR}$) is defined by:

$$\Delta I_{INDUCTOR} = \frac{V_{OUT} (V_{IN} - V_{OUT})}{V_{IN} f_{OSC} L}$$

Ferrite cores are often the best choice, although soft saturating molded core inductors are inexpensive and can work well at 500kHz. The core must be large enough not to saturate at the peak inductor current (I_{PEAK}):

$$I_{PEAK} = I_{LOAD(MAX)} + \left(\frac{\Delta I_{INDUCTOR}}{2} \right)$$

SMPS Output-Capacitor Selection

The output filter capacitor selection requires careful evaluation of several different design requirements—stability, transient response, and output ripple voltage—that place limits on the output capacitance and ESR. Based on these requirements, the typical application requires a low-ESR polymer capacitor (lower cost but higher output-ripple voltage) or bulk ceramic capacitors (higher cost but low output-ripple voltage).

SMPS Loop Compensation

Voltage positioning dynamically lowers the output voltage in response to the load current, reducing the loop gain. This reduces the output capacitance requirement (stability and transient) and output power dissipation requirements as well. The load-line is generated by sensing the inductor current through the high-side MOSFET on-resistance, and is internally preset to -5mV/A (typ). The load-line ensures that the output voltage remains within the regulation window over the full-load conditions.

The load line of the internal SMPS regulators also provides the AC ripple voltage required for stability. To maintain stability, the output capacitive ripple must be kept smaller than the internal AC ripple voltage, and crossover must occur before the Nyquist pole occurs $(1 + \text{duty}) / (2f_{SW})$. Based on these loop requirements, a minimum output capacitance can be determined from the following:

$$C_{OUT} > \left(\frac{1}{2f_{SW} R_{DROOP}} \right) \left(\frac{V_{REF}}{V_{OUT}} \right) \left(1 + \frac{V_{OUT}}{V_{IN}} \right)$$

where R_{DROOP} is 5mV/A as defined in the *Electrical Characteristics* table and f_{SW} is the switching frequency selected by the FREQ setting (see Table 1).

Low-Voltage, Internal Switch, Step-Down Regulator

Additionally, an additional feedback pole—capacitor from FB to analog ground (C_{FB})—might be necessary to cancel the unwanted ESR zero of the output capacitor. In general, if the ESR zero occurs before the Nyquist pole, then canceling the ESR zero is recommended.

If:

$$ESR > \left(\frac{1+D}{4\pi f_{SW} C_{OUT}} \right)$$

Then:

$$C_{FB} > \left(\frac{C_{OUT} ESR}{R_{FB}} \right)$$

where R_{FB} is the parallel impedance of the FB resistive divider.

SMPS Output Ripple Voltage

With polymer capacitors, the effective series resistance (ESR) dominates and determines the output ripple voltage. The step-down regulator's output ripple voltage (V_{RIPPLE}) equals the total inductor ripple current ($\Delta I_{INDUCTOR}$) multiplied by the output capacitor's ESR. Therefore, the maximum ESR to meet the output ripple voltage requirement is:

$$R_{ESR} \leq \left[\frac{V_{IN} f_{SW} L}{(V_{IN} - V_{OUT}) V_{OUT}} \right] V_{RIPPLE}$$

where f_{SW} is the switching frequency. The actual capacitance value required relates to the physical case size needed to achieve the ESR requirement, as well as to the capacitor chemistry. Thus, polymer capacitor selection is usually limited by ESR and voltage rating rather than by capacitance value. Alternatively, combining ceramics (for the low ESR) and polymers (for the bulk capacitance) helps balance the output capacitance vs. output ripple voltage requirements.

Internal SMPS Transient Response

The load-transient response depends on the overall output impedance over frequency, and the overall amplitude and slew rate of the load step. In applications with large, fast load transients (load step > 80% of full load and slew rate > 10A/ μ s), the output capacitor's high-frequency response—ESL and ESR—needs to be considered. To prevent the output voltage from spiking too low under a load-transient event, the ESR is limited by the following equation (ignoring the sag due to finite capacitance):

$$R_{ESR} \leq \left(\frac{V_{STEP}}{\Delta I_{LOAD(MAX)}} - R_{PCB} \right)$$

where V_{STEP} is the allowed voltage drop, $\Delta I_{LOAD(MAX)}$ is the maximum load step, and R_{PCB} is the parasitic board resistance between the load and output capacitor.

The capacitance value dominates the midfrequency output impedance and continues to dominate the load-transient response as long as the load transient's slew rate is fewer than two switching cycles. Under these conditions, the sag and soar voltages depend on the output capacitance, inductance value, and delays in the transient response. Low inductor values allow the inductor current to slew faster, replenishing charge removed from or added to the output filter capacitors by a sudden load step, especially with low differential voltages across the inductor. The sag voltage (V_{SAG}) that occurs after applying the load current can be estimated by the following:

$$V_{SAG} = \frac{L (\Delta I_{LOAD(MAX)})^2}{2C_{OUT} (V_{IN} \times D_{MAX} - V_{OUT})} + \frac{\Delta I_{LOAD(MAX)} (T - \Delta T)}{C_{OUT}}$$

where D_{MAX} is the maximum duty factor (see the *Electrical Characteristics* table), T is the switching period ($1/f_{OSC}$), and ΔT equals $V_{OUT}/V_{IN} \times T$ when in PWM mode, or $L \times I_{IDLE}/(V_{IN} - V_{OUT})$ when in pulse-skipping mode. The amount of overshoot voltage (V_{SOAR}) that occurs after load removal (due to stored inductor energy) can be calculated as:

$$V_{SOAR} \approx \frac{(\Delta I_{LOAD(MAX)})^2 L}{2C_{OUT} V_{OUT}}$$

When using low-capacity ceramic filter capacitors, capacitor size is usually determined by the capacity needed to prevent V_{SOAR} from causing problems during load transients. Generally, once enough capacitance is added to meet the overshoot requirement, undershoot at the rising load edge is no longer a problem.

Input-Capacitor Selection

The input capacitor must meet the ripple current requirement (I_{RMS}) imposed by the switching currents. The I_{RMS} requirements of the regulator can be determined by the following equation:

$$I_{RMS} = \left(\frac{I_{LOAD}}{V_{IN}} \right) \sqrt{V_{OUT} (V_{IN} - V_{OUT})}$$

The worst-case RMS current requirement occurs when operating with $V_{IN} = 2V_{OUT}$. At this point, the above equation simplifies to $I_{RMS} = 0.5 \times I_{LOAD}$.

Low-Voltage, Internal Switch, Step-Down Regulator

For the MAX17083 system (IN) supply, ceramic capacitors are preferred due to their resilience to inrush surge currents typical of systems, and due to their low parasitic inductance, which helps reduce the high-frequency ringing on the IN supply when the internal MOSFETs are turned off. Choose an input capacitor that exhibits less than +10°C temperature rise at the RMS input current for optimal circuit longevity.

BST Capacitors

The boost capacitor (C_{BST}) must be selected large enough to handle the gate charging requirements of the high-side MOSFETs. For these low-power applications, 0.1µF ceramic capacitors work well.

Applications Information

Duty-Cycle Limits

Minimum Input Voltage

The minimum input operating voltage (dropout voltage) is restricted by the maximum duty-cycle specification (see the *Electrical Characteristics* table). For the best dropout performance, use the slowest switching frequency setting (FREQ = GND). However, keep in mind that the transient performance gets worse as the step-down regulators approach the dropout voltage, so bulk output capacitance must be added (see the voltage sag and soar equations in the *SMPS Design Procedure* section). The absolute point of dropout occurs when the inductor current ramps down during the off-time (ΔI_{DOWN}) as much as it ramps up during the on-time (ΔI_{UP}). This results in a minimum operating voltage defined by the following equation:

$$V_{IN(MIN)} = V_{OUT} + V_{CHG} + h \left(\frac{1}{D_{MAX}} - 1 \right) (V_{OUT} + V_{DIS})$$

where V_{CHG} and V_{DIS} are the parasitic voltage drops in the charge and discharge paths, respectively. A reasonable minimum value for h is 1.5, while the absolute minimum input voltage is calculated with $h = 1$.

Maximum Input Voltage

The MAX17083 controller includes a minimum on-time specification, which determines the maximum input operating voltage that maintains the selected switching frequency (see the *Electrical Characteristics* table).

Operation above this maximum input voltage results in pulse skipping to avoid overcharging the output. At the beginning of each cycle, if the output voltage is still above the feedback threshold voltage, the controller does not trigger an on-time pulse, effectively skipping a cycle. This allows the controller to maintain regulation above the maximum input voltage, but forces the controller to effectively operate with a lower switching frequency. This results in an input threshold voltage at which the controller begins to skip pulses ($V_{IN(SKIP)}$):

$$V_{IN(SKIP)} = V_{OUT} \left(\frac{1}{f_{OSC} t_{ON(MIN)}} \right)$$

where f_{OSC} is the switching frequency selected by FREQ.

PCB Layout Guidelines

Careful PCB layout is critical to achieving low switching losses and clean, stable operation. The switching power stage requires particular attention. If possible, mount all the power components on the top side of the board, with their ground terminals flush against one another.

Follow the MAX17083 Evaluation Kit layout and use the following guidelines for good PCB layout:

- Keep the high-current paths short, especially at the ground terminals. This practice is essential for stable, jitter-free operation.
- Keep the power traces and load connections short. This practice is essential for high efficiency. Using thick copper PCBs (2oz vs. 1oz) can enhance full-load efficiency by 1% or more. Correctly routing PCB traces is a difficult task that must be approached in terms of fractions of centimeters, where a single milliohm of excess trace resistance causes a measurable efficiency penalty.
- When trade-offs in trace lengths must be made, it is preferable to allow the inductor charging path to be made longer than the discharge path. For example, it is better to allow some extra distance between the input capacitors and the high-side MOSFET than to allow distance between the inductor and the low-side MOSFET or between the inductor and the output filter capacitor.
- Route high-speed switching nodes (BST and LX) away from sensitive analog areas (REF and FB).

Low-Voltage, Internal Switch, Step-Down Regulator

Chip Information

PROCESS: BiCMOS

Package Information

For the latest package outline information and land patterns, go to www.maxim-ic.com/packages.

PACKAGE TYPE	PACKAGE CODE	DOCUMENT NO.
24 TQFN-EP	T2444-4	21-0139

MAX17083

Maxim cannot assume responsibility for use of any circuitry other than circuitry entirely embodied in a Maxim product. No circuit patent licenses are implied. Maxim reserves the right to change the circuitry and specifications without notice at any time.

Maxim Integrated Products, 120 San Gabriel Drive, Sunnyvale, CA 94086 408-737-7600 _____ 15