



# THDT6511D

## Application Specific Discretes TRANSIENT VOLTAGE SUPPRESSOR A.S.D.™ FOR SLIC PROTECTION

### FEATURES

- DUAL ASYMETRICAL TRANSIENT SUPPRESSOR
- PEAK PULSE CURRENT :  $I_{PP} = 40A$ , 10/100 $\mu s$
- HOLDING CURRENT : 150 mA min.
- BREAKDOWN VOLTAGE : 65 V min.
- LOW DYNAMIC CHARACTERISTICS
- STAND CCITT K20 AND LSSGR

### DESCRIPTION

This device has been especially designed to protect subscriber line cards against overvoltage.

Two diodes clamp positive overloads while negative surges are suppressed by two protection thyristors.

A particular attention has been given to the internal wire bonding. The "4-point" configuration ensures a reliable protection, eliminating overvoltages introduced by the parasitic inductances of the wiring ( $Ldi/dt$ ), especially for very fast transient overvoltages.

### COMPLIES WITH THE FOLLOWING STANDARDS :

<b>CCITT K20 :</b>	10/700 $\mu s$	1kV
	5/310 $\mu s$	38A
<b>VDE 0433 :</b>	10/700 $\mu s$	2kV
	5/310 $\mu s$	50A
<b>VDE 0878 :</b>	1.2/50 $\mu s$	1.5kV
	1/20 $\mu s$	40A
<b>I3124 :</b>	0.5/700 $\mu s$	1kV
	0.2/310 $\mu s$	38A
<b>FCC part 68 :</b>	2/10 $\mu s$	2.5kV
	2/10 $\mu s$	125A (*)
<b>BELLCORE TR-NWT-001089 :</b>	2/10 $\mu s$	2.5kV
	2/10 $\mu s$	125A (*)
	10/1000 $\mu s$	1kV
	10/1000 $\mu s$	40A (*)

(\*) with series resistors or PTC.

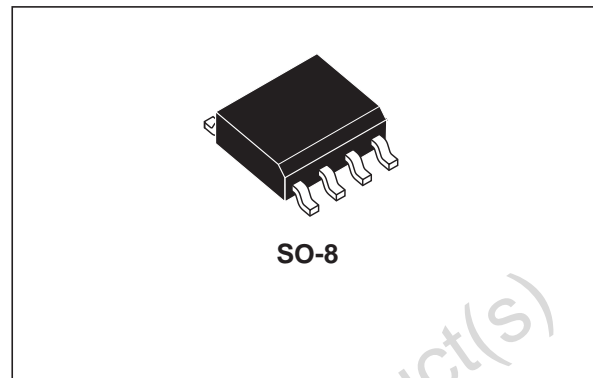

SO-8

### SCHEMATIC DIAGRAM

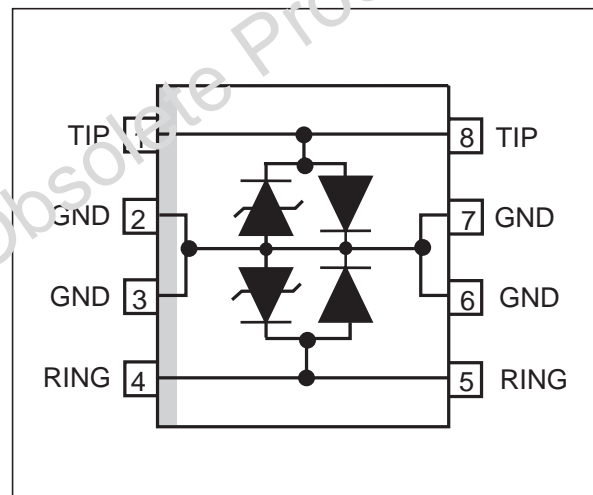

# THDT6511D

## ABSOLUTE MAXIMUM RATINGS (T<sub>amb</sub> = 25°C)

Symbol	Parameter	Value	Unit	
I <sub>PP</sub>	Peak pulse current (see note 1)	10/1000µs 5/310µs 2/10µs	40 50 125	A
I <sub>TSM</sub>	Non repetitive surge peak on-state current F = 50 Hz	t = 300 ms t = 1 s t = 5 s	10 3.5 1	A
I <sub>TSM</sub>	F = 50 Hz, 60 x 1 s, 2 mn between pulse		1	A
T <sub>stg</sub> T <sub>j</sub>	Storage temperature range Maximum junction temperature		- 55 to + 150 150	°C
T <sub>L</sub>	Maximum lead temperature for soldering during 10s		260	°C

Note 1 : Pulse waveform :

10/1000µs	t <sub>r</sub> =10µs	t <sub>p</sub> =1000µs
5/310µs	t <sub>r</sub> =5µs	t <sub>p</sub> =310µs
2/10µs	t <sub>r</sub> =2µs	t <sub>p</sub> =10µs

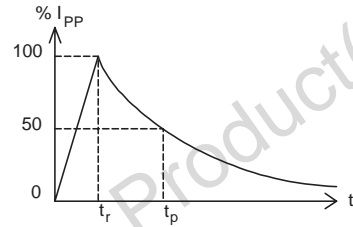

## THERMAL RESISTANCES

Symbol	Parameter	Value	Unit
R <sub>th(j-a)</sub>	Junction to ambient	170	°C/W

## ELECTRICAL CHARACTERISTICS

(T<sub>amb</sub> = 25°C)

Symbol	Parameter
V <sub>RM</sub>	Stand-off voltage
I <sub>RM</sub>	Leakage current at stand-off voltage
V <sub>BR</sub>	Breakdown voltage
V <sub>BO</sub>	Breakover voltage
I <sub>H</sub>	Holding current
V <sub>F</sub>	Forward voltage drop
V <sub>FP</sub>	Peak forward voltage
I <sub>BO</sub>	Breakover current
I <sub>PP</sub>	Peak pulse current
C	Capacitance
αT	Temperature coefficient

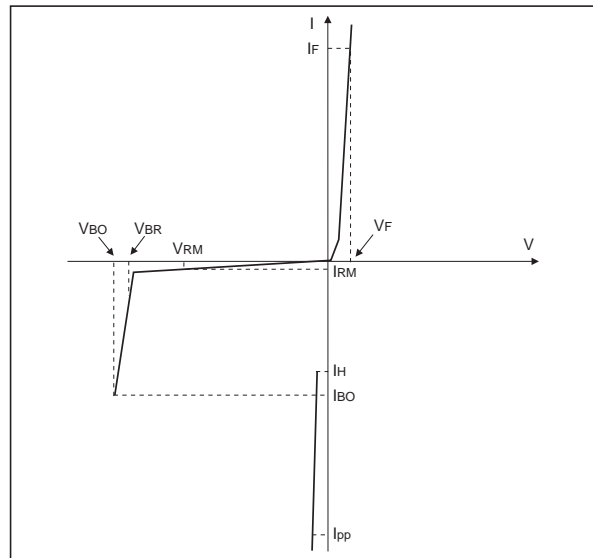

## 1 - PARAMETERS RELATED TO DIODE LINE / GND

Symbol	Test conditions	Min.	Typ.	Max.	Unit
$V_F$	$I_F = 1 \text{ A}$ $t_p = 100 \mu\text{s}$			2	V
$V_{FP}$	see curve fig. 1	NA	NA	NA	V

NA : Non Available

## 2 - PARAMETERS RELATED TO PROTECTION THYRISTOR

Symbol	Tests conditions	Min.	Typ.	Max.	Unit
$V_{BR}$	$I_R = 1 \text{ mA}$	65			V
$V_{BO}$		68		85	V
$I_{RM}$	$V_{RM} = 63 \text{ V}$			100	$\mu\text{A}$
$I_{BO}$	$t_p = 100 \mu\text{s}$	110		450	mA
$I_{BO}$	$F = 50 \text{ Hz}$ $RG = 600 \Omega$			500	mA
$I_H$		150			mA
$\alpha T$			15		$10^{-4}/^\circ\text{C}$
C	$V_D = 100 \text{ mV}_{RMS}$ $F = 1 \text{ KHz}$			500	pF
dV/dt	Linear ramp up to 67 % of $V_{BR}$	5			kV / $\mu\text{s}$

**THDT6511D**

**DYNAMIC CHARACTERISTICS :  $V_{FP}$  and  $V_{BO}$**

**Figure 1 :**

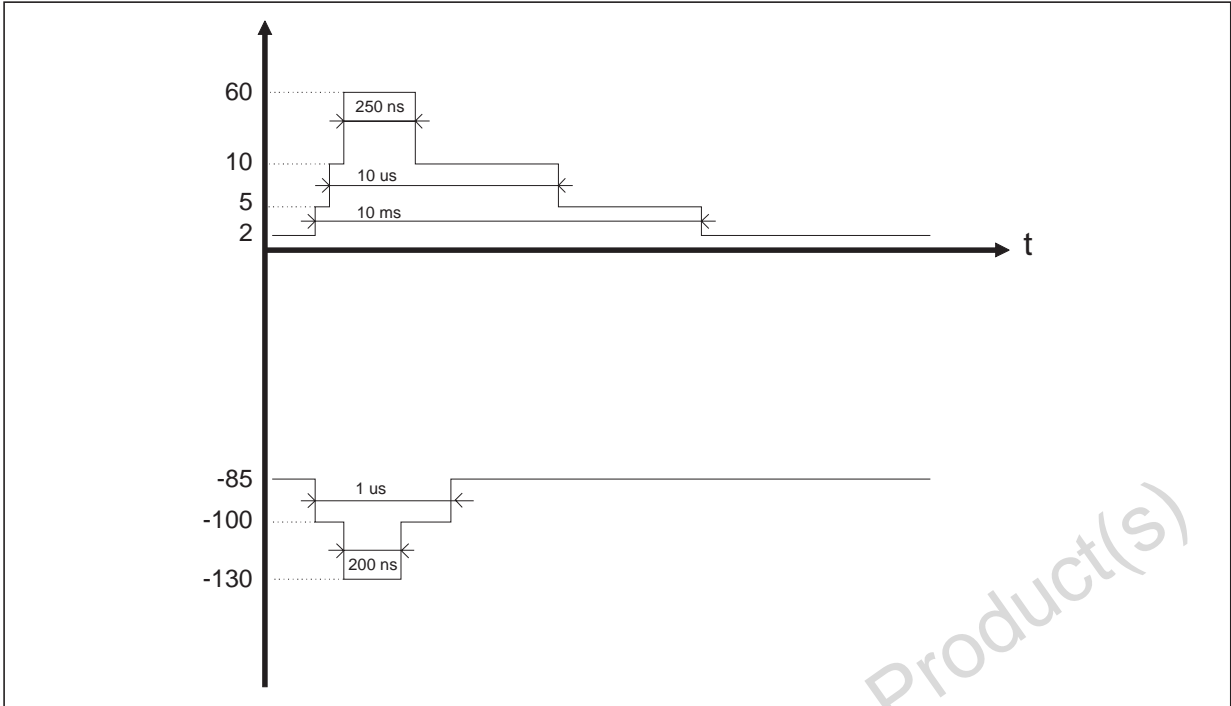

Under lightning and power crossing test, the device limits the transient voltage to the values indicated in the figure

**LSSGR TEST DIAGRAM**

**Figure 2 :**

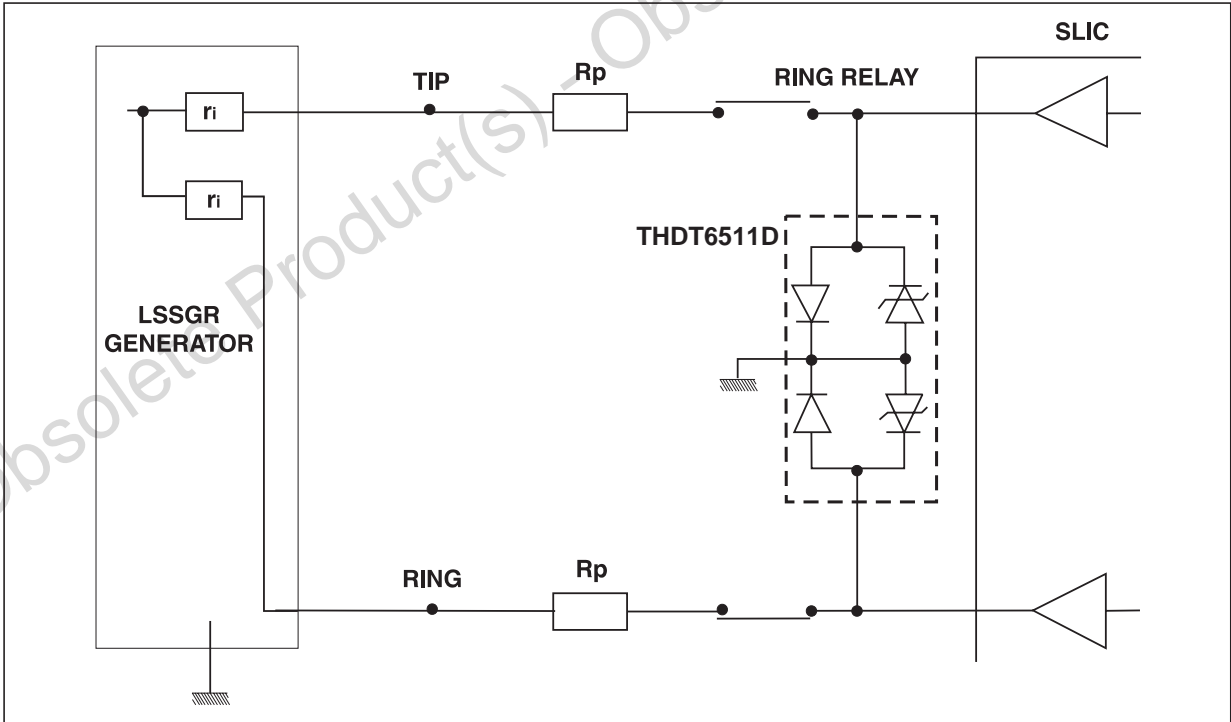

To stand the LSSGR test requirements,  $R_p$  must be | 15  $\Omega$

TYPICAL APPLICATION

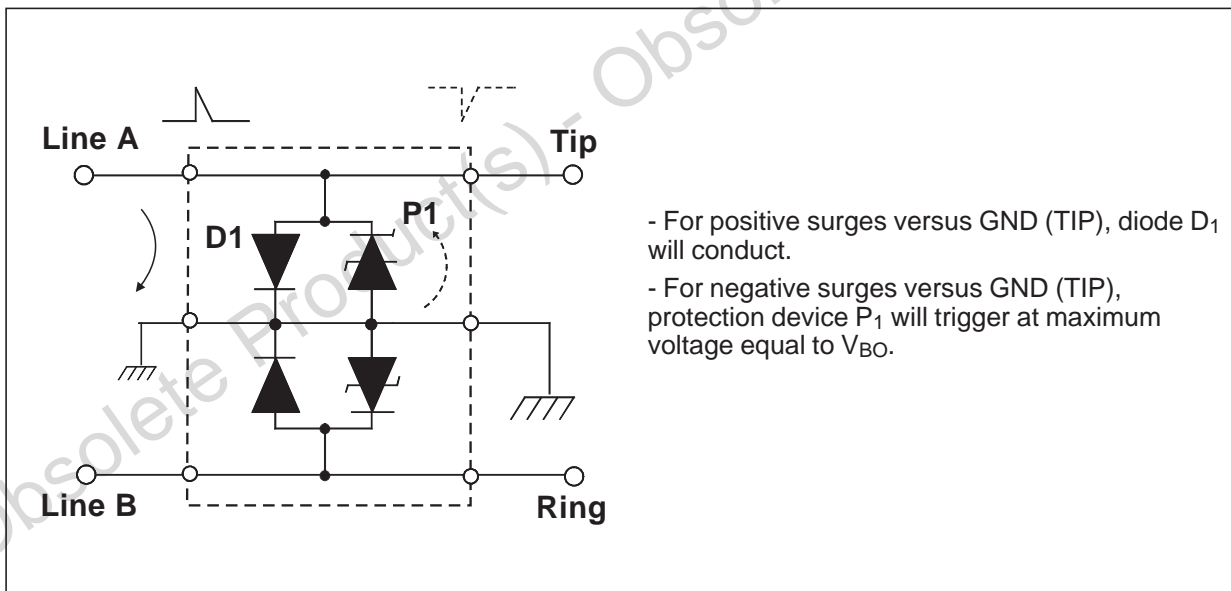
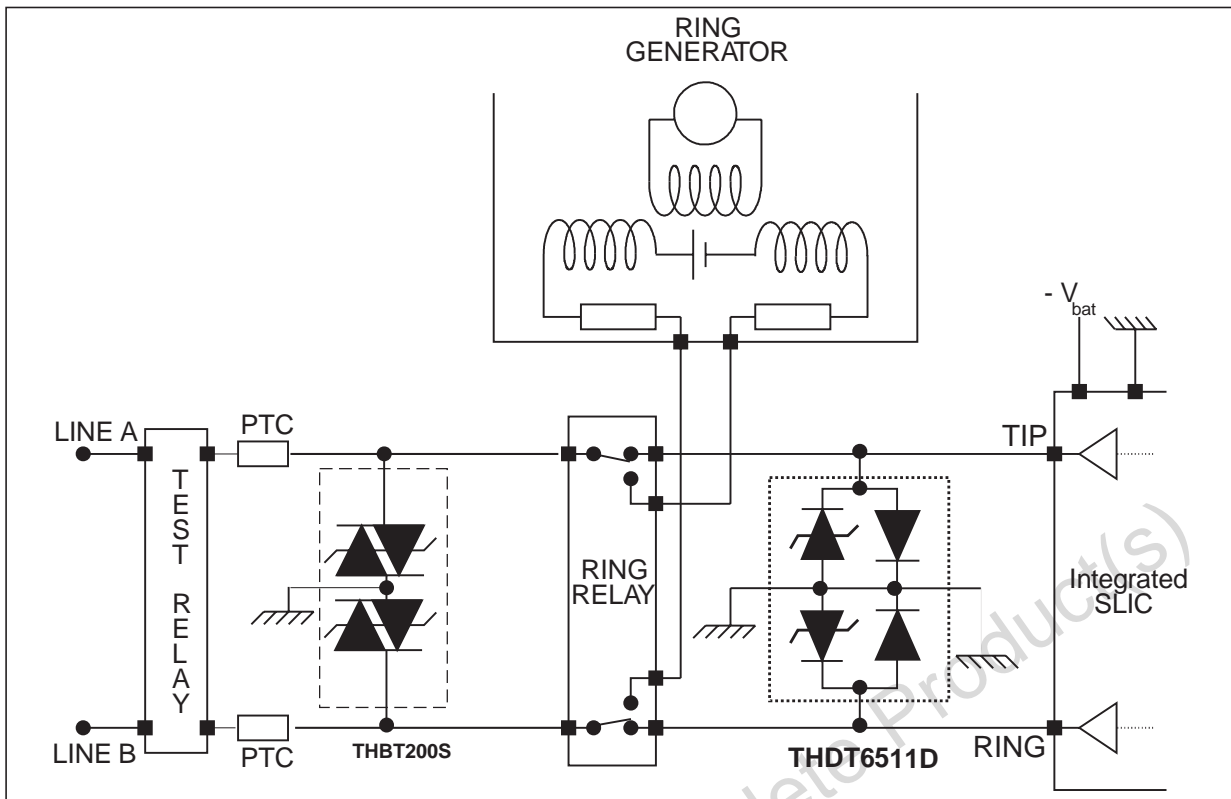

# THDT6511D

## ORDER CODE

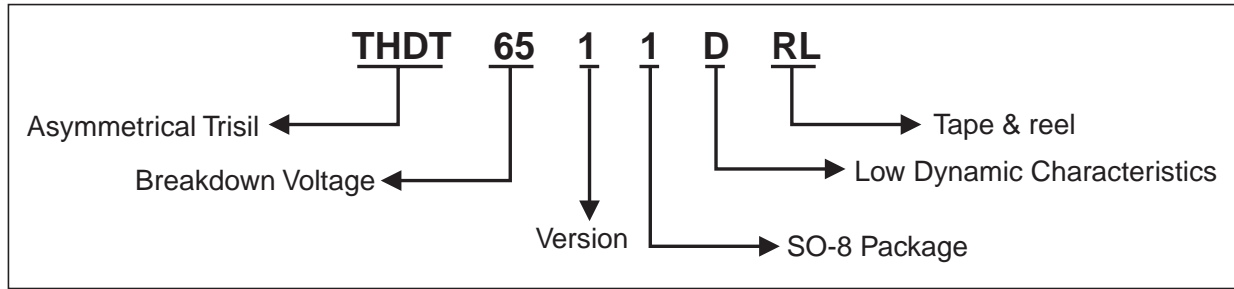

## PACKAGE MECHANICAL DATA. SO-8 Plastic

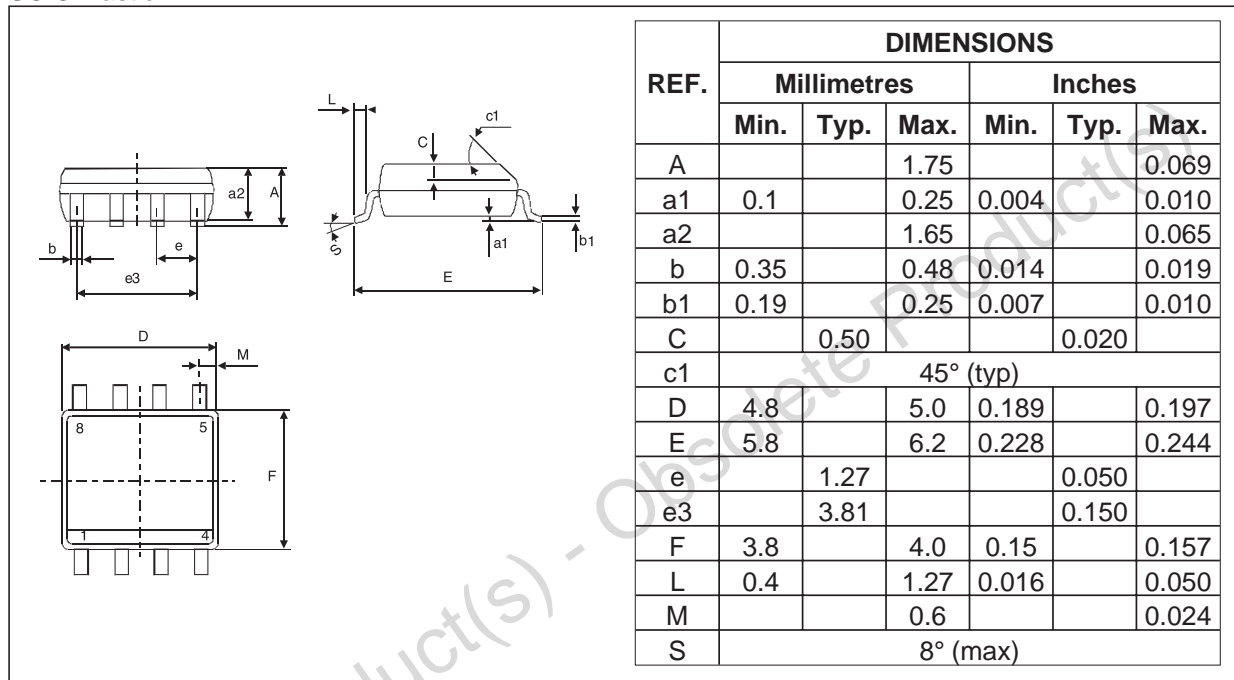

**MARKING : DT651D**

**PACKAGING :** Products supplied in antistatic tube or tape and reel.

**Weight :** 0.08g

Information furnished is believed to be accurate and reliable. However, STMicroelectronics assumes no responsibility for the consequences of use of such information nor for any infringement of patents or other rights of third parties which may result from its use. No license is granted by implication or otherwise under any patent or patent rights of STMicroelectronics. Specifications mentioned in this publication are subject to change without notice. This publication supersedes and replaces all information previously supplied. STMicroelectronics products are not authorized for use as critical components in life support devices or systems without express written approval of STMicroelectronics.

The ST logo is a registered trademark of STMicroelectronics

© 2001 STMicroelectronics - Printed in Italy - All rights reserved.

STMicroelectronics GROUP OF COMPANIES

Australia - Brazil - China - Finland - France - Germany - Hong Kong - India - Italy - Japan - Malaysia  
Malta - Morocco - Singapore - Spain - Sweden - Switzerland - United Kingdom - U.S.A.

<http://www.st.com>

