

**Features**

- Epitaxial Planar Die Construction
- Complementary PNP Type Available (DCP51)
- Ideally Suited for Automated Assembly Processes
- Ideal for Medium Power Switching or Amplification Applications
- **Lead Free By Design/RoHS Compliant (Note 1)**
- **"Green" Device (Note 2)**

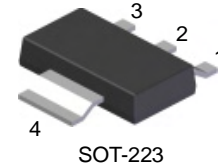

**Mechanical Data**

- Case: SOT-223
- Case Material: Molded Plastic, "Green" Molding Compound. UL Flammability Classification Rating 94V-0
- Moisture Sensitivity: Level 1 per J-STD-020C
- Terminals: Finish — Matte Tin annealed over Copper Leadframe (Lead Free Plating). Solderable per MIL-STD-202, Method 208
- Marking & Type Code Information: See Page 3
- Ordering Information: See Page 3
- Weight: 0.115 grams (approximate)

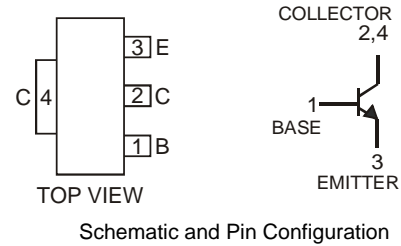

**Maximum Ratings** @T<sub>A</sub> = 25°C unless otherwise specified

Characteristic	Symbol	Value	Unit
Collector-Emitter Voltage	V <sub>CEO</sub>	45	V
Collector-Base Voltage	V <sub>CBO</sub>	45	V
Emitter-Base Voltage	V <sub>EBO</sub>	5	V
Continuous Collector Current	I <sub>C</sub>	1	A

**Thermal Characteristics**

Characteristic	Symbol	Value	Unit
Power Dissipation (Note 3) @T <sub>A</sub> = 25°C	P <sub>d</sub>	1	W
Operating and Storage Temperature Range	T <sub>j</sub> , T <sub>STG</sub>	-55 to +150	°C
Thermal Resistance Junction to Ambient Air @ T <sub>A</sub> = 25°C (Note 3)	R <sub>θJA</sub>	125	°C/W

**Electrical Characteristics** @T<sub>A</sub> = 25°C unless otherwise specified

Characteristic	Symbol	Min	Typ	Max	Unit	Test Condition
<b>Off Characteristics (Note 4)</b>						
Collector-Base Breakdown Voltage	V <sub>(BR)CBO</sub>	45	—	—	V	I <sub>C</sub> = 100μA
Collector-Emitter Breakdown Voltage	V <sub>(BR)CEO</sub>	45	—	—	V	I <sub>C</sub> = 10mA
Emitter-Base Breakdown Voltage	V <sub>(BR)EBO</sub>	5	—	—	V	I <sub>E</sub> = 10μA
Collector-Base Cutoff Current	I <sub>CBO</sub>	—	—	100 10	nA μA	V <sub>CB</sub> = 30V, I <sub>E</sub> = 0 V <sub>CB</sub> = 30V, I <sub>E</sub> = 0, T <sub>A</sub> = 150°C
Emitter-Base Cutoff Current	I <sub>EBO</sub>	—	—	10	μA	V <sub>EB</sub> = 5V, I <sub>C</sub> = 0A
<b>On Characteristics (Note 4)</b>						
DC Current Gain	h <sub>FE</sub>	63	—	—	—	I <sub>C</sub> = 5mA, V <sub>CE</sub> = 2V
		63	—	250		I <sub>C</sub> = 150mA, V <sub>CE</sub> = 2V
		40	—	—		I <sub>C</sub> = 500mA, V <sub>CE</sub> = 2V
DCP54-16		100	—	250		I <sub>C</sub> = 150mA, V <sub>CE</sub> = 2V
Collector-Emitter Saturation Voltage	V <sub>CE(SAT)</sub>	—	—	500	mV	I <sub>C</sub> = 500mA, I <sub>B</sub> = 50mA
Base-Emitter Voltage	V <sub>BE(ON)</sub>	—	—	1	V	I <sub>C</sub> = 500mA, V <sub>CE</sub> = 2V
<b>Small Signal Characteristics</b>						
Transition Frequency	f <sub>T</sub>	—	200	—	MHz	I <sub>C</sub> = 50mA, V <sub>CE</sub> = 5V, f = 100MHz

- Notes:
1. No purposefully added lead.
  2. Diodes Inc.'s "Green" policy can be found on our website at [http://www.diodes.com/products/lead\\_free/index.php](http://www.diodes.com/products/lead_free/index.php).
  3. Device mounted on FR-4 PCB, pad layout as shown on page 4 or in Diodes Inc. suggested pad layout document AP02001, which can be found on our website at <http://www.diodes.com/datasheets/ap02001.pdf>.
  4. Measured under pulsed conditions. Pulse width = 300μs. Duty cycle ≤ 2%

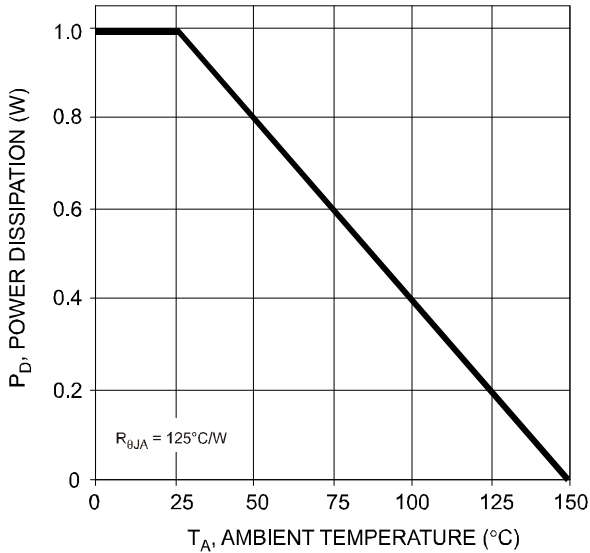

Fig. 1 Power Dissipation vs. Ambient Temperature

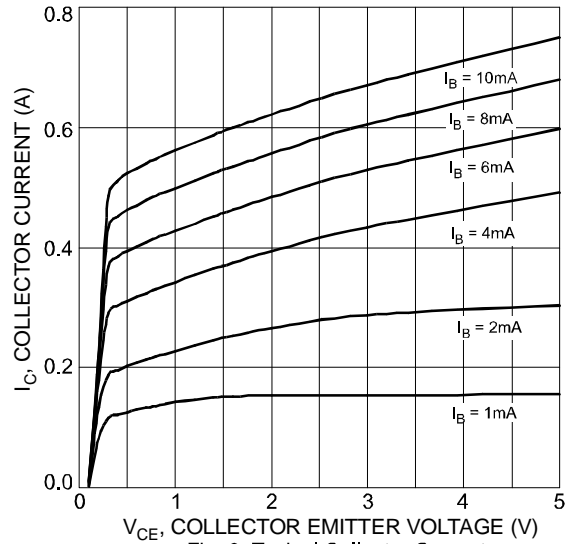

Fig. 2 Typical Collector Current vs. Collector Emitter Voltage

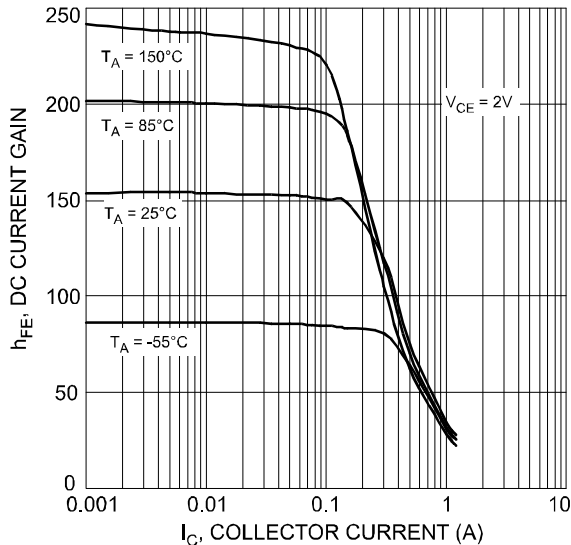

Fig. 3 Typical DC Current Gain vs. Collector Current

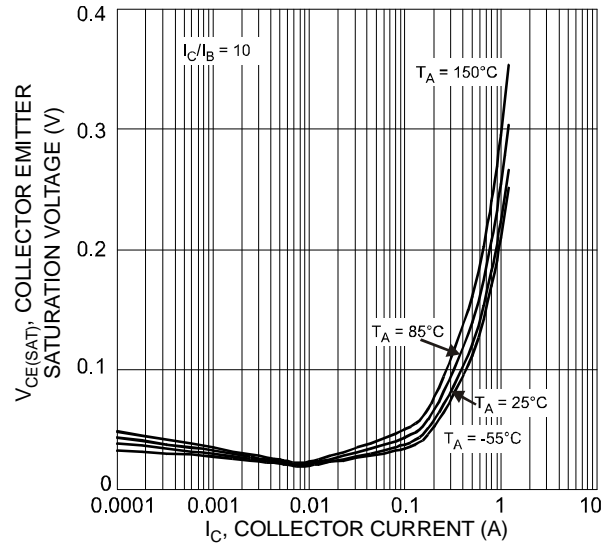

Fig. 4 Typical Collector Emitter Saturation Voltage vs. Collector Current

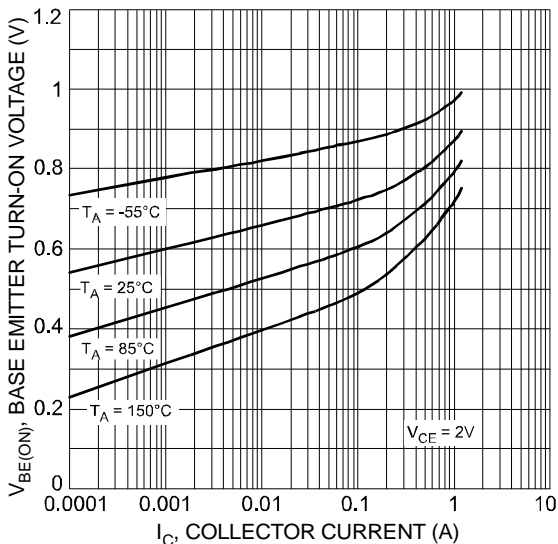

Fig. 5 Typical Base Emitter Turn-On Voltage vs. Collector Current

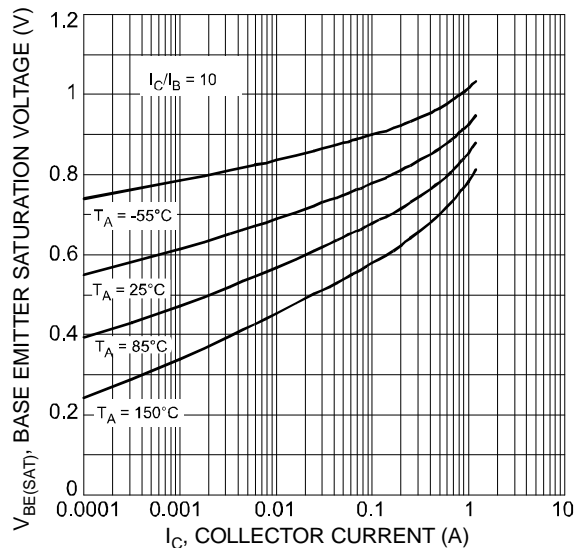

Fig. 6 Typical Base Emitter Saturation Voltage vs. Collector Current

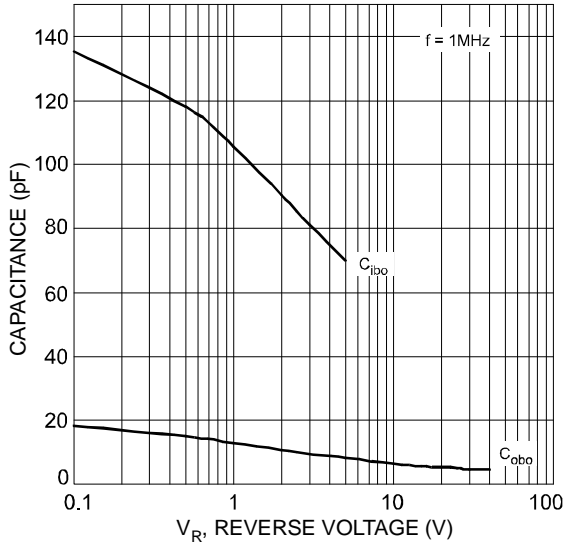

Fig. 7 Typical Capacitance Characteristics

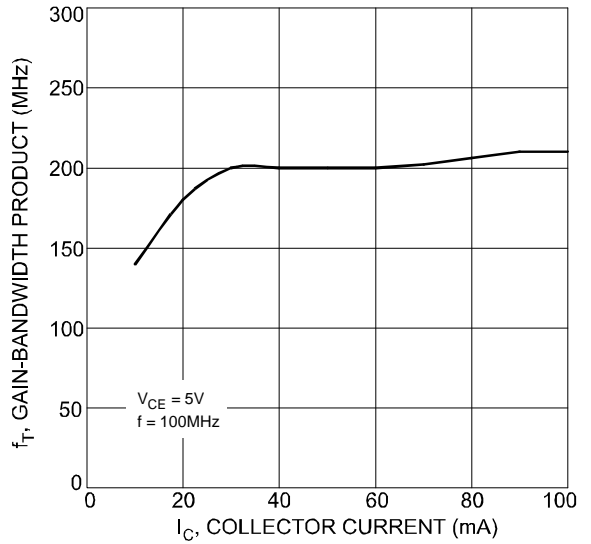

Fig. 8 Typical Gain-Bandwidth Product vs. Collector Current

**Ordering Information (Note 5)**

Device	Packaging	Shipping
DCP54-13	SOT-223	2500/Tape & Reel
DCP54-16-13	SOT-223	2500/Tape & Reel

Notes: 5. For packaging details, go to our website at <http://www.diodes.com/ap02007.pdf>.

**Marking Information**

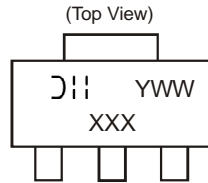

D = Manufacturer's code marking  
 XXX = Product type marking code Ex: N14 = DCP54  
 N14-16 = DCP54-16  
 YWW = Date code marking  
 Y = Last digit of year ex: 7 = 2007  
 WW = Week code 01 - 52

**Package Outline Dimensions**

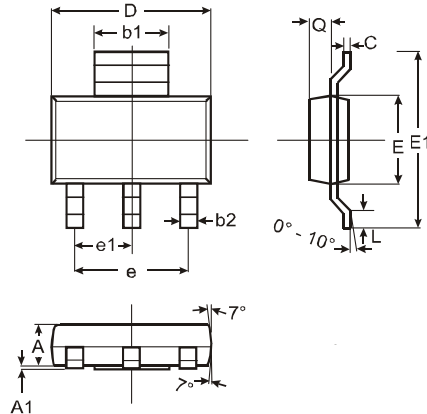

SOT-223			
Dim	Min	Max	Typ
A	1.55	1.65	1.60
A1	0.010	0.15	0.05
b1	2.90	3.10	3.00
b2	0.60	0.80	0.70
C	0.20	0.30	0.25
D	6.45	6.55	6.50
E	3.45	3.55	3.50
E1	6.90	7.10	7.00
e	—	—	4.60
e1	—	—	2.30
L	0.85	1.05	0.95
Q	0.84	0.94	0.89
All Dimensions in mm			

**Suggested Pad Layout: (Based on IPC-SM-782)**

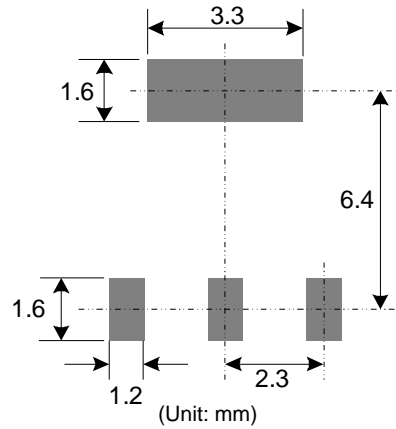

**IMPORTANT NOTICE**

Diodes Incorporated and its subsidiaries reserve the right to make modifications, enhancements, improvements, corrections or other changes without further notice to any product herein. Diodes Incorporated does not assume any liability arising out of the application or use of any product described herein; neither does it convey any license under its patent rights, nor the rights of others. The user of products in such applications shall assume all risks of such use and will agree to hold Diodes Incorporated and all the companies whose products are represented on our website, harmless against all damages.

**LIFE SUPPORT**

Diodes Incorporated products are not authorized for use as critical components in life support devices or systems without the expressed written approval of the President of Diodes Incorporated.