



Features

- Lead free as standard - RoHS compliant*
- Telcordia GR1089 (Intra-Building)
- Protects 2 lines
- ESD protection > 40 kV
- Low Capacitance 6 pF

Applications

- T1/E1 & T3/E3 line cards
- ISDN U-Interface and S/T Interface
- xDSL
- Ethernet – 10/100 Base T

CDNBS08-PLC03-6 Steering Diode/TVS Array Combo

General Information

The markets of portable communications, computing and video equipment are challenging the semiconductor industry to develop increasingly smaller electronic components.

Bourns offers Steering Diode/Transient Voltage Suppressor Array combination diodes for surge and ESD protection applications in an 8 lead narrow body SOIC package size format.

The Bourns® device will meet IEC 61000-4-2 (ESD), IEC 61000-4-4 (EFT) and IEC 61000-4-5 (Surge) requirements.

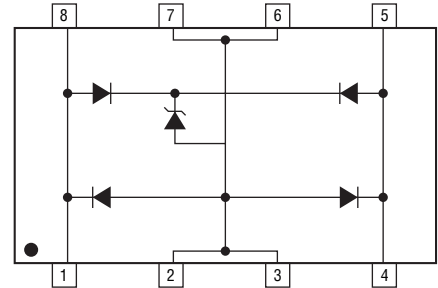

Electrical Characteristics (@ T_A = 25 °C Unless Otherwise Noted)

Parameter	Symbol	Min.	Nom.	Max.	Unit
Capacitance @ 0 V 1 MHz ¹	C _{j(SD)}		16	20	pF
Capacitance @ 0 V 1 MHz ²	C _{j(SD)}		6	8	pF
Working Peak Voltage	V _{WM}			6	V
Min. Breakdown Voltage I @ 1 mA	V _{BR}	6.8			V
Max. Clamping Voltage @ 8/20 μs V _C @ IPP ^{3,4}	V _F			20.0 V @ 100.0 A	V
Max. Leakage Current @ V _{WM}	I _D			25	μA
ESD Protection: IEC 61000-4-2 Contact Discharge Air Discharge		±8 ±15			kV kV
Peak Pulse Power (tp = 8/20 μs) ⁵	P _{PP}			2000	W
EFT Protection: IEC61000-4-4 @ 5/50 ns		40			A
Surge Protection: IEC61000-4-5 @ 8/20 μs L4 (Line-Gnd) L4 (Line-Line)		95 48			A A
Surge Protection: Telcordia GR1089 (Intra-Building) @ 2/10 μs		100			A

Notes:

1. Measured between I/O pins and ground (pin 1 or 2).
2. Measured between I/O pins (pins 1 to 4).
3. See Pulse Wave Form. For an 8/20 μs waveform, apply positive pulse to pin 1 to 8 to pin 2 or 3 (ground).
4. Measured between pin 1 or 8 to pin 2 or 3; pin 1 or 8 to pin 4 or 5.
5. See Peak Pulse Power vs. Pulse Time.

Thermal Characteristics (@ T_A = 25 °C Unless Otherwise Noted)

Parameter	Symbol	Min.	Nom.	Max.	Unit
Junction Temperature Range	T _J	-55	+25	+150	°C
Storage Temperature Range	T _{STG}	-55	+25	+150	°C

*RoHS Directive 2002/95/EC Jan 27 2003 including Annex
Specifications are subject to change without notice.
Customers should verify actual device performance in their specific applications.

CDNBS08-PLC03-6 Steering Diode/TVS Array Combo



Product Dimensions

This is a molded JEDEC narrow body SO-8 package with lead free 100 % Sn plating on the lead frame. It weighs approximately 15 mg and has a flammability rating of UL 94V-0.

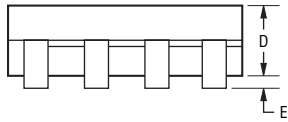
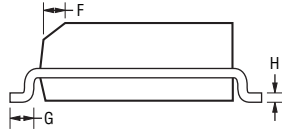
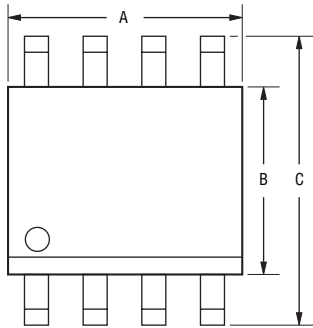

DIMENSIONS = $\frac{\text{MILLIMETERS}}{\text{(INCHES)}}$

Dimensions	
A	$\frac{4.80 - 5.00}{(0.189 - 0.196)}$
B	$\frac{3.80 - 4.00}{(0.150 - 0.157)}$
C	$\frac{5.80 - 6.20}{(0.229 - 0.244)}$
D	$\frac{1.35 - 1.75}{(0.054 - 0.068)}$
E	$\frac{0.10 - 0.25}{(0.004 - 0.008)}$
F	$\frac{0.25 - 0.50}{(0.010 - 0.019)}$
G	$\frac{0.40 - 1.250}{(0.016 - 0.049)}$
H	$\frac{0.18 - 0.25}{(0.007 - 0.009)}$

Recommended Footprint

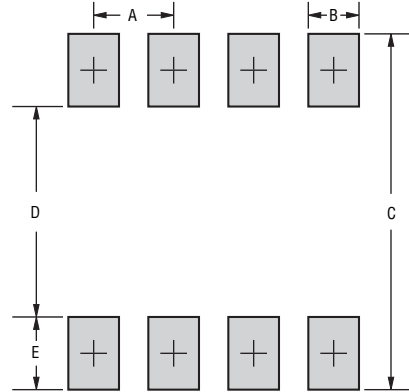

Dimensions	
A	$\frac{1.143 - 1.397}{(0.045 - 0.055)}$
B	$\frac{0.635 - 0.889}{(0.025 - 0.035)}$
C	$\frac{6.223}{(0.245)}$ Min.
D	$\frac{3.937 - 4.191}{(0.155 - 0.165)}$
E	$\frac{1.016 - 1.27}{(0.040 - 0.050)}$

Typical Part Marking

CDNBS08-PLC03-6PBA

How To Order

Common Code _____ **CD NBS08 - PLC03 - 6**
 Chip Diode _____
 Package _____
 • NBS08 = Narrow Body SOIC8 Package
 Model _____
 PLC03 = Model Number
 Working Peak Voltage _____
 6 = 6 V_{WM} (Volts)

CDNBS08-PLC03-6 Steering Diode/TVS Array Combo



Performance Graphs

Peak Pulse Power vs Pulse Time

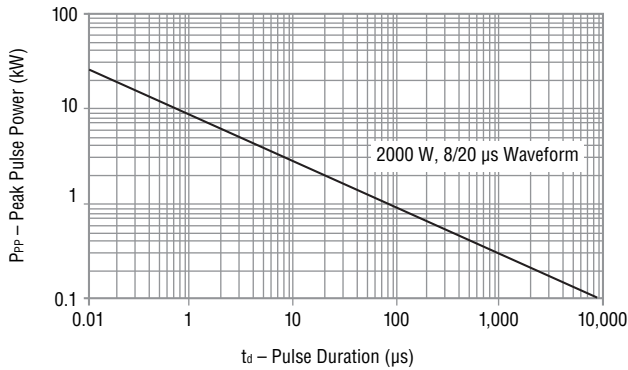

Pulse Wave Form

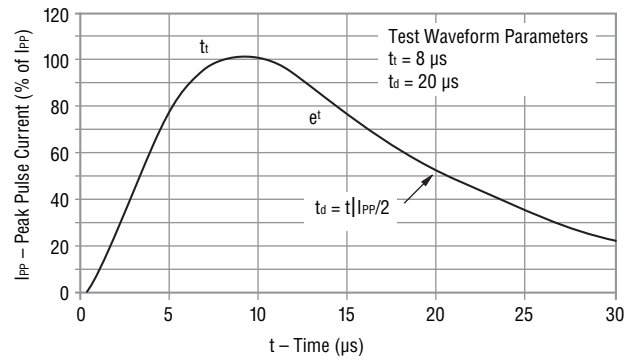

Block Diagram

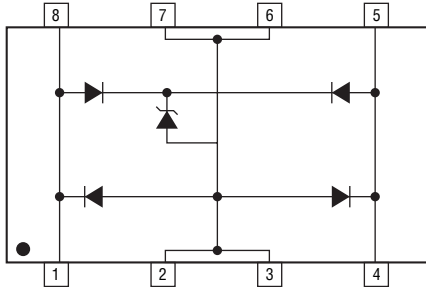

Power Derating Curve

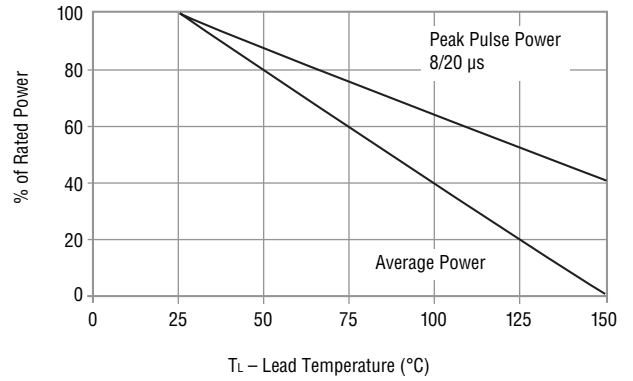

Device Pinout

Pin	Function
1	I/O 1
2	GND
3	GND
4	I/O 2
5	I/O 2
6	GND
7	GND
8	I/O 1

Specifications are subject to change without notice. Customers should verify actual device performance in their specific applications.

CDNBS08-PLC03-6 Steering Diode/TVS Array Combo

BOURNS®

Packaging Specifications

The product will be dispensed in Tape and Reel format (see diagram below).

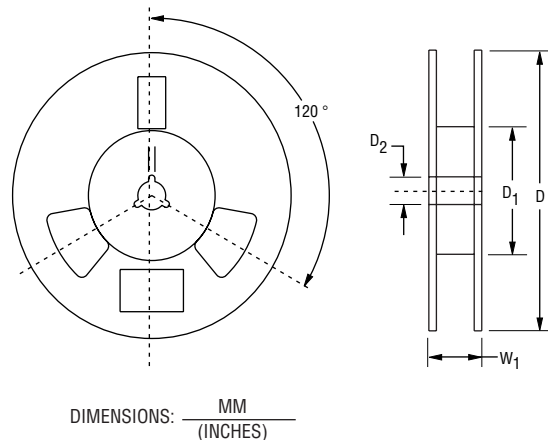
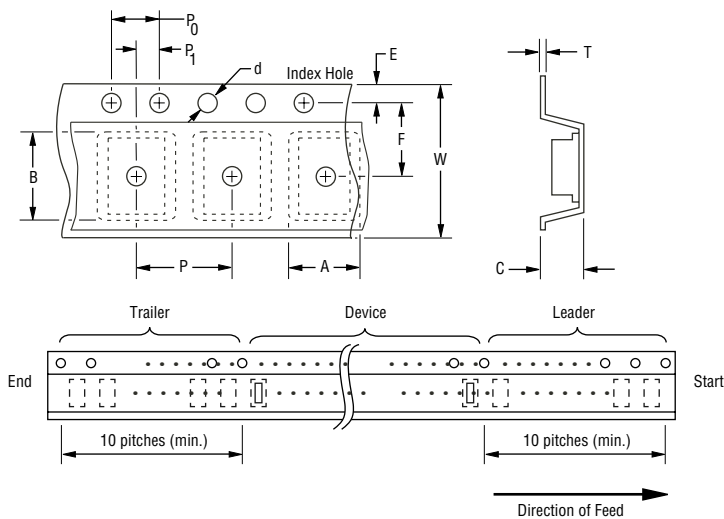

Devices are packed in accordance with EIA standard RS-481-A.

Item	Symbol	NSOIC 8L
Carrier Width	A	$\frac{6.7 \pm 0.10}{(0.264 \pm 0.004)}$
Carrier Length	B	$\frac{5.5 \pm 0.10}{0.217 \pm 0.004}$
Carrier Depth	C	$\frac{2.10 \pm 0.10}{0.083 \pm 0.004}$
Sprocket Hole	d	$\frac{1.55 \pm 0.05}{(0.061 \pm 0.002)}$
Reel Outside Diameter	D	$\frac{330}{(12.992)}$
Reel Inner Diameter	D ₁	$\frac{80.0}{(3.1500)}$ MIN.
Feed Hole Diameter	D ₂	$\frac{13.0 \pm 0.20}{(0.512 \pm 0.008)}$
Sprocket Hole Position	E	$\frac{1.75 \pm 0.10}{(0.069 \pm 0.004)}$
Punch Hole Position	F	$\frac{3.50 \pm 0.05}{(0.138 \pm 0.002)}$
Punch Hole Pitch	P	$\frac{8.00 \pm 0.10}{(0.315 \pm 0.004)}$
Sprocket Hole Pitch	P ₀	$\frac{4.00 \pm 0.10}{(0.157 \pm 0.004)}$
Embossment Center	P ₁	$\frac{2.00 \pm 0.05}{(0.079 \pm 0.002)}$
Overall Tape Thickness	T	$\frac{0.20 \pm 0.10}{(0.008 \pm 0.004)}$
Tape Width	W	$\frac{12.00 \pm 0.20}{(0.472 \pm 0.008)}$
Reel Width	W ₁	$\frac{18.4}{(0.724)}$ MAX.
Quantity per Reel	-	2500



Asia-Pacific:
Tel: +886-2 2562-4117 • Fax: +886-2 2562-4116

Europe:
Tel: +41-41 768 5555 • Fax: +41-41 768 5510

The Americas:
Tel: +1-951 781-5500 • Fax: +1-951 781-5700

www.bourns.com

REV. 09/09

Specifications are subject to change without notice. Customers should verify actual device performance in their specific applications.