

PLEASE CHECK WWW.MOLEX.COM FOR LATEST PART INFORMATION

Part Number: **0366380009**
Status: **Active**
Overview: cmc connectors
Description: 2.50mm (.098"), 3.50mm (.138") CMC Header, Right Angle, 48 Position, 36 loaded, 1 Port, Brown, Lead-free

Documents:

[3D Model](#) [RoHS Certificate of Compliance \(PDF\)](#)
[Drawing \(PDF\)](#)

General

Product Family	PCB Headers
Series	<u>36638</u>
Application	Wire-to-Board
Overview	<u>cmc connectors</u>
Product Name	CMC

Physical

Breakaway	No
Circuits (Loaded)	36
Circuits (maximum)	48
Circuits Detail	6 x 1.5mm & 30 x 0.635mm terminals
Color - Resin	Black
Durability (mating cycles max)	20
First Mate / Last Break	Yes
Glow-Wire Compliant	No
Guide to Mating Part	Yes
Keying to Mating Part	Yes
Lock to Mating Part	Yes
Mated Height (in)	0.264 In
Mated Height (mm)	6.70 mm
Material - Metal	Brass
Material - Plating Mating	Tin
Material - Plating Termination	Tin
Material - Resin	Polyester
Number of Rows	4
Orientation	Right Angle
PC Tail Length (in)	0.114 In
PC Tail Length (mm)	2.90 mm
PCB Locator	No
PCB Retention	None
PCB Thickness Recommended (in)	0.079 In
PCB Thickness Recommended (mm)	2.00 mm
Packaging Type	Tray
Pitch - Mating Interface (in)	0.098 In, 0.138 In, 0.146 In
Pitch - Mating Interface (mm)	2.50 mm, 3.50 mm, 3.70 mm
Pitch - Term. Interface (in)	0.098 In, 0.138 In, 0.146 In
Pitch - Term. Interface (mm)	2.50 mm, 3.50 mm, 3.70 mm
Plating min: Mating (µin)	160
Plating min: Mating (µm)	4
Plating min: Termination (µin)	160
Plating min: Termination (µm)	4
Polarized to Mating Part	Yes
Polarized to PCB	Yes
Shrouded	Closed Ends
Stackable	No

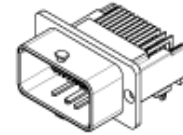

Series
image - Reference only

EU RoHS

ELV and RoHS Compliant
REACH SVHC
 Not Reviewed
Halogen-Free
Status

China RoHS



Not Reviewed

Need more information on product environmental compliance?

Email productcompliance@molex.com
 For a multiple part number RoHS Certificate of Compliance, [click here](#)

Please visit the [Contact Us](#) section for any non-product compliance questions.

Search Parts in this Series

36638Series

Mates With

CMC Connectors 643201319 , 643203319 ,

Use With

CMC Connectors 643201319 , 643203319 , 643202319 , 643204319. CMC CP Terminals Terminals 64322 , 64323. CMC Blind Plug for CP Terminal 64325. Wire Cap 643191201

Surface Mount Compatible (SMC)	No
Temperature Range - Operating	-40°C to +100°C
Termination Interface: Style	Through Hole

Electrical

Current - Maximum per Contact	8A
Voltage - Maximum	250V

Material Info**Reference - Drawing Numbers**

Packaging Specification	PK-36638-001, PK-36638-002
Sales Drawing	SD-36638-002

This document was generated on 05/24/2010

PLEASE CHECK WWW.MOLEX.COM FOR LATEST PART INFORMATION

RoHS COMPLIANT

4	1	GRID PLATE	PBT 30% GLASS FILLED	BLACK
3	1	HOUSING		BLACK
2	2	1.5	CuZn30	NICKEL UNDERCOAT: 1.3µM TO 2.2µM
1	10	0.64	CuZn30	MATTE TIN OVERCOAT: 4µM TO 5µM
SL NO.	QTY	DESIGNATION	MATERIAL	FINISH

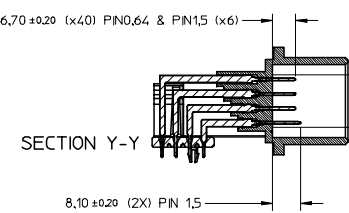
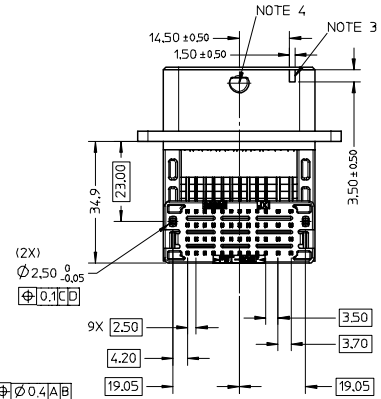
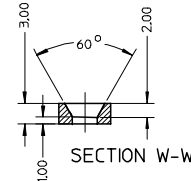
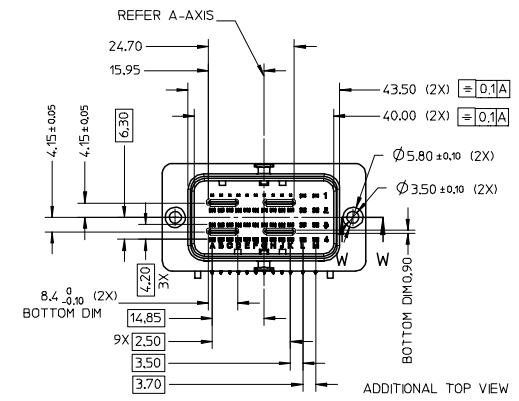
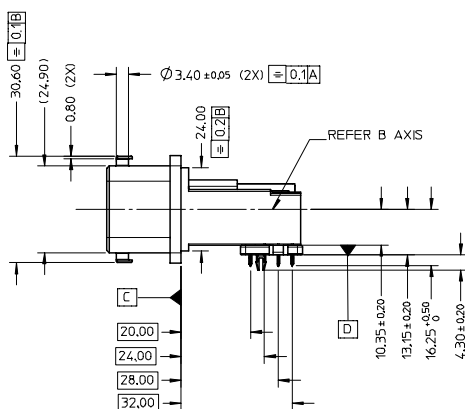
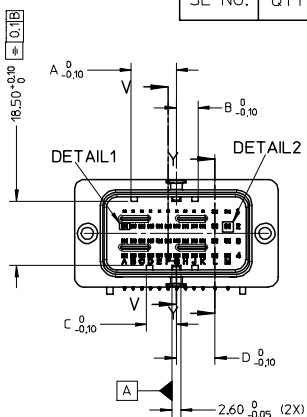
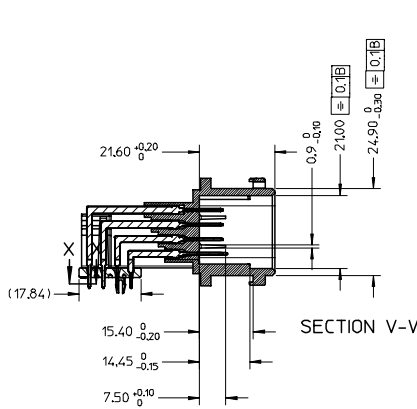
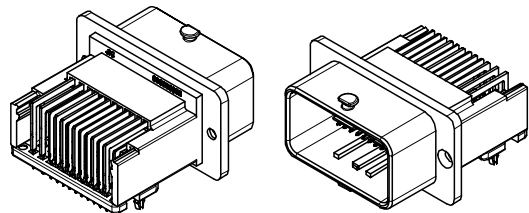

D	6.30	12.90
C	8.50	12.90
B	6.30	10.70
A	12.90	8.50
DIMENSION	366380002	366380003
	366380004	366380005
	366380006	366380007
	366380008	366380009
	(BLACK)	(BROWN)
MOLEX PN		

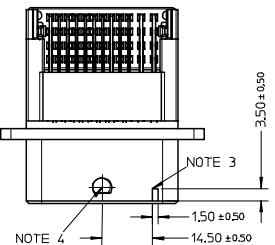
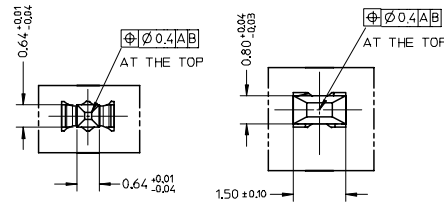

ENTER DESCRIPTION EIC NO: 12008-0132 DRWNR: RANGAPPAO1 2007/09/20 CHKDR: PRASAD 2007/09/21 APPR: KRASAD 2007/09/21 REV:	QUALITY SYMBOLS ▽=0 ▽=0	GENERAL TOLERANCES (UNLESS SPECIFIED) <table border="1"> <tr> <th></th> <th>mm</th> <th>INCH</th> </tr> <tr> <td>4 PLACES</td> <td>±---</td> <td>±---</td> </tr> <tr> <td>3 PLACES</td> <td>±---</td> <td>±---</td> </tr> <tr> <td>2 PLACES</td> <td>±0.1</td> <td>±---</td> </tr> <tr> <td>1 PLACE</td> <td>±0.2</td> <td>±---</td> </tr> <tr> <td colspan="3">ANGULAR ± 1 °</td> </tr> </table>		mm	INCH	4 PLACES	±---	±---	3 PLACES	±---	±---	2 PLACES	±0.1	±---	1 PLACE	±0.2	±---	ANGULAR ± 1 °			DIMENSION STYLE MM ONLY	SCALE 1:1	DESIGN UNITS METRIC	THIRD ANGLE PROJECTION
		mm	INCH																					
	4 PLACES	±---	±---																					
	3 PLACES	±---	±---																					
	2 PLACES	±0.1	±---																					
1 PLACE	±0.2	±---																						
ANGULAR ± 1 °																								
			DRAWN BY: ROOPESH DATE: 08/05/2006	CHECKED BY: DINESH DATE: 08/05/2006	TITLE CMC HEADER 48/48WAY AND 48/36WAY T3 INTERFACE																			
			APPROVED BY: DINESH DATE: 08/05/2006	MOLEX INCORPORATED																				
		DRAFT WHERE APPLICABLE MUST REMAIN WITHIN DIMENSIONS	SEE TABLE 'A'	MATERIAL NO. DOCUMENT NO. SD-36638-002	SHEET NO. 1 OF 3																			
THIS DRAWING CONTAINS INFORMATION THAT IS PROPRIETARY TO MOLEX INCORPORATED AND SHOULD NOT BE USED WITHOUT WRITTEN PERMISSION																								

TABLE 'A'

ASSY CMC HEADER	ASSY CMC 48 WAY 48 CKT	366380002	BLACK	AVAILABLE (SEE VIEW 'A')	1.6	1.5	L1 & M1,L2 & M2 L3 & M3,L4 & M4
		366380003	BROWN				
		366380004	BLACK	NOT AVAILABLE (SEE VIEW 'B')	0.8/1.6/2.0	0.64	
		366380005	BROWN				
ASSY CMC 48 WAY 36 CKT		366380006	BLACK	AVAILABLE (SEE VIEW 'A')	1.6	1.5	L2 & M2 L3 & M3,L4 & M4
		366380007	BROWN				
		366380008	BLACK	NOT AVAILABLE (SEE VIEW 'B')	0.8/1.6/2.0	0.64	
		366380009	BROWN				
DESIGNATION	MOLEX PN	CODING COLOUR	PCB LOCKING ON GRID PLATE	FOR PCB OF THICKNESS	PIN	CAVITIES NUMBER	

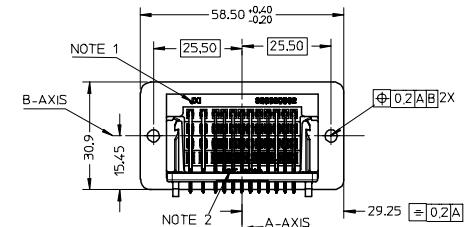
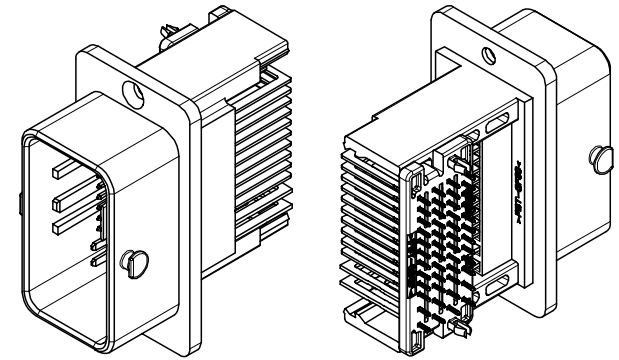

ADDITIONAL BACK VIEW

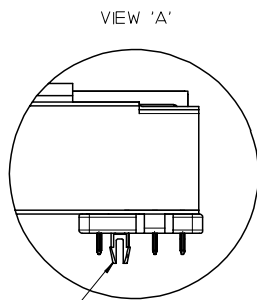

VIEW 'A'
GRID PLATE WITH
PCB LOCKING

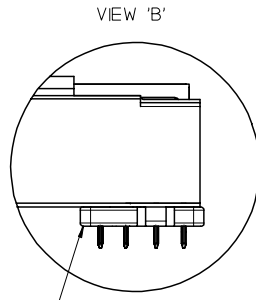

VIEW 'B'
GRID PLATE WITHOUT
PCB LOCKING

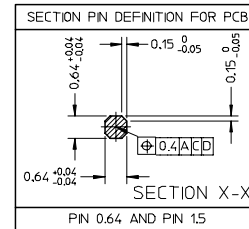

SECTION X-X
PIN 0.64 AND PIN 1.5

NOTES :

1. AREA FOR JXI AND MOLEX PART NUMBER REPRESENTATION
2. AREA FOR PLASTIC MATERIAL >PBT-30%GF< DESCRIPTION
3. PAINT WITH WHITE COLOR(RoHS COMPLIANT) AT SPECIFIED TWO AREAS
4. PAINT WITH BROWN COLOR(RoHS COMPLIANT) AT SPECIFIED AREA ON BOTH SIDE FOR PN: 366380003,366380005, 366380007,366380009.
5. PART TO MEET SOLDERABILITY SPEC SMES-152
6. PACKAGING SPECIFICATION PK-36638-002

ENTER DESCRIPTION EIC NO: 12008-0132 DRW:NRANGAPPA01 2007/09/20 CHK:KPRASAD 2007/09/21 APPR:KPRASAD 2007/09/21 REV:	QUALITY SYMBOLS ▽=0 ▽=0	GENERAL TOLERANCES (UNLESS SPECIFIED) <table border="1"> <tr> <th></th> <th>mm</th> <th>INCH</th> </tr> <tr> <td>4 PLACES</td> <td>± ---</td> <td>± ---</td> </tr> <tr> <td>3 PLACES</td> <td>± ---</td> <td>± ---</td> </tr> <tr> <td>2 PLACES</td> <td>± 0.1</td> <td>± ---</td> </tr> <tr> <td>1 PLACE</td> <td>± 0.2</td> <td>± ---</td> </tr> </table> ANGULAR ± 1 °		mm	INCH	4 PLACES	± ---	± ---	3 PLACES	± ---	± ---	2 PLACES	± 0.1	± ---	1 PLACE	± 0.2	± ---	DIMENSION STYLE: DIMENSIONAL DATE: 08/05/2006 SCALE: 1:1 DESIGN UNITS: METRIC THIRD ANGLE PROJECTION TITLE: CMC HEADER 48 WAY AND 48/36WAY T3 INTERFACE ORDER CODE: SD-36638-002 MOLEX INCORPORATED MATERIAL NO.: DOCUMENT NO.: SHEET NO.: 2 OF 3
		mm	INCH															
4 PLACES	± ---	± ---																
3 PLACES	± ---	± ---																
2 PLACES	± 0.1	± ---																
1 PLACE	± 0.2	± ---																
DRAFT WHERE APPLICABLE MUST REMAIN WITHIN DIMENSIONS		SEE TABLE 'A'	THIS DRAWING CONTAINS INFORMATION THAT IS PROPRIETARY TO MOLEX INCORPORATED AND SHOULD NOT BE USED WITHOUT WRITTEN PERMISSION															

INTERFACE PCB DEFINITION (SOLDER SIDE)

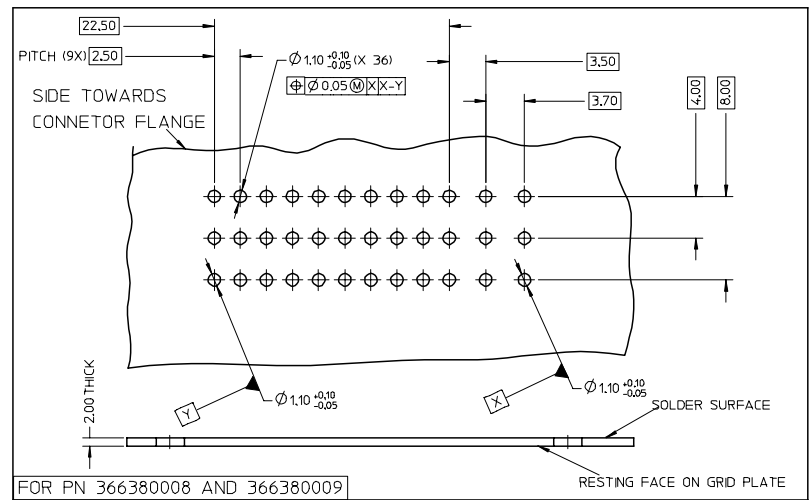
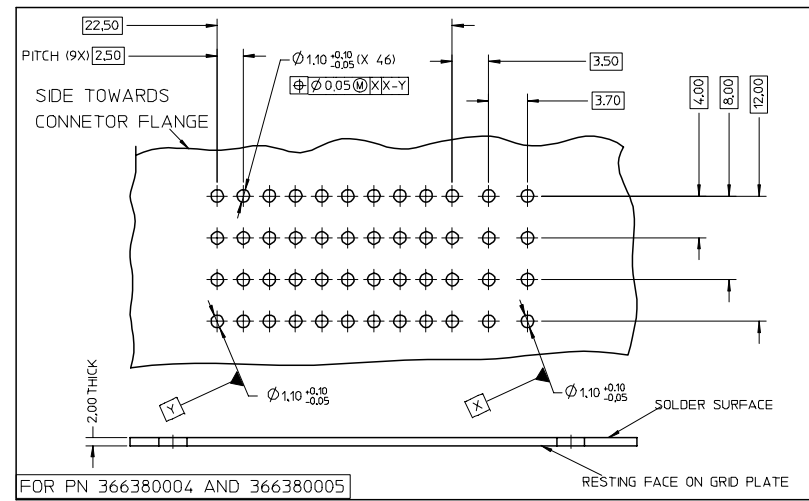
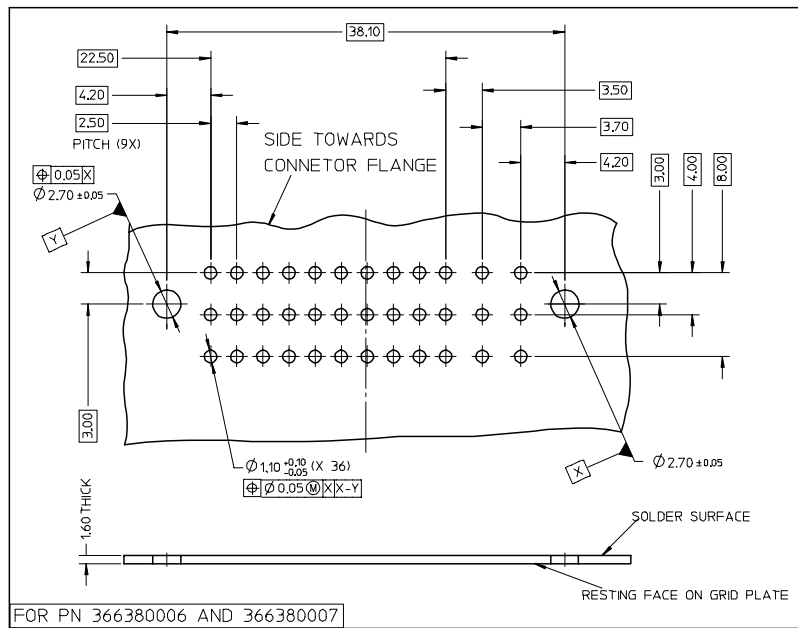
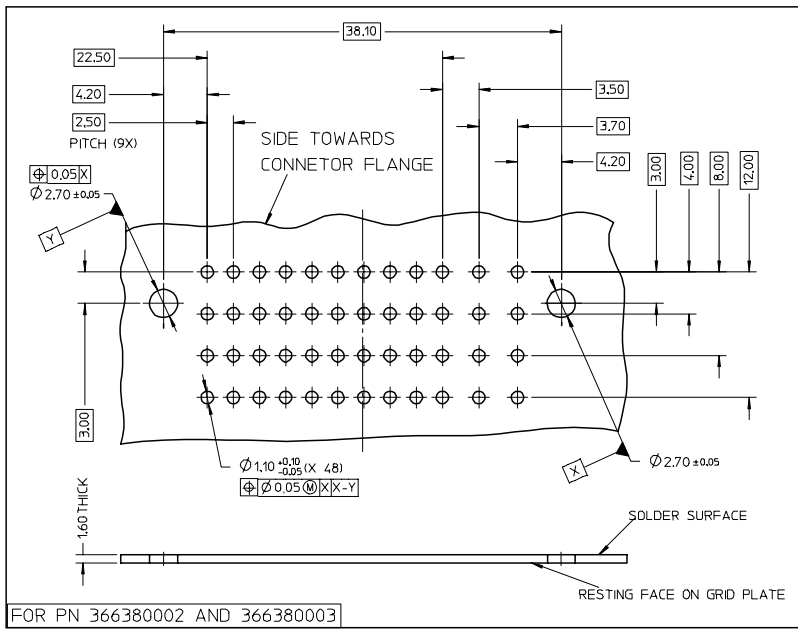

ENTER DESCRIPTION EIC NO.: I2008-0132 DRAWN/RANGAPPAO1 2007/09/20 CHKD/KPRASAD 2007/09/21 APPR/KPRASAD 2007/09/21	QUALITY SYMBOLS	GENERAL TOLERANCES (UNLESS SPECIFIED)	DIMENSION STYLE	SCALE	DESIGN UNITS	THIRD ANGLE PROJECTION
	$\nabla=0$ $\nabla=0$	mm INCH 4 PLACES ± --- ± --- 3 PLACES ± --- ± --- 2 PLACES ± 0.1 ± --- 1 PLACE ± 0.2 ± --- ANGULAR ± 1 °	MM ONLY	1:1	PITCH METRIC	
	DRAWN BY DATE ROOPESH 08/05/2006 CHECKED BY DATE DINESH 08/05/2006 APPROVED BY DATE DINESH 08/05/2006	TITLE CMC HEADER 48/48WAY AND 48/36WAY T3 INTERFACE				
	MATERIAL NO. DOCUMENT NO.	SEE TABLE 'A' DRAFT WHERE APPLICABLE MUST REMAIN WITHIN DIMENSIONS		MOLEX INCORPORATED SD-36638-002		SHEET NO. 3 OF 3