

PLEASE CHECK WWW.MOLEX.COM FOR LATEST PART INFORMATION

Part Number: [0022011022](#)
Status: **Active**
Overview: [kk](#)
Description: 2.50mm (.098") Pitch KK® Wire-to-Board Housing, Female, Friction Lock, for 2759/5159 Crimp Terminals, 2 Circuits

Documents:

3D Model	Product Specification PS-5051-001 (PDF)
Drawing (PDF)	Product Specification PS-5051-002 (PDF)
Product Specification PS-5045-001 (PDF)	Product Specification PS-5051-003 (PDF)
Product Specification PS-5045-002 (PDF)	Product Specification PS-5051-004 (PDF)
Product Specification PS-5045-003 (PDF)	Product Specification PS-5102-004 (PDF)
Product Specification PS-5045-004 (PDF)	RoHS Certificate of Compliance (PDF)
Product Specification PS-5046-004 (PDF)	

Agency Certification

CSA	LR19980
TUV	R72090224
UL	E29179

General

Product Family	Crimp Housings
Series	5051
Overview	kk
Product Name	KK®

Physical

Circuits (maximum)	2
Color - Resin	Natural
Flammability	94V-0
Gender	Female
Glow-Wire Compliant	No
Material - Resin	Nylon
Number of Rows	1
Packaging Type	Bag
Panel Mount	No
Pitch - Mating Interface (in)	0.098 In
Pitch - Mating Interface (mm)	2.50 mm
Stackable	No
Temperature Range - Operating	-40°C to +105°C

Material Info

Old Part Number	5051-02
-----------------	---------

Reference - Drawing Numbers

Packaging Specification	SPK-5051-001
Product Specification	PS-5045-001, PS-5045-002, PS-5045-003, PS-5045-004, PS-5046-004, PS-5051-001, PS-5051-002, PS-5051-003, PS-5051-004, PS-5102-004
Sales Drawing	SD-5051-001

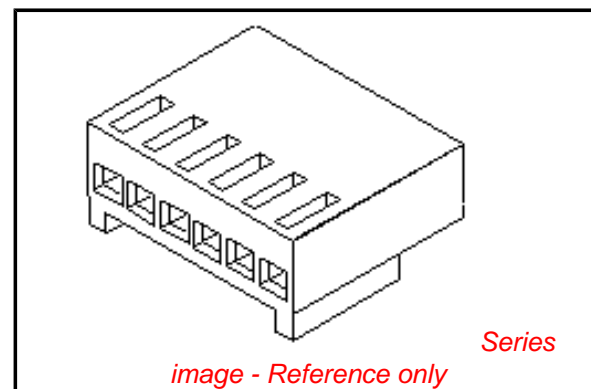

EU RoHS

ELV and RoHS Compliant
REACH SVHC
Contains SVHC: No
Halogen-Free
Status

China RoHS



Not Halogen-Free

Need more information on product environmental compliance?

Email productcompliance@molex.com
 For a multiple part number RoHS Certificate of Compliance, [click here](#)

Please visit the [Contact Us](#) section for any non-product compliance questions.

Search Parts in this Series

[5051Series](#)

Mates With

[5045](#) Vertical Header, [5046](#) Right Angle Header

Use With

[2759](#) , [5159](#)

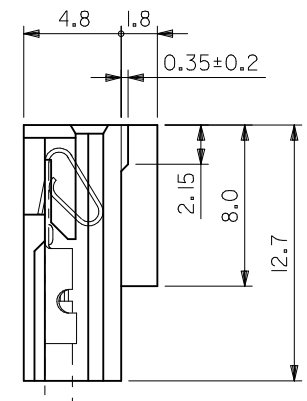
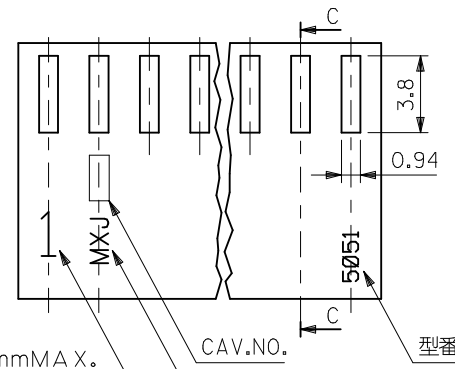
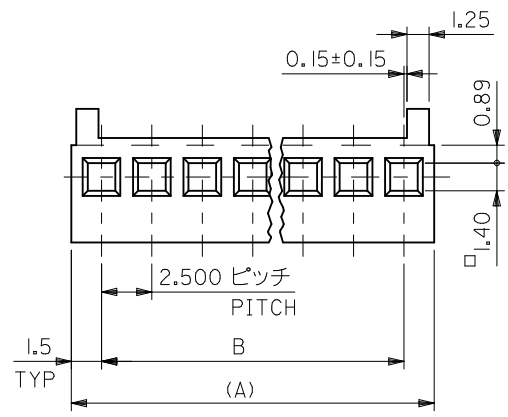

- 注) NOTE.
1. そりは長さ25.4mmに対して0.2mmMAX X. CAMBER MUST BE WITHIN 0.2 MAX. PER 25.4.
 2. () 寸法は参考値 DIMENSION SHOWN IN () ARE REFERENCE.
 3. サーキットNO. 1のみ表示 但し2極の場合はMX-Jマーク側が1となる WHEN 2 CIRCUITS HOUSING TRADE MARK SIDE IN NO.1 CIRCUIT.

CAV.NO. 型番 ENG.NO.
 サーキットNO. (注3参照) CIRCUIT NO. (1 ONLY) SEE NOTE 3.

ターミナル#2759又は#5159
 TERMINAL #2759 OR #5159

MT*L. NYLON 66(94V-0)

5051-16	22-01-1162	16	37.50±0.25	40.50
↑ -15	↑ -1152	15	35.00±0.20	38.00
-14	-1142	14	32.50±0.20	35.50
-13	-1132	13	30.00±0.20	33.00
-12	-1122	12	27.50±0.20	30.50
-11	-1112	11	25.00±0.15	28.00
-10	-1102	10	22.50±0.15	25.50
-09	-1092	9	20.00±0.15	23.00
-08	-1082	8	17.50±0.15	20.50
-07	-1072	7	15.00±0.15	18.00
-06	-1062	6	12.50±0.10	15.50
-05	-1052	5	10.00±0.10	13.00
-04	-1042	4	7.50±0.10	10.50
↓ -03	↓ -1032	3	5.00±0.10	8.00
5051-02	22-01-1022	2	2.50±0.08	5.50
MATERIAL NO.	PART NO.	極数 N	B	(A)
				MODEL NO. 5051-N

REVISED EC NO: J2010-1867 DRWRTS:SUROKA 2010/03/19 CHKD:THARUYAMA 2010/03/23 APPR:HIRATA 2010/03/23	GENERAL TOLERANCES (UNLESS SPECIFIED)		DIMENSION STYLE MM ONLY		SCALE 4:1	DESIGN UNITS METRIC	THIRD ANGLE PROJECTION	
	10 UNDER	±0.25	DRAWN BY K. KOHAMA	DATE '00/3/28	TITLE 2.50/(.098) CENTERS KK POLZG HSG			
	10 OVER 30 UNDER	±0.3	CHECKED BY T. YAMAGUCHI	DATE '00/3/30				
	30 OVER	±0.35	APPROVED BY M. FUKUSHIMA	DATE '00/3/30	MOLEX INCORPORATED			
ANGULAR ±3 °		MATERIAL NO.		DOCUMENT NO.				
DRAFT WHERE APPLICABLE MUST REMAIN WITHIN DIMENSIONS		SEE TABLE		SD-5051-001		1 OF 1		
		SIZE A3		THIS DRAWING CONTAINS INFORMATION THAT IS PROPRIETARY TO MOLEX INCORPORATED AND SHOULD NOT BE USED WITHOUT WRITTEN PERMISSION				