

**PLEASE CHECK WWW.MOLEX.COM FOR LATEST PART INFORMATION**

**Part Number:** [0750885000](#)  
**Status:** **Active**  
**Overview:** vhdm\_hsd  
**Description:** 2.00mm (.079") Pitch 5-Row VHDM-HSD™ Backplane Header, Polarizing Pin Module

**Documents:**

[Drawing \(PDF\)](#) [RoHS Certificate of Compliance \(PDF\)](#)

**General**

Product Family	Backplane Connectors
Series	75088
Application	Backplane
Application Tooling Documents	<a href="http://www.molex.com/pdm_docs/ats/TM-622010999.pdf">Tooling Manual</a>
Comments	No Keying Position
Component Type	PCB Header
Overview	<a href="#">vhdm_hsd</a>
Product Name	VHDM-HSD™
Style	N/A

**Physical**

Circuits (Loaded)	N/A
Circuits (maximum)	0
Durability (mating cycles max)	200
First Mate / Last Break	No
Guide to Mating Part	Yes
Keying to Mating Part	None
Number of Columns	10
Number of Pairs	Open Pin Field
Number of Rows	0
Orientation	Vertical
PC Tail Length (in)	0.000 In
PC Tail Length (mm)	0.00 mm
PCB Locator	Yes
PCB Retention	None
PCB Thickness Recommended (in)	0.173 In
PCB Thickness Recommended (mm)	4.40 mm
Packaging Type	Bag
Pitch - Mating Interface (in)	0.000 In
Pitch - Mating Interface (mm)	0.00 mm
Pitch - Term. Interface (in)	0.000 In
Pitch - Term. Interface (mm)	0.00 mm
Polarized to PCB	Yes
Stackable	No
Surface Mount Compatible (SMC)	No
Temperature Range - Operating	N/A

**Electrical**

Current - Maximum per Contact	N/A
Data Rate	5.0 Gbps
Shielded	No
Voltage - Maximum	N/A

**Material Info**

**Reference - Drawing Numbers**

Sales Drawing SD-75088-002

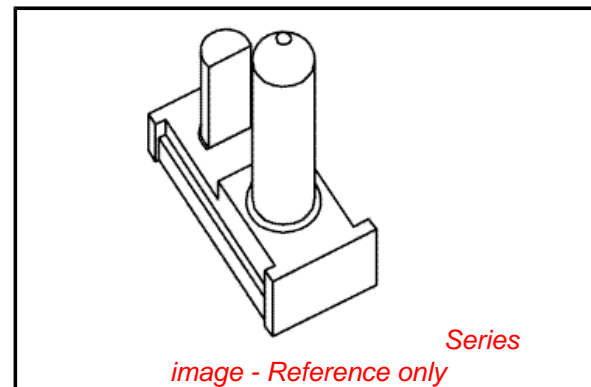

**EU RoHS**

**ELV and RoHS  
Compliant**  
**REACH SVHC**  
 Not Reviewed  
**Halogen-Free  
Status**  
 Not Reviewed

**China RoHS**



**Need more information on product  
environmental compliance?**

Email [productcompliance@molex.com](mailto:productcompliance@molex.com)  
 For a multiple part number RoHS Certificate of  
 Compliance, [click here](#)

Please visit the [Contact Us](#) section for any  
 non-product compliance questions.



**Search Parts in this Series**

75088Series

| VHDM-HSD is a trademark of Amphenol Corporation

This document was generated on 05/28/2010

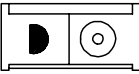
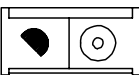
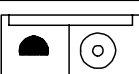
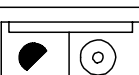
**PLEASE CHECK [WWW.MOLEX.COM](http://WWW.MOLEX.COM) FOR LATEST PART INFORMATION**

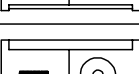
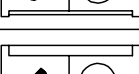
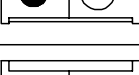
PART NUMBER	KEY POSITION
75088-5001	A 
75088-5002	B 
75088-5003	C 
75088-5004	D 
75088-5005	E 
75088-5006	F 
75088-5007	G 
75088-5008	H 
75088-5000	N/A 

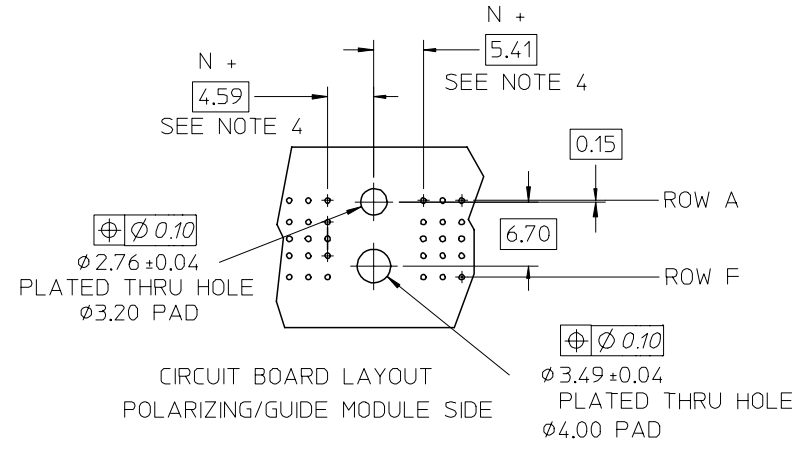
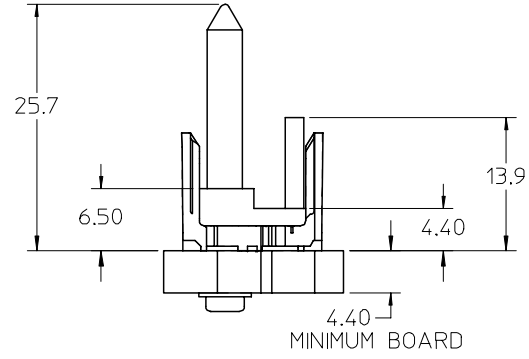
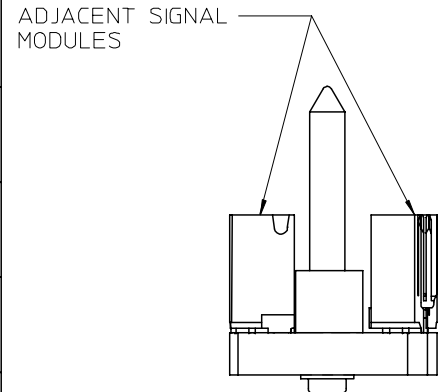
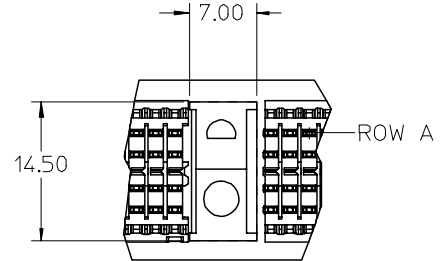

BILL OF MATERIAL 75088-500\*

ITEM	DESCRIPTION	QTY.
1	GUIDANCE AND POLARIZING MODULE	1
2	SCREW AND WASHER (PCB >4.4 - 9.0)	1

- NOTES:
- MATERIAL:  
ZINC ALLOY
  - THIS PART CONFORMS TO MOLEX  
PRODUCT SPECIFICATION PS-74031-999
  - PACKAGING:  
STANDARD BULK PACK, 100 PER BAG  
SCREWS PACKAGED SEPARATELY
  - "N" MUST BE 0 OR A MULTIPLE OF 2.00

ADDED 75088-5000 EC NO: UCP2004-0182 DRWN: JONIAK 2004/01/27 CHKD: LAURX 2004/01/27 APPR: SREED 2004/01/27	QUALITY SYMBOLS	GENERAL TOLERANCES (UNLESS SPECIFIED)	SCALE 2:1	DESIGN UNITS METRIC	THIRD ANGLE PROJECTION	REVISE ON CAD ONLY	
	▽ = 0	mm INCH	DIMENSION STYLE MM ONLY	TITLE	VHDM 5 ROW HSD BACKPLANE POLAR/GUIDE MODULE SALES ASSEMBLY		
	∇ = 0	4 PLACES ± --- ± --- 3 PLACES ± --- ± --- 2 PLACES ± --- ± --- 1 PLACE ± --- ± ---	ANGULAR ± ---°	DRAWN BY DATE JBINGHAM 02/02/13	CHECKED BY DATE NMARTIN 02/02/13	MATERIAL NO. DOCUMENT NO. SHEET NO. SEE CHART SD-75088-002 1 OF 1	
	∠	DRAFT WHERE APPLICABLE	MUST REMAIN WITHIN DIMENSIONS	APPROVED BY DATE CBIXLER 02/02/13	THIS DRAWING CONTAINS INFORMATION THAT IS PROPRIETARY TO MOLEX INCORPORATED AND SHOULD NOT BE USED WITHOUT WRITTEN PERMISSION		