

# N-CANNEL ENHANCEMENT MODE POWER MOSFET

## PRODUCT SUMMARY

Simple Drive Requirement  
 Lower On-resistance  
 Fast Switching Characteristic  
 RoHS Compliant

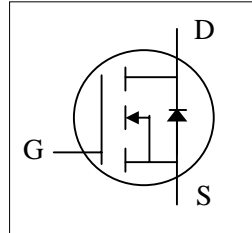

$BV_{DSS}$	75V
$R_{DS(ON)}$	5m $\Omega$
$I_D$	80A

## DESCRIPTION

The advanced power MOSFETs from Silicon Standard Corp. provide the designer with the best combination of fast switching, ruggedized device design, low on-resistance and cost-effectiveness.

The TO-220 package is universally preferred for all commercial-industrial power applications and suited for low voltage applications such as DC/DC converters.

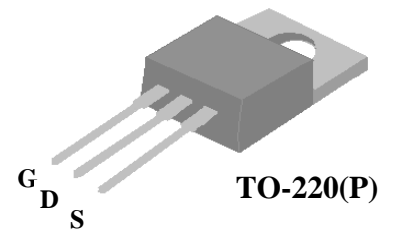

## ABSOLUTE MAXIMUM RATINGS

Symbol	Parameter	Rating	Units
$V_{DS}$	Drain-Source Voltage	75	V
$V_{GS}$	Gate-Source Voltage	$\pm 20$	V
$I_D@T_C=25^\circ C$	Continuous Drain Current, $V_{GS} @ 10V^3$	80	A
$I_D@T_C=100^\circ C$	Continuous Drain Current, $V_{GS} @ 10V$	70	A
$I_{DM}$	Pulsed Drain Current <sup>1</sup>	320	A
$P_D@T_C=25^\circ C$	Total Power Dissipation	300	W
	Linear Derating Factor	2	W/ $^\circ C$
$E_{AS}$	Single Pulse Avalanche Energy <sup>4</sup>	450	mJ
$T_{STG}$	Storage Temperature Range	-55 to 175	$^\circ C$
$T_J$	Operating Junction Temperature Range	-55 to 175	$^\circ C$

## THERMAL DATA

Symbol	Parameter	Value	Units
Rthj-c	Thermal Resistance Junction-case Max.	0.5	$^\circ C/W$
Rthj-a	Thermal Resistance Junction-ambient Max.	62	$^\circ C/W$

## ELECTRICAL CHARACTERISTICS

( $T_J=25^{\circ}\text{C}$  unless otherwise specified)

Symbol	Parameter	Test Conditions	Min.	Typ.	Max.	Units
$BV_{DSS}$	Drain-Source Breakdown Voltage	$V_{GS}=0\text{V}$ , $I_D=1\text{mA}$	75	-	-	V
$\Delta BV_{DSS}/\Delta T_J$	Breakdown Voltage Temperature Coefficient	Reference to $25^{\circ}\text{C}$ , $I_D=1\text{mA}$	-	0.01	-	$\text{V}/^{\circ}\text{C}$
$R_{DS(ON)}$	Static Drain-Source On-Resistance <sup>2</sup>	$V_{GS}=10\text{V}$ , $I_D=60\text{A}$	-	-	5	$\text{m}\Omega$
$V_{GS(th)}$	Gate Threshold Voltage	$V_{DS}=V_{GS}$ , $I_D=250\mu\text{A}$	2	-	4	V
$g_{fs}$	Forward Transconductance	$V_{DS}=10\text{V}$ , $I_D=60\text{A}$	-	57	-	S
$I_{DSS}$	Drain-Source Leakage Current ( $T_J=25^{\circ}\text{C}$ )	$V_{DS}=75\text{V}$ , $V_{GS}=0\text{V}$	-	-	10	$\mu\text{A}$
	Drain-Source Leakage Current ( $T_J=150^{\circ}\text{C}$ )	$V_{DS}=60\text{V}$ , $V_{GS}=0\text{V}$	-	-	250	$\mu\text{A}$
$I_{GSS}$	Gate-Source Leakage	$V_{GS}=\pm 20\text{V}$	-	-	$\pm 100$	nA
$Q_g$	Total Gate Charge <sup>2</sup>	$I_D=80\text{A}$	-	85	135	nC
$Q_{gs}$	Gate-Source Charge	$V_{DS}=40\text{V}$	-	25	-	nC
$Q_{gd}$	Gate-Drain ("Miller") Charge	$V_{GS}=10\text{V}$	-	36	-	nC
$t_{d(on)}$	Turn-on Delay Time <sup>2</sup>	$V_{DS}=40\text{V}$	-	22	-	ns
$t_r$	Rise Time	$I_D=80\text{A}$	-	160	-	ns
$t_{d(off)}$	Turn-off Delay Time	$R_G=3.3\Omega$ , $V_{GS}=10\text{V}$	-	38	-	ns
$t_f$	Fall Time	$R_D=0.5\Omega$	-	165	-	ns
$C_{iss}$	Input Capacitance	$V_{GS}=0\text{V}$	-	4290	6870	pF
$C_{oss}$	Output Capacitance	$V_{DS}=25\text{V}$	-	985	-	pF
$C_{rss}$	Reverse Transfer Capacitance	$f=1.0\text{MHz}$	-	390	-	pF
$R_g$	Gate Resistance	$f=1.0\text{MHz}$	-	1.2	1.8	$\Omega$

## SOURCE-DRAIN DIODE

Symbol	Parameter	Test Conditions	Min.	Typ.	Max.	Units
$V_{SD}$	Forward On Voltage <sup>2</sup>	$I_S=60\text{A}$ , $V_{GS}=0\text{V}$	-	-	1.3	V
$t_{rr}$	Reverse Recovery Time <sup>2</sup>	$I_S=40\text{A}$ , $V_{GS}=0\text{V}$	-	75	-	ns
$Q_{rr}$	Reverse Recovery Charge	$dI/dt=100\text{A}/\mu\text{s}$	-	190	-	nC

### Notes:

1. Pulse width limited by Max. junction temperature.
2. Pulse test
3. Package limitation current is 80A, calculated continuous current based on maximum allowable junction temperature is 169A.
4. Starting  $T_J=25^{\circ}\text{C}$ ,  $L=1\text{mH}$ ,  $I_{AS}=30\text{A}$ .

THIS PRODUCT IS AN ELECTROSTATIC SENSITIVE, PLEASE HANDLE WITH CAUTION.

THIS PRODUCT HAS BEEN QUALIFIED FOR CONSUMER MARKET. APPLICATIONS OR USES AS CRITICAL COMPONENT IN LIFE SUPPORT DEVICE OR SYSTEM ARE NOT AUTHORIZED.

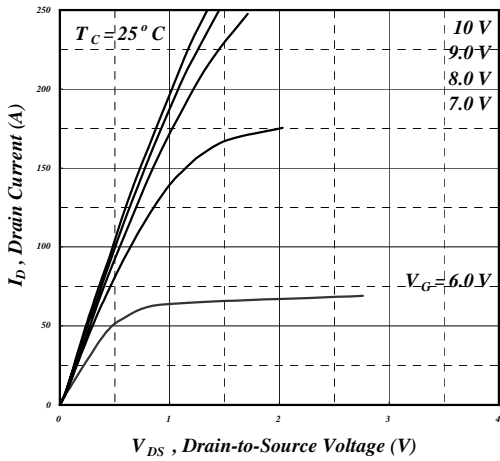

Fig 1. Typical Output Characteristics

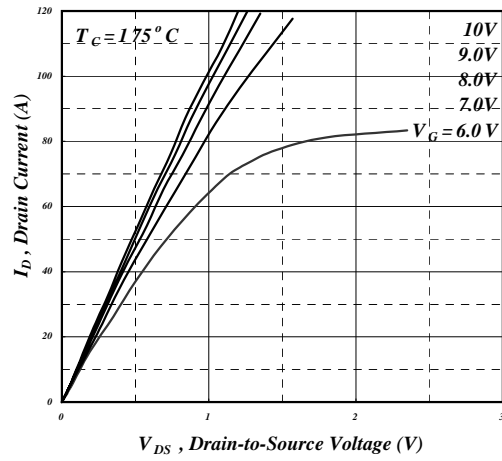

Fig 2. Typical Output Characteristics

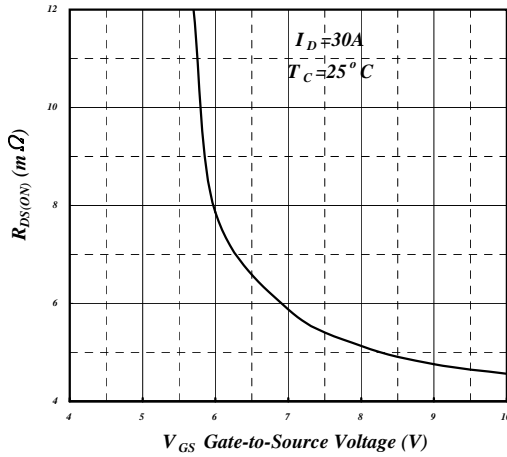

Fig 3. On-Resistance v.s. Gate Voltage

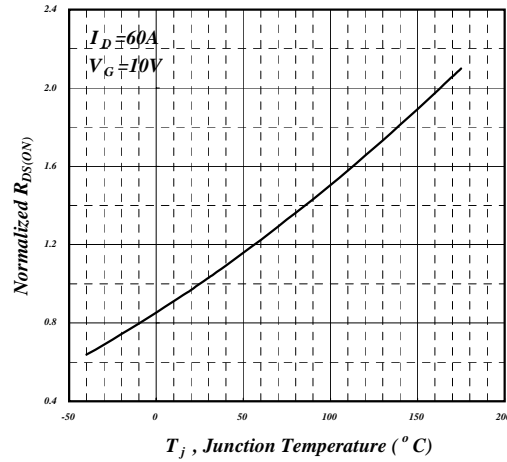

Fig 4. Normalized On-Resistance v.s. Junction Temperature

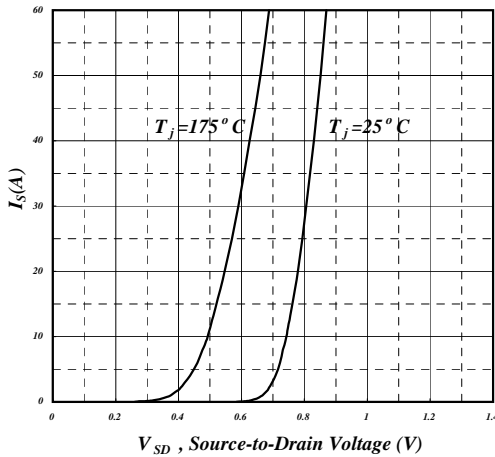

Fig 5. Forward Characteristic of Reverse Diode

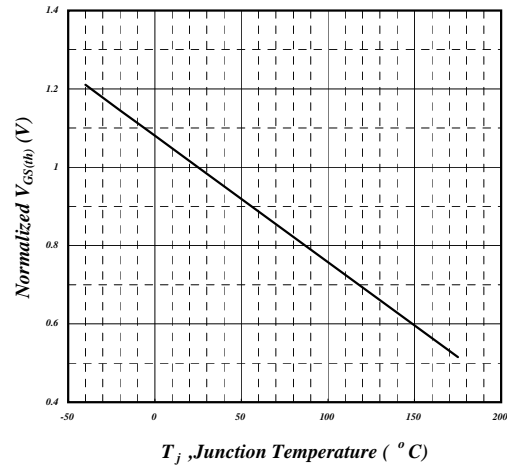

Fig 6. Gate Threshold Voltage v.s. Junction Temperature

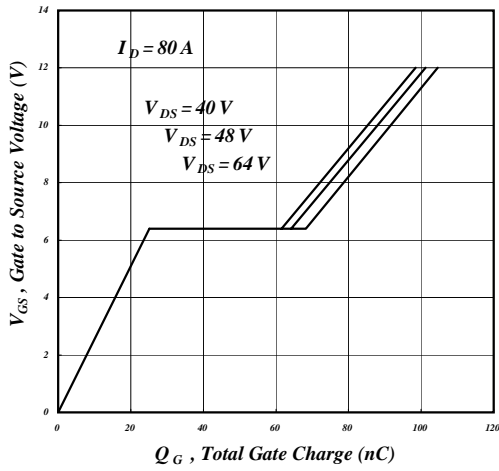

Fig 7. Gate Charge Characteristics

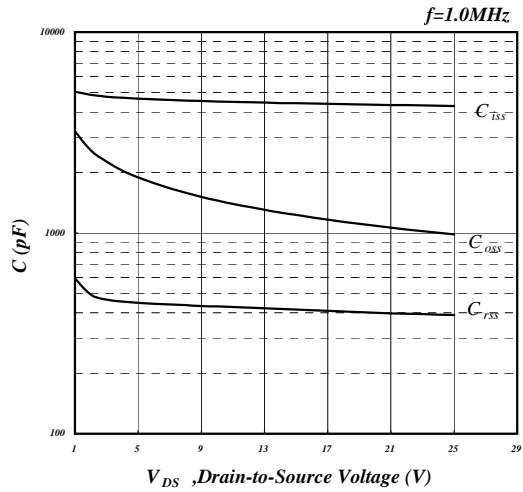

Fig 8. Typical Capacitance Characteristics

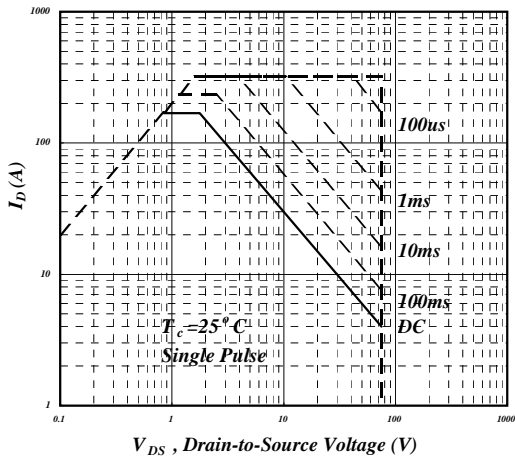

Fig 9. Maximum Safe Operating Area

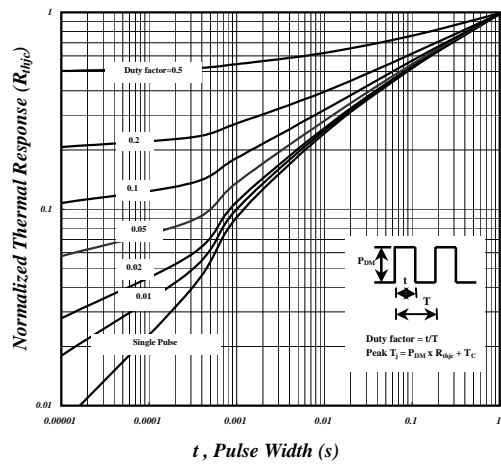

Fig 10. Effective Transient Thermal Impedance

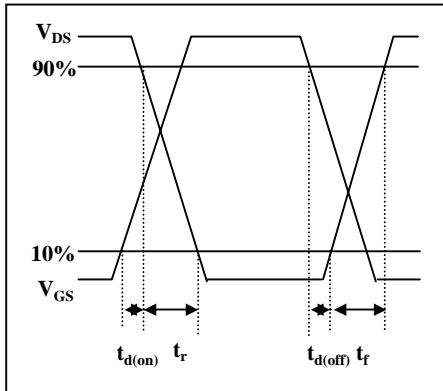

Fig 11. Switching Time Waveform

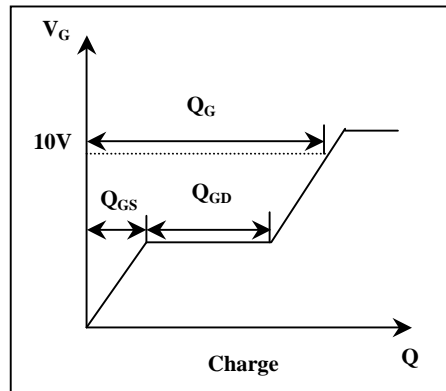
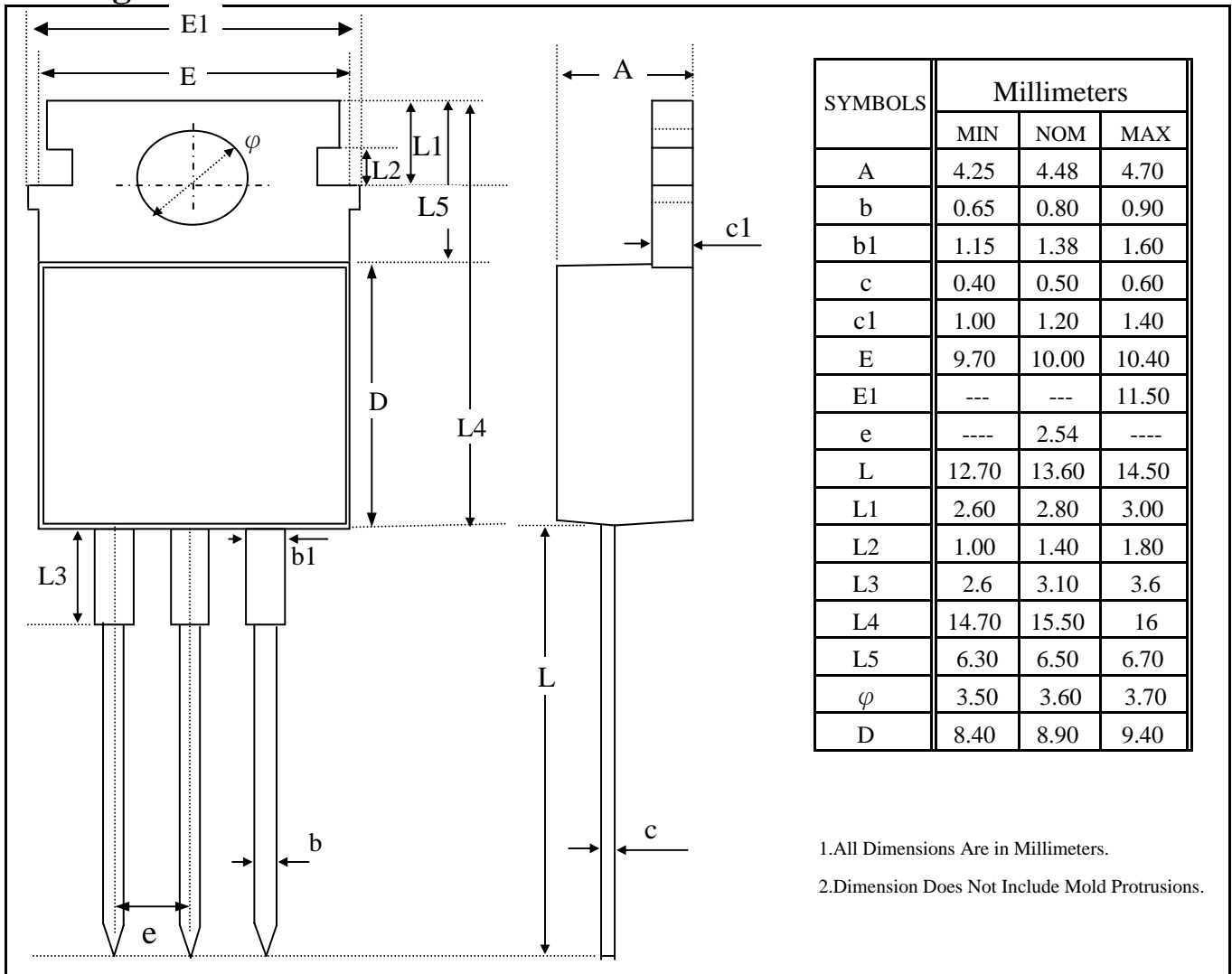
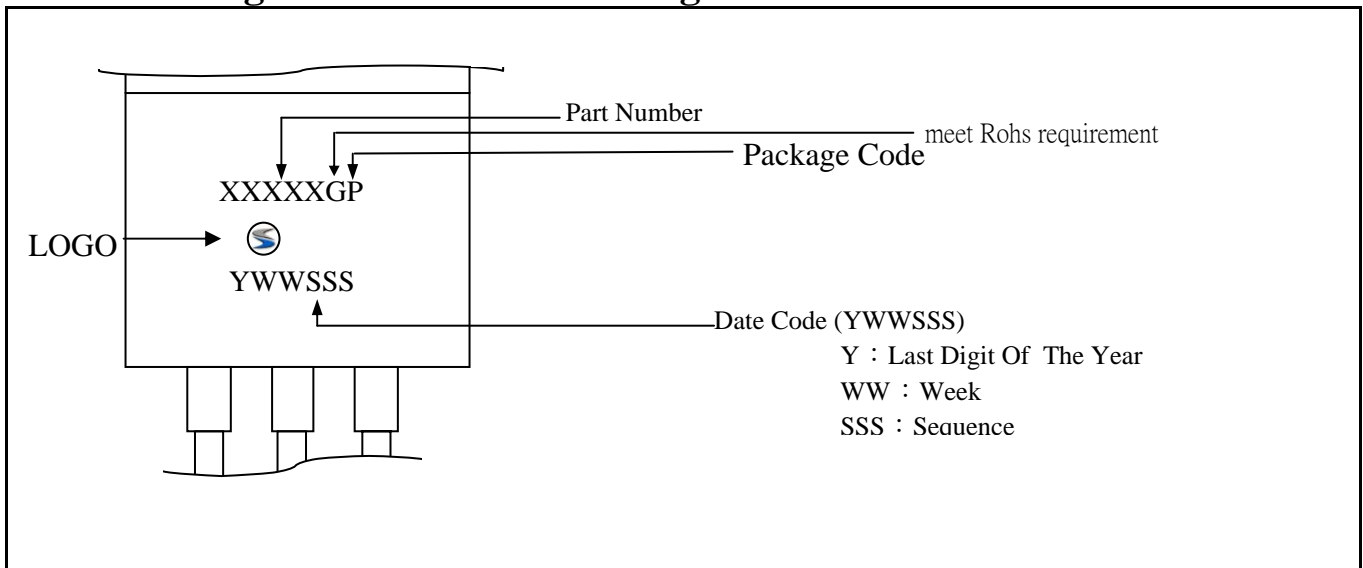

Fig 12. Gate Charge Waveform

**Package Outline : TO-220**



**Part Marking Information & Packing : TO-220**



Information furnished by Silicon Standard Corporation is believed to be accurate and reliable. However, Silicon Standard Corporation makes no guarantee or warranty, expressed or implied, as to the reliability, accuracy, timeliness or completeness of such information and assumes no responsibility for its use, or for infringement of any patent or other intellectual property rights of third parties that may result from its use. Silicon Standard reserves the right to make changes as it deems necessary to any products described herein for any reason, including without limitation enhancement in reliability, functionality or design. No license is granted, whether expressly or by implication, in relation to the use of any products described herein or to the use of any information provided herein, under any patent or other intellectual property rights of Silicon Standard Corporation or any third parties.