



Size:
1.91 x 1.09 x 0.37 in
48,6 x 27,7 x 9,5 mm

Applications

- Off-line distribution for PFC front ends
- Isolated intermediate bus for non-isolated POL
- Telecommunication systems
- Networking
- Servers
- ATE

Features

- 100°C baseplate operation
- 352 V to 11 V Bus Converter
- 300 Watt (450 Watt for 1 ms)
- High density – up to 390 W/in³
- Small footprint – 1.64 and 2.08 in²
- Height above board – 0.37 in (9.5 mm)
- Low weight – 1.10 oz (31.3 g)
- ZVS / ZCS isolated sine amplitude converter
- Typical efficiency 95%
- <1 μs transient response
- >3.5 million hours MTBF
- Isolated output
- No output filtering required
- Lead free wave solder compatible
- Agency approvals

Product Overview

VI BRICK BCM modules use advanced Sine Amplitude Converter™ (SAC™) technology, thermally enhanced packaging technologies, and advanced CIM processes to provide high power density and efficiency, superior transient response, and improved thermal management. These modules can be used to provide an isolated intermediate bus to power non-isolated POL converters and due to the fast response time and low noise of the BCM, capacitance can be reduced or eliminated near the load.

Part Numbering

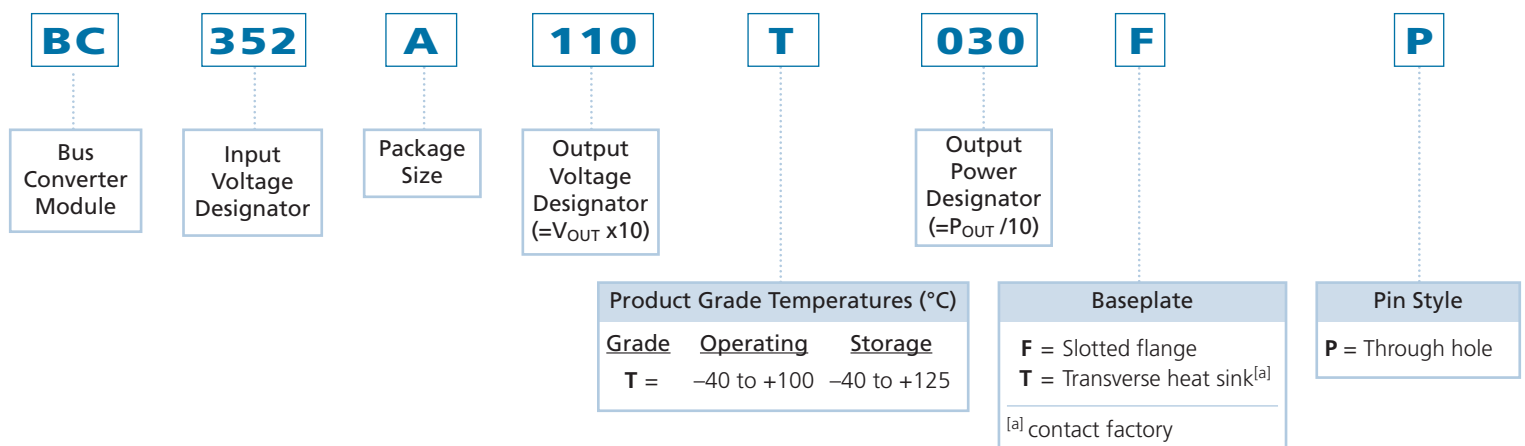

SPECIFICATIONS

Electrical characteristics apply over the full operating range of input voltage, output load (resistive) and baseplate temperature, unless otherwise specified. All temperatures refer to the operating temperature at the center of the baseplate.

Absolute Maximum Ratings

Parameter	Values	Unit	Notes
+In to -In	-1.0 to 400	Vdc	
+In to -In	500	Vdc	For 100 ms
PC to -In	-0.3 to 7.0	Vdc	
+Out to -Out	-0.5 to 16.0	Vdc	
Isolation voltage	4,242	Vdc	Input to output
Output current	30.4	A	Continuous
Peak output current	41.0	A	For 1 ms
Output power	300	W	Continuous
Peak output power	450	W	For 1 ms
Operating temperature	-40 to 100	°C	T-Grade; baseplate
Storage temperature	-40 to 125	°C	T-Grade

Note: Stresses in excess of the maximum ratings can cause permanent damage to the device. Operation of the device is not implied at these or any other conditions in excess of those given in the specification. Exposure to absolute maximum ratings can adversely affect device reliability.

Input Specifications *(Conditions are at 352 Vin, full load, and 25°C ambient unless otherwise specified)*

Parameter	Min	Typ	Max	Unit	Notes
Input voltage range	330	352	365	Vdc	
Input dV/dt			1	V/μs	
Input undervoltage turn-on			325	Vdc	
Input undervoltage turn-off	275		315	Vdc	
Input overvoltage turn-on	366			Vdc	
Input overvoltage turn-off			399	Vdc	
Input quiescent current		1.2		mA	PC low
Inrush current overshoot		0.2		A	Using test circuit in Figure 15; See Figure 1
Input current			0.9	Adc	
Input reflected ripple current		400		mA p-p	Using test circuit in Figure 15; See Figure 4
No load power dissipation		4.3	7.0	W	
Internal input capacitance		0.2		μF	
Internal input inductance		5		nH	
Recommended external input capacitance		2		μF	200 nH maximum source inductance; See Figure 15

INPUT WAVEFORMS

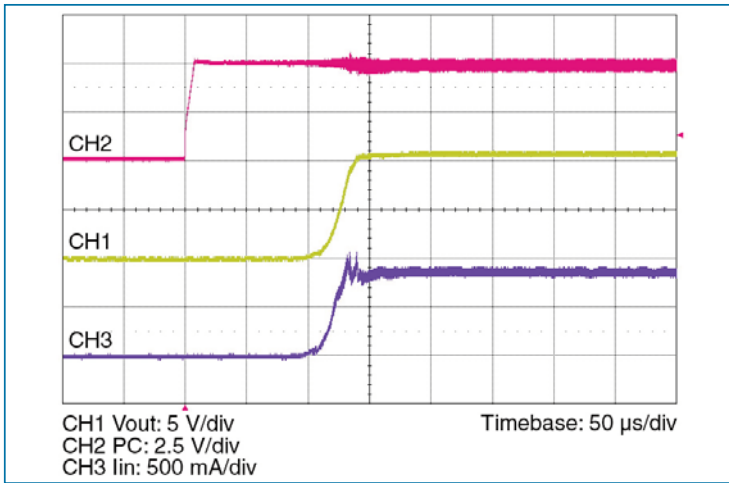

Figure 1 — Inrush transient current at full load and 352 Vin with PC enabled

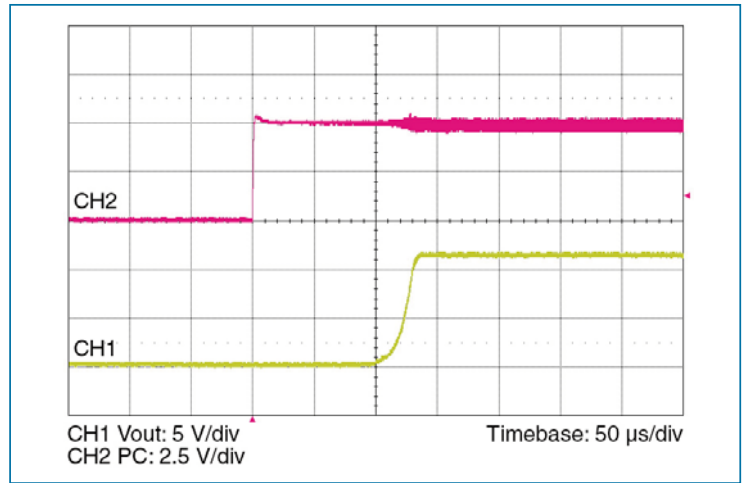

Figure 2 — Output voltage turn-on waveform with PC enabled at full load and 352 Vin

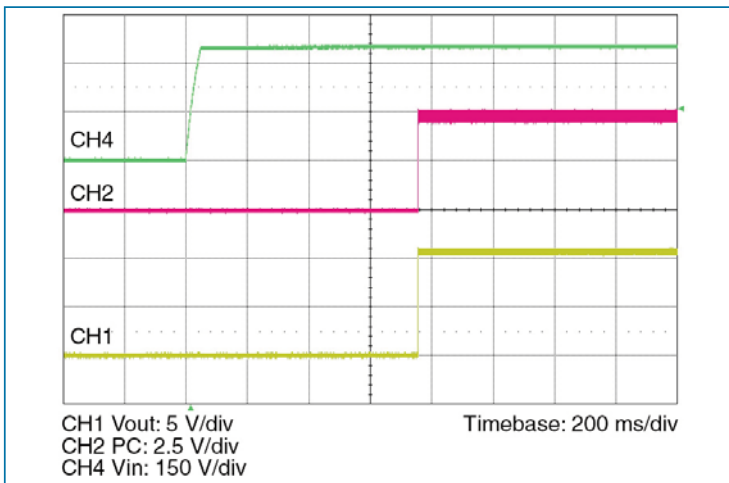

Figure 3 — Output voltage turn-on waveform with input turn-on at full load and 352 Vin

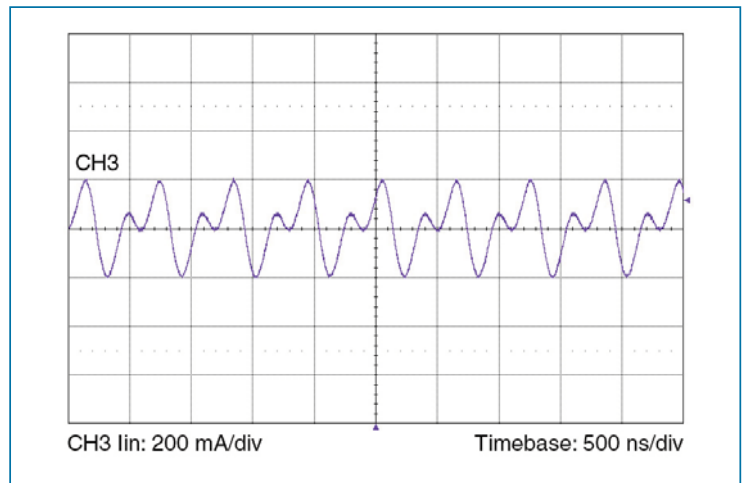

Figure 4 — Input reflected ripple current at full load and 352 Vin

Output Specifications (Conditions are at 352 V _{in} , full load, and 25°C ambient unless otherwise specified)					
Parameter	Min	Typ	Max	Unit	Note
Output voltage	10.3		11.4	Vdc	No load
	9.91		11.0	Vdc	Full load
Output power	0		300	W	330 - 365 V _{IN}
Rated DC current	0		30.4	Adc	P _{OUT} ≤ 300 W
Peak repetitive power			450	W	Max pulse width 1ms, max duty cycle 10%, baseline power 50%
Current share accuracy		5	10	%	See Parallel Operation on Page 8
Efficiency					
Half load	93.5	95.8		%	See Figure 5
Full load	94.3	95.5		%	See Figure 5
Internal output inductance		1.1		nH	
Internal output capacitance		31		μF	Effective value
Load capacitance			1,200	μF	
Output overvoltage setpoint	11.4			Vdc	
Output ripple voltage					
No external bypass		200	400	mVp-p	See Figures 7 and 9
10 μF bypass capacitor		13		mVp-p	See Figure 8
Short circuit protection set point	38.0			Adc	Module will shut down
Average short circuit current		0.18		A	
Effective switching frequency	3.3	3.4	3.5	MHz	Fixed, 1.7 MHz per phase
Line regulation					
K	0.0309	1/32	0.0316		V _{OUT} = K•V _{IN} at no load
Load regulation					
R _{OUT}		12.2	15.0	mΩ	
Transient response					
Voltage overshoot		115		mV	100% load step; See Figures 10 and 11
Response time		200		ns	See Figures 10 and 11
Recovery time		1		μs	See Figures 10 and 11
Output overshoot					
Input turn-on		0		mV	No output filter; See Figure 3
PC enable		0		mV	No output filter; See Figure 2
Output turn-on delay					
From application of power		750		ms	No output filter; See Figure 3
From release of PC pin		160		ms	No output filter

OUTPUT WAVEFORMS

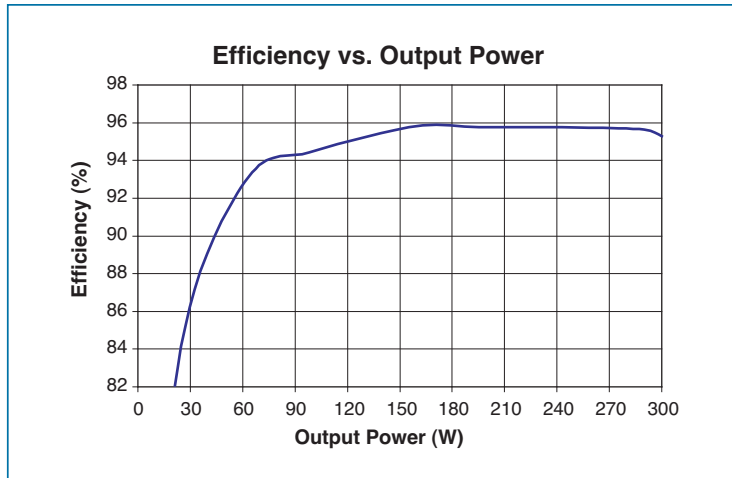

Figure 5 — Efficiency vs. output power

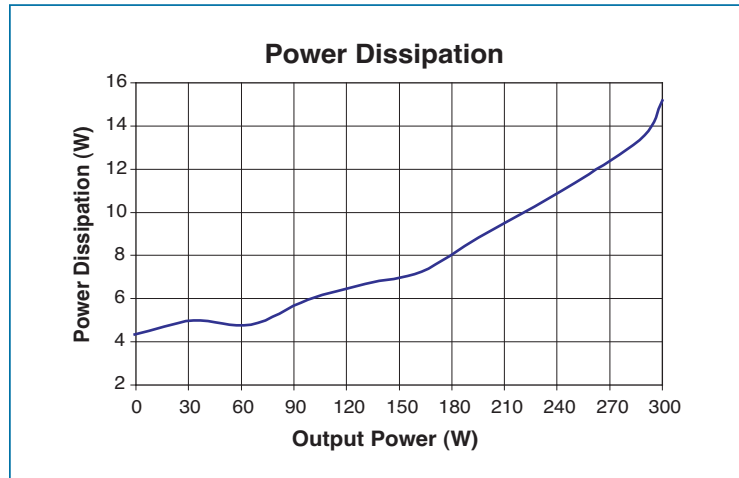

Figure 6 — Power dissipation as a function of output power

SPECIFICATIONS (CONT.)

OUTPUT WAVEFORMS

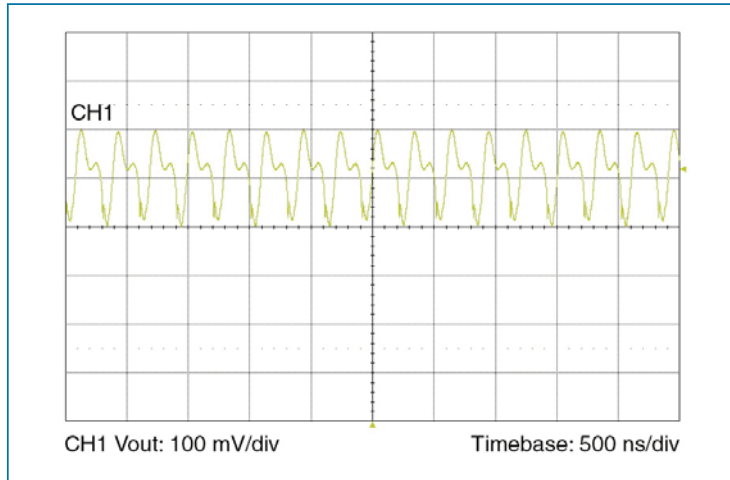

Figure 7 — Output voltage ripple at full load and 352 Vin without any external bypass capacitor.

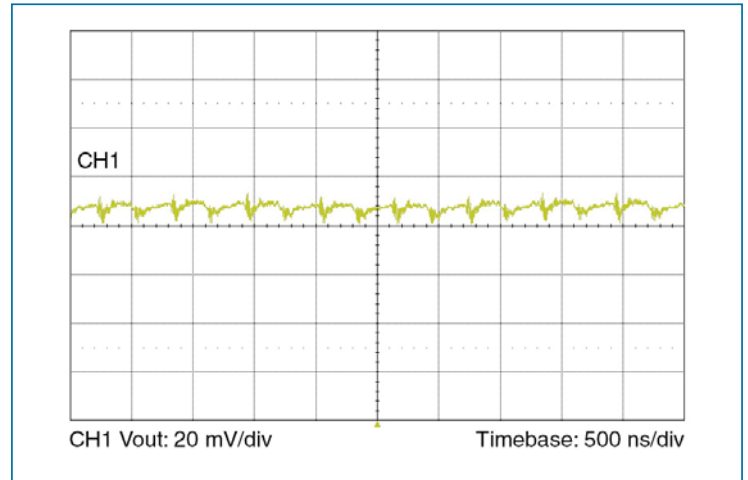

Figure 8 — Output voltage ripple at full load and 352 Vin with 10 μF ceramic external bypass capacitor and 20 nH of distribution inductance.

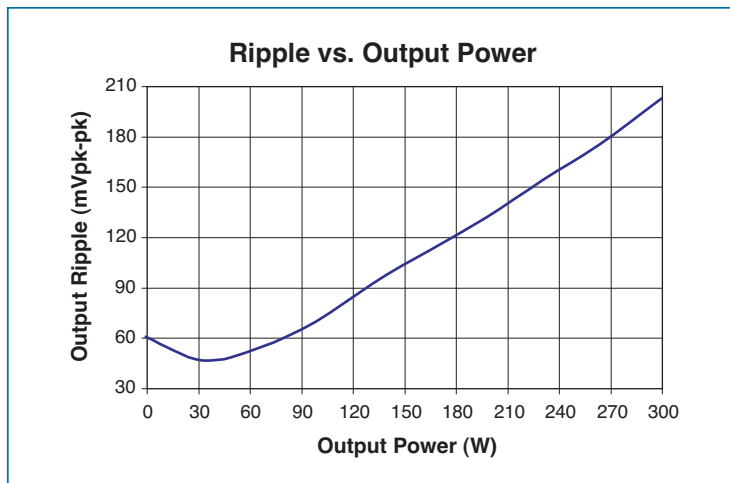

Figure 9 — Output voltage ripple vs. output power at 352 Vin without any external bypass capacitor.

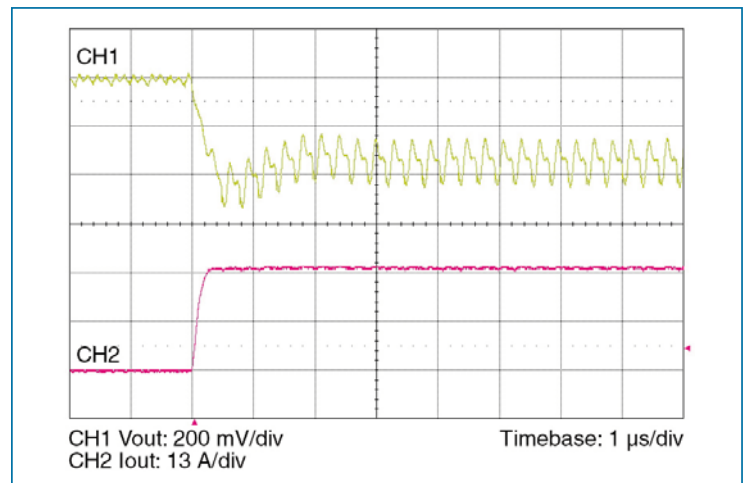

Figure 10 — 0-27.3 A load step with 2 μF input capacitor and no output capacitor.

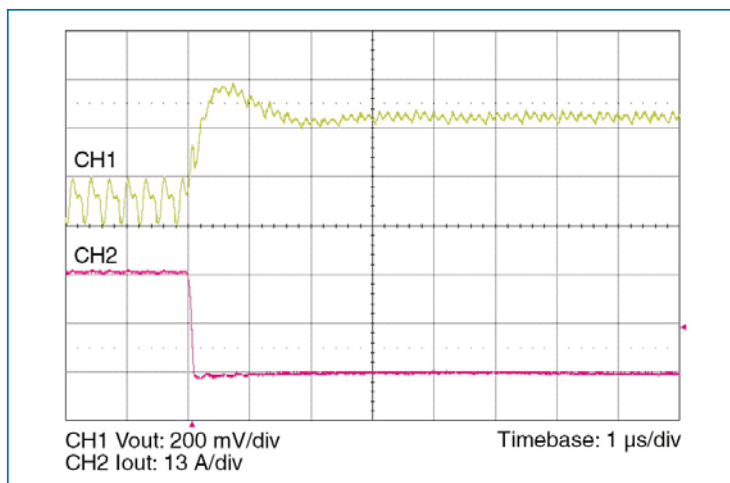

Figure 11 — 27.3-0 A load step with 2 μF input capacitor and no output capacitor.

SPECIFICATIONS (CONT.)

General Specifications

Parameter	Min	Typ	Max	Unit	Notes
MTBF					
MIL-HDBK-217F		3.5		Mhrs	25°C, GB
Isolation specifications					
Voltage	4,242			Vdc	Input to output
Capacitance		500		pF	Input to output
Resistance	10			MΩ	Input to output
		cTÜVus			UL/CSA 60950-1, EN 60950-1
Agency approvals		CE Mark			Low voltage directive
		RoHS			
Mechanical					
Weight		1.10/31,3		oz/g	See Mechanical Drawings, Figure 18, 19
Dimensions					
Length		1.91/48,6		in/mm	Baseplate model
Width		1.09/27,7		in/mm	Baseplate model
Height		0.37/9,5		in/mm	Baseplate model
Thermal					
Over temperature shutdown	125	130	135	°C	Junction temperature
Thermal capacity		23.8		Ws/°C	
Baseplate to ambient		7.7		°C/W	
Baseplate to ambient; 1000 LFM		2.9		°C/W	
Baseplate to sink; flat greased surface		0.40		°C/W	
Baseplate to sink; thermal pad		0.36		°C/W	

Auxiliary Pins

Parameter	Min	Typ	Max	Unit	Notes
Primary control (PC)					
DC voltage	4.8	5.0	5.2	Vdc	
Module disable voltage	2.4	2.5		Vdc	
Module enable voltage		2.5	2.6	Vdc	
Current limit	2.4	2.5	2.9	mA	Source only
Enable delay time		160		ms	
Disable delay time		20		μs	See Figure 12, time from PC low to output low

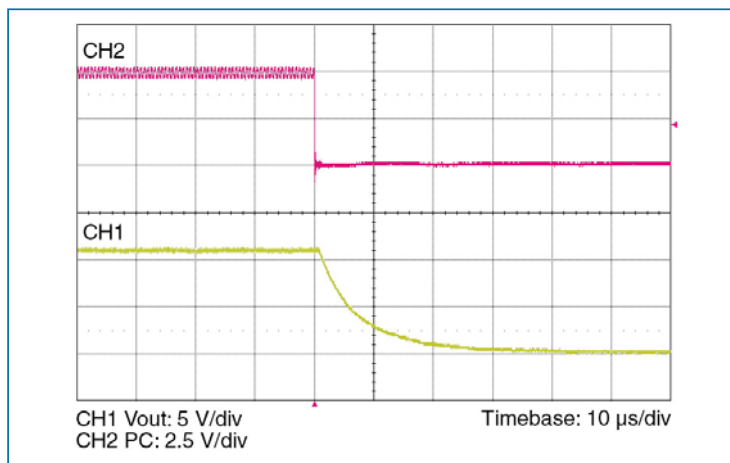

Figure 12 — V_{OUT} at full load vs. PC disable

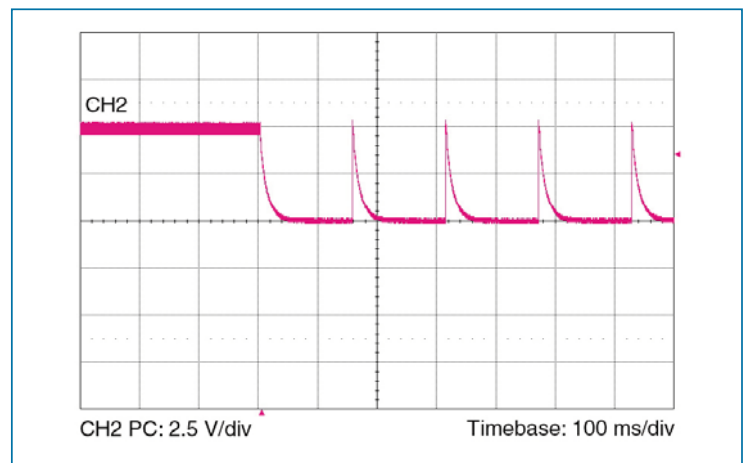

Figure 13 — PC signal during fault

+In / -In – DC Voltage Input Ports

The VI BRICK (BCM) input voltage range should not be exceeded. An internal under / over voltage lockout function prevents operation outside of the normal operating input range. The BCM turns on within an input voltage window bounded by the “Input undervoltage turn-on” and “Input overvoltage turn-off” levels, as specified. The BCM may be protected against accidental application of a reverse input voltage by the addition of a rectifier in series with the positive input, or a reverse rectifier in shunt with the positive input located on the load side of the input fuse.

The connection of the BCM to its power source should be implemented with minimal distribution inductance. If the interconnect inductance exceeds 100 nH, the input should be bypassed with a RC damper to retain low source impedance and stable operation. With an interconnect inductance of 200 nH, the RC damper may be 2 μ F in series with 0.3 Ω . A single electrolytic or equivalent low-Q capacitor may be used in place of the series RC bypass.

PC – Primary Control

The Primary Control port is a multifunction node that provides the following functions:

Enable / Disable – If the PC port is left floating, the BCM output is enabled. Once this port is pulled lower than 2.4 Vdc with respect to –In, the output is disabled. This action can be realized by employing a relay, opto-coupler, or open collector transistor. Refer to Figures 1-3, 12 and 13 for the typical enable / disable characteristics. This port should not be toggled at a rate higher than 1 Hz. The PC port should also not be driven by or pulled up to an external voltage source.

Primary Auxiliary Supply – The PC port can source up to 2.4 mA at 5.0 Vdc. The PC port should never be used to sink current.

Alarm – The BCM contains circuitry that monitors output overload, input overvoltage or undervoltage, and internal junction temperatures. In response to an abnormal condition in any of the monitored parameters, the PC port will toggle. Refer to Figure 13 for PC alarm characteristics.

TM and RSV – Reserved for factory use.

+Out / -Out – DC Voltage Output Ports

Two sets of contacts are provided for the +Out port. They must be connected in parallel with low interconnect resistance. Similarly, two sets of contacts are provided for the –Out port. They must be connected in parallel with low interconnect resistance. Within the specified operating range, the average output voltage is defined by the Level 1 DC behavioral model of Figure 16. The current source capability of the BCM is rated in the specifications section of this document.

The low output impedance of the BCM reduces or eliminates the need for limited life aluminum electrolytic or tantalum capacitors at the input of POL converters.

Total load capacitance at the output of the BCM should not exceed the specified maximum. Owing to the wide bandwidth and low output impedance of the BCM, low frequency bypass capacitance and significant energy storage may be more densely and efficiently provided by adding capacitance at the input of the BCM.

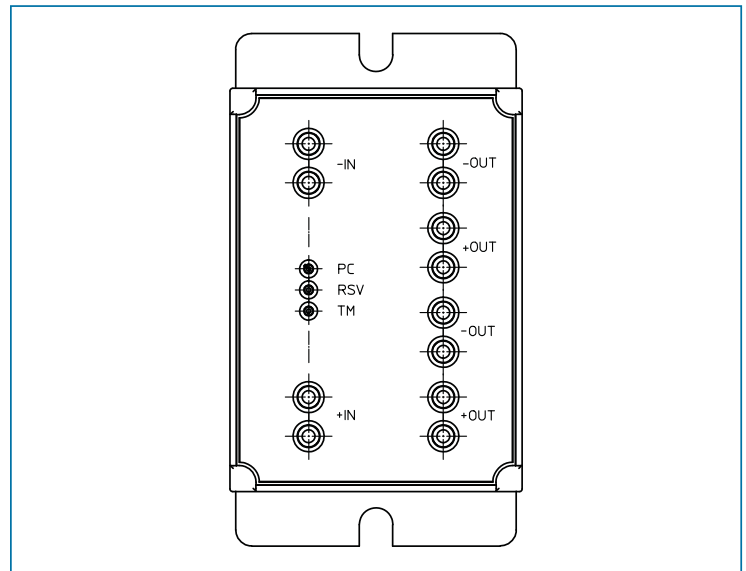

Figure 14 — VI BRICK BCM pin configuration (viewed from pin side)

Parallel Operation

The BCM will inherently current share when operated in an array. Arrays may be used for higher power or redundancy in an application.

Current sharing accuracy is maximized when the source and load impedance presented to each BCM within an array are equal. The recommended method to achieve matched impedances is to dedicate common copper planes within the PCB to deliver and return the current to the array, rather than rely upon traces of varying lengths. In typical applications the current being delivered to the load is larger than that sourced from the input, allowing traces to be utilized on the input side if necessary. The use of dedicated power planes is, however, preferable.

The BCM power train and control architecture allow bi-directional power transfer, including reverse power processing from the BCM output to its input. Reverse power transfer is enabled if the BCM input is within its operating range and the BCM is otherwise enabled. The BCM's ability to process power in reverse improves the BCM transient response to an output load dump.

Input Impedance Recommendations

To take full advantage of the BCM capabilities, the impedance presented to its input terminals must be low from DC to approximately 5 MHz. The source should exhibit low inductance (less than 100 nH) and should have a critically damped response. If the interconnect inductance exceeds 100 nH, the BCM input pins should be bypassed with an RC damper (e.g., 2 μ F in series with 0.3 Ω) to retain low source impedance and stable operations. Given the wide bandwidth of the BCM, the source response is generally the limiting factor in the overall system response.

Anomalies in the response of the source will appear at the output of the BCM multiplied by its K factor. The DC resistance of the source should be kept as low as possible to minimize voltage deviations. This is especially important if the BCM is operated near low or high line as the over/under voltage detection circuitry could be activated.

Input Fuse Recommendations

VI BRICKs are not internally fused in order to provide flexibility in configuring power systems. However, input line fusing of VI BRICKs must always be incorporated within the power system. A fast acting fuse should be placed in series with the +In port. For agency approvals and fusing conditions, click on the link below:

http://www.vicorpower.com/technical_library/technical_documentation/quality_and_certification/safety_approvals/

Application Notes

For BCM and VI BRICK application notes on soldering, board layout, and system design please click on the link below:

http://www.vicorpower.com/technical_library/application_information/

Applications Assistance

Please contact Vicor Applications Engineering for assistance, 1-800-927-9474, or email at apps@vicorpower.com.

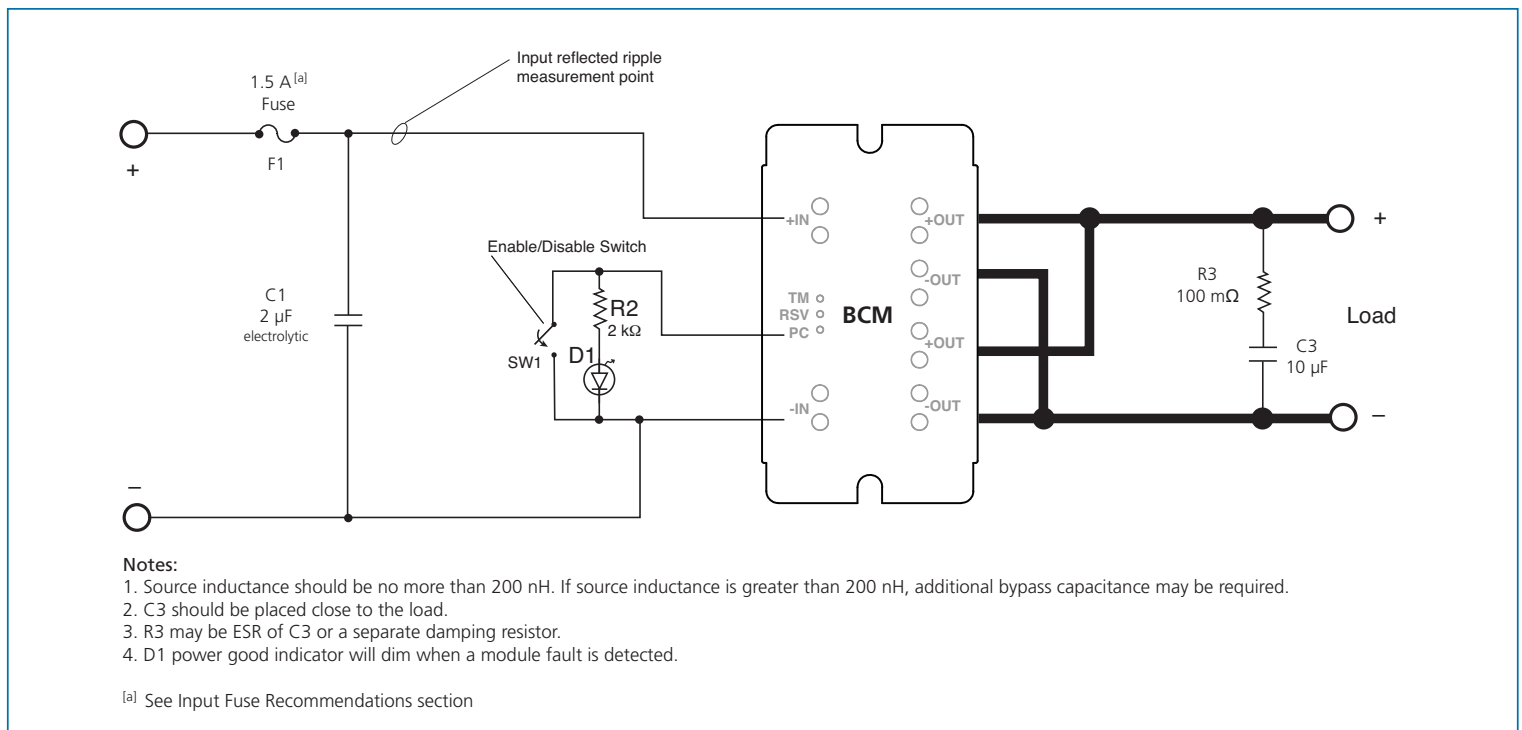

Figure 15 — VI BRICK BCM test circuit

VI BRICK Bus Converter Level 1 DC Behavioral Model for 352 V to 11 V, 300 W

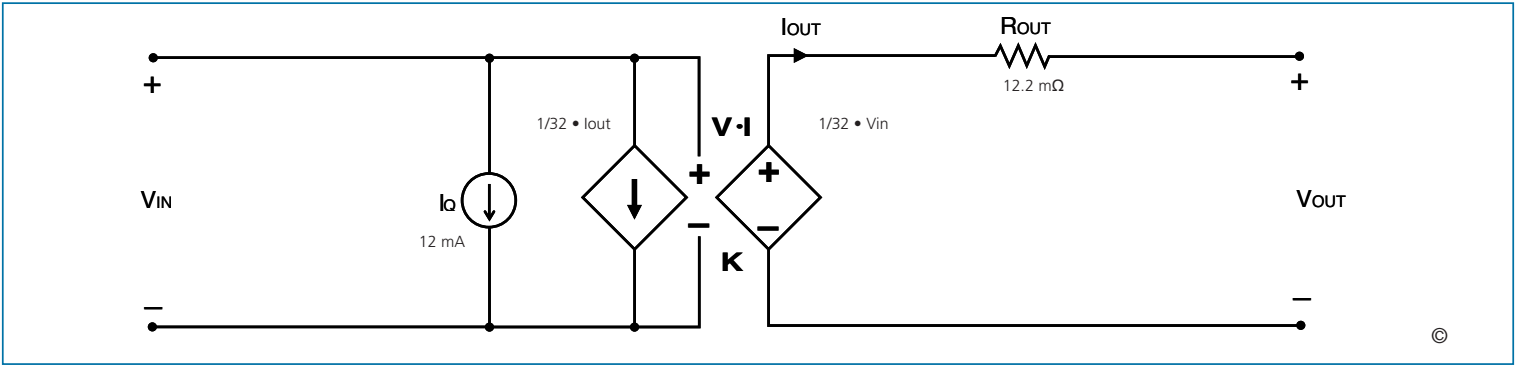

Figure 16 — This model characterizes the DC operation of the VI BRICK bus converter, including the converter transfer function and its losses. The model enables estimates or simulations of output voltage as a function of input voltage and output load, as well as total converter power dissipation or heat generation.

VI BRICK Bus Converter Level 2 Transient Behavioral Model for 352 V to 11 V, 300 W

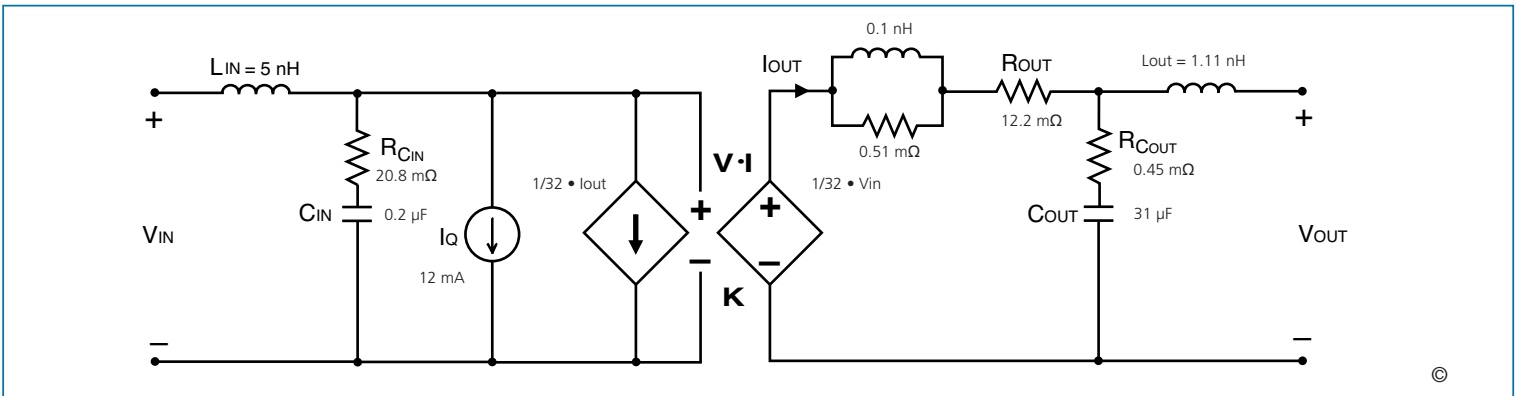

Figure 17 — This model characterizes the AC operation of the VI BRICK bus converter including response to output load or input voltage transients or steady state modulations. The model enables estimates or simulations of input and output voltages under transient conditions, including response to a stepped load with or without external filtering elements.

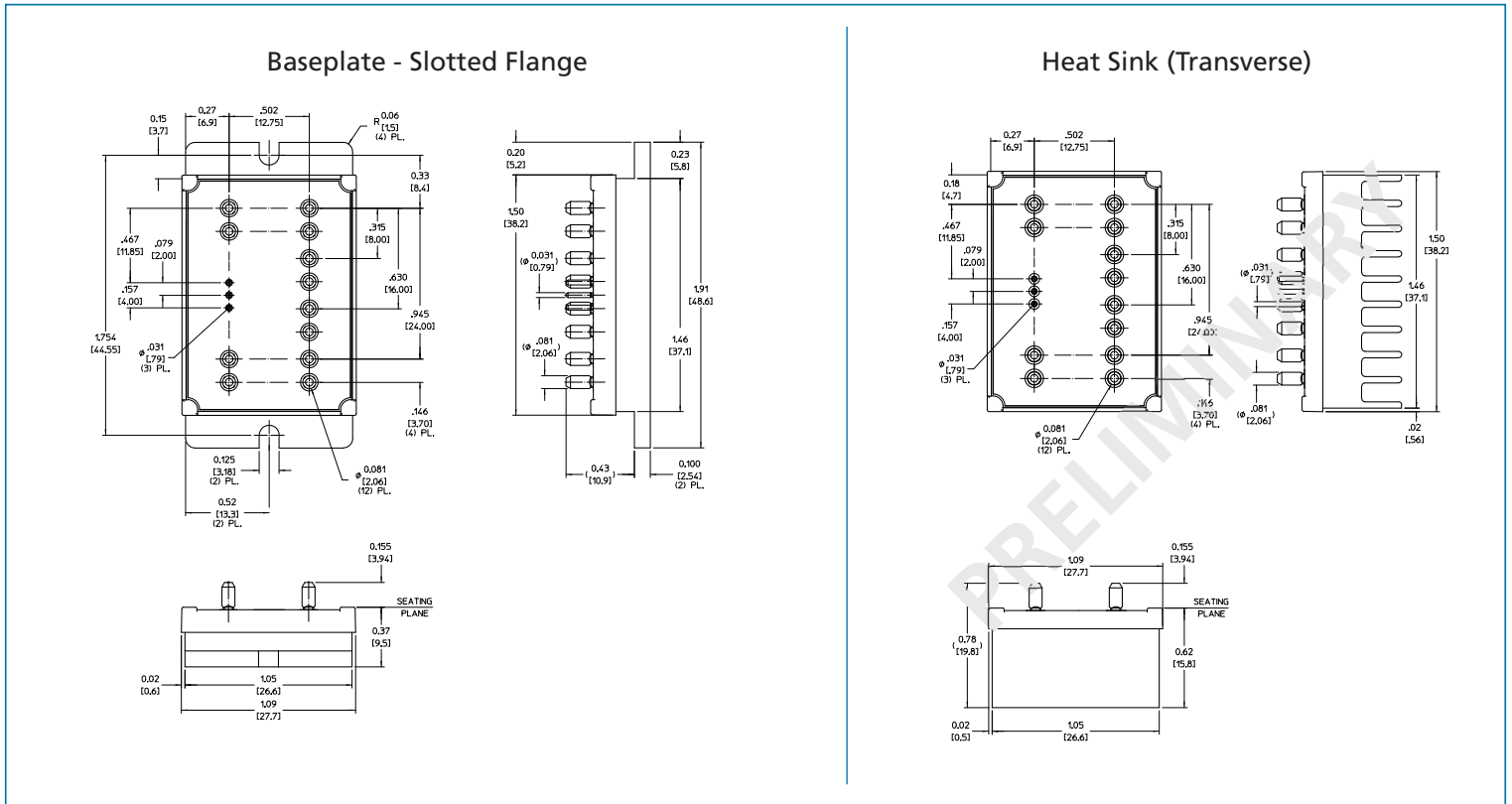

Figure 18 — Module outline

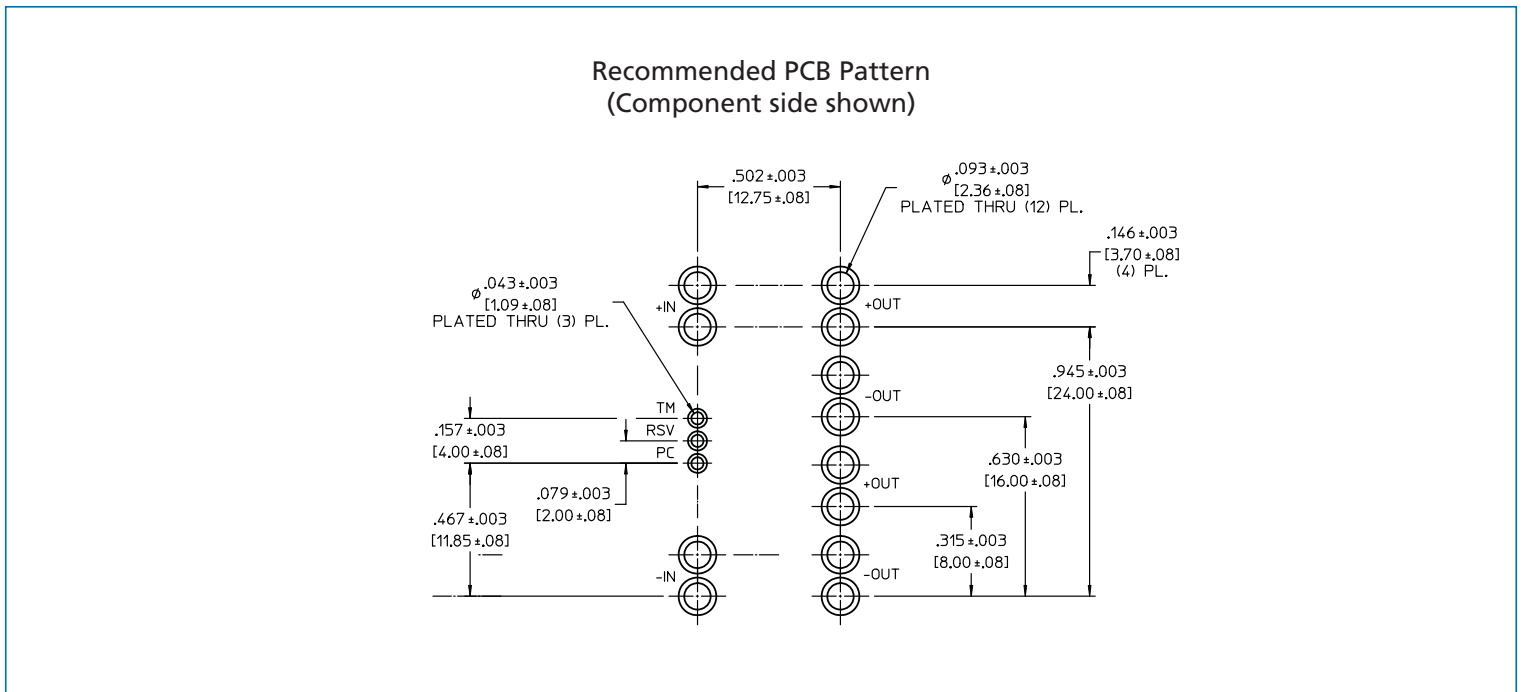

Figure 19 — PCB mounting specifications

Warranty

Vicor products are guaranteed for two years from date of shipment against defects in material or workmanship when in normal use and service. This warranty does not extend to products subjected to misuse, accident, or improper application or maintenance. Vicor shall not be liable for collateral or consequential damage. This warranty is extended to the original purchaser only.

EXCEPT FOR THE FOREGOING EXPRESS WARRANTY, VICOR MAKES NO WARRANTY, EXPRESS OR IMPLIED, INCLUDING, BUT NOT LIMITED TO, THE WARRANTY OF MERCHANTABILITY OR FITNESS FOR A PARTICULAR PURPOSE.

Vicor will repair or replace defective products in accordance with its own best judgement. For service under this warranty, the buyer must contact Vicor to obtain a Return Material Authorization (RMA) number and shipping instructions. Products returned without prior authorization will be returned to the buyer. The buyer will pay all charges incurred in returning the product to the factory. Vicor will pay all reshipment charges if the product was defective within the terms of this warranty.

Information published by Vicor has been carefully checked and is believed to be accurate; however, no responsibility is assumed for inaccuracies. Vicor reserves the right to make changes to any products without further notice to improve reliability, function, or design. Vicor does not assume any liability arising out of the application or use of any product or circuit; neither does it convey any license under its patent rights nor the rights of others. Vicor general policy does not recommend the use of its components in life support applications wherein a failure or malfunction may directly threaten life or injury. Per Vicor Terms and Conditions of Sale, the user of Vicor components in life support applications assumes all risks of such use and indemnifies Vicor against all damages.

Vicor's comprehensive line of power solutions includes high density AC-DC and DC-DC modules and accessory components, fully configurable AC-DC and DC-DC power supplies, and complete custom power systems.

Information furnished by Vicor is believed to be accurate and reliable. However, no responsibility is assumed by Vicor for its use. Vicor components are not designed to be used in applications, such as life support systems, wherein a failure or malfunction could result in injury or death. All sales are subject to Vicor's Terms and Conditions of Sale, which are available upon request.

Specifications are subject to change without notice.

Intellectual Property Notice

Vicor and its subsidiaries own Intellectual Property (including issued U.S. and Foreign Patents and pending patent applications) relating to the products described in this data sheet. Interested parties should contact Vicor's Intellectual Property Department.

The products described on this data sheet are protected by the following U.S. Patents Numbers:
5,945,130; 6,403,009; 6,710,257; 6,911,848; 6,930,893; 6,934,166; 6,940,013; 6,969,909; 7,038,917;
7,166,898; 7,187,263; 7,361,844; D496,906; D505,114; D506,438; D509,472; and for use under 6,975,098
and 6,984,965

Vicor Corporation
25 Frontage Road
Andover, MA, USA 01810
Tel: 800-735-6200
Fax: 978-475-6715

email

Customer Service: custserv@vicorpower.com
Technical Support: apps@vicorpower.com