

GaAs MMIC SP4T NON-REFLECTIVE SWITCH, DC - 7.0 GHz

Typical Applications

This switch is ideal for DC - 7.0 GHz applications:

- RF Telecom/Datacom
- UNII & HiperLAN
- Wireless Local Loop

Features

- Broadband Performance: DC to 7 GHz
- Single Positive Supply: Vdd = +5V
- Integrated 2:4 TTL Decoder
- Ceramic SMT Package

Functional Diagram

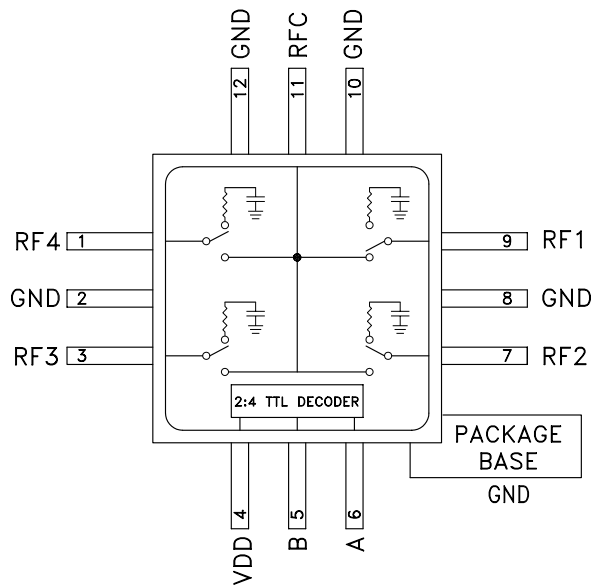

General Description

The HMC222C12 is a broadband non-reflective SP4T switch in a ceramic surface mount package. This SP4T switch covers RF telecom/datacom bands from DC - 7 GHz. The switch offers a single positive bias and true TTL/CMOS compatibility. A 2:4 decoder is integrated on the switch requiring only 2 control lines and a +5V bias to select each path. An input IP3 of +43 dBm helps maintain the best possible dynamic range in receiver & test instrument applications. The integrated 2:4 TTL/CMOS decoder replaces 8 control lines normal required by GaAs SP4T switches.

Electrical Specifications, $T_A = +25^\circ C$, For TTL Control and Vdd = +5V

Parameter	Frequency	Min.	Typ.	Max.	Units
Insertion Loss	DC - 2.0 GHz		1.8	2.2	dB
	DC - 7.0 GHz		2.0	2.7	dB
Isolation	DC - 1.0 GHz	42	52		dB
	DC - 2.0 GHz	37	43		dB
	DC - 7.0 GHz	25	30		dB
Return Loss	"On State"	DC - 2.0 GHz	12	15	dB
		DC - 7.0 GHz	7	10	dB
Return Loss (RF1-4)	"Off State"	0.7 - 7.0 GHz	6.5	10	dB
		2.0 - 7.0 GHz	8	14	dB
Input Power for 1 dB Compression	0.5 - 7.0 GHz	17	20		dBm
Input Third Order Intercept (Two Tone Input Power =+7 dBm Each Tone)	0.5 - 7.0 GHz		43		dBm
Switching Characteristics	0.5 - 7.0 GHz				
tRISE, tFALL (10/90% RF)			35		nS
tON, tOFF (50% CTL to 10/90% RF)			150		nS

GaAs MMIC SP4T NON-REFLECTIVE SWITCH, DC - 7.0 GHz

Insertion Loss vs. Temperature

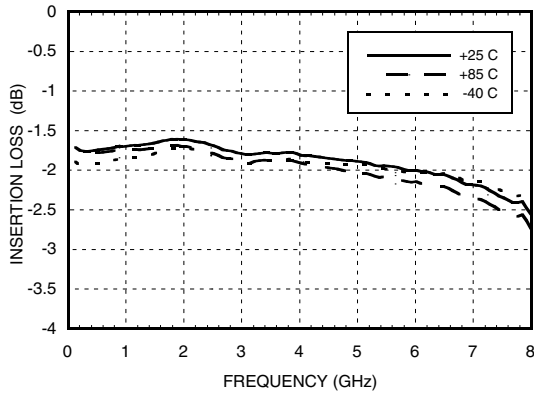

Isolation

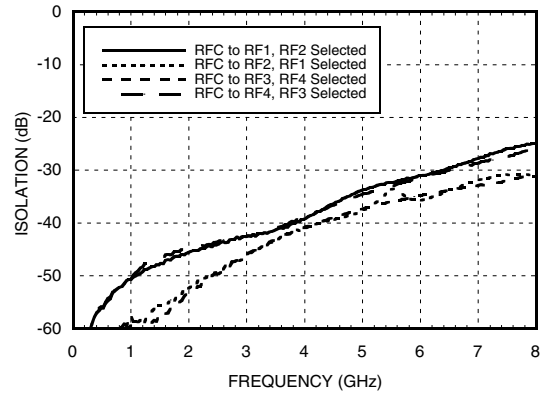

Return Loss

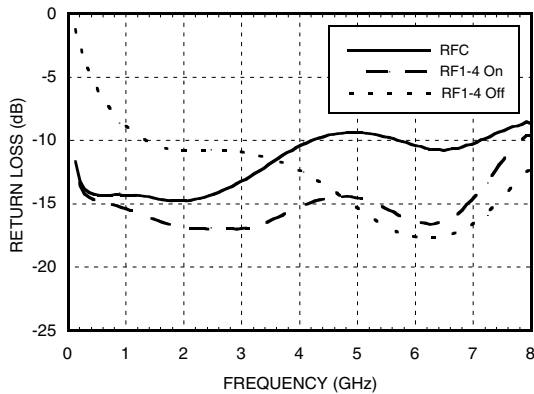

0.1 and 1 dB Input Compression Point

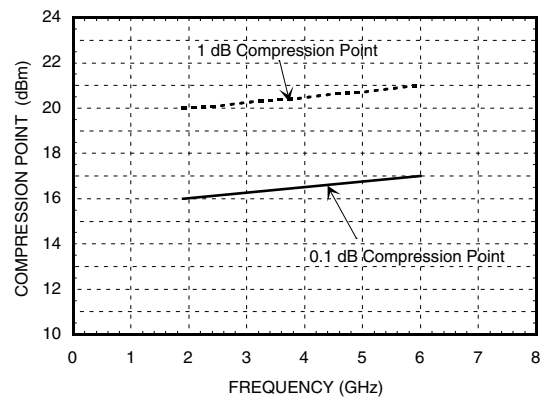

GaAs MMIC SP4T NON-REFLECTIVE SWITCH, DC - 7.0 GHz

Bias Voltage & Current

Vdd Range = +5.0 Vdc ± 10%		
Vdd (Vdc)	Idd (Typ.) (mA)	Idd (Max.) (mA)
+5.0	3.0	5.0

TTL/CMOS Control Voltages

State	Bias Condition
Low	0 to +0.8Vdc @ 5uA Typ.
High	+2.0 to +5.0 Vdc @ 50uA Typ.

Truth Table

Control Input		Signal Path State
A	B	RFCOM to:
Low	Low	RF1
High	Low	RF2
Low	High	RF3
High	High	RF4

GaAs MMIC SP4T NON-REFLECTIVE SWITCH, DC - 7.0 GHz

Absolute Maximum Ratings

Bias Voltage Range (Port Vdd)	+7.0 Vdc
Control Voltage Range (A & B)	-0.5V to Vdd +1Vdc
Storage Temperature	-65 to +150 deg C
Operating Temperature	-40 to +85 deg C
Maximum Input Power Vdd = +5 Vdc	+16 dBm (0.05 - 0.5 GHz) +22 dBm (0.5 - 6.0 GHz)

NOTE:

DC blocking capacitors are required at ports RFC and RF1, 2, 3, 4.

Outline Drawing

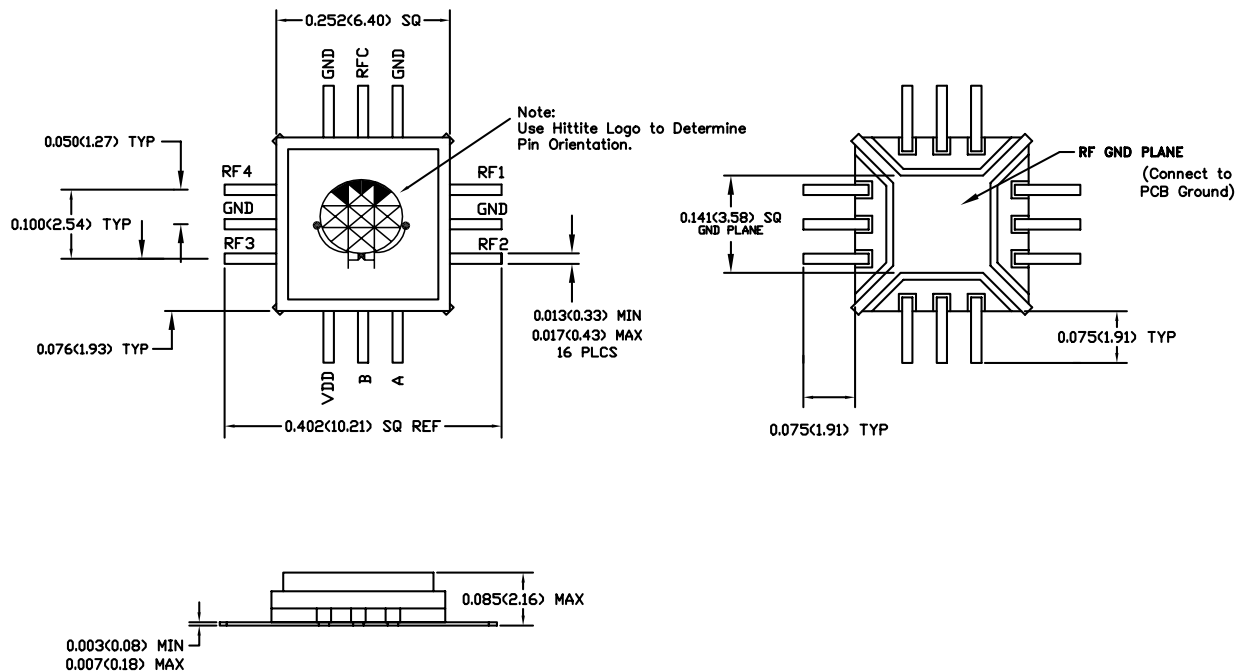

- MATERIAL:
 - PACKAGE BODY & COVER: WHITE ALUMINA (92%)
 - LEADS: KOVAR (TM) OR ASTM F-15 (ALLOY 42) EQUIVALENT
- PLATING(LEADS): ELECTROLYTIC GOLD 25 MICROINCHES. MINIMUM, OVER ELECTROLYTIC NICKEL 100 TO 250 MICROINCHES
- DIMENSIONS ARE IN INCHES (MILLIMETERS). UNLESS OTHERWISE SPECIFIED ALL TOL. ARE ±0.005.
- ALL UNLABELED LEADS ARE GROUND.

GaAs MMIC SP4T NON-REFLECTIVE SWITCH, DC - 7.0 GHz

Eval Board Layout (Top View)

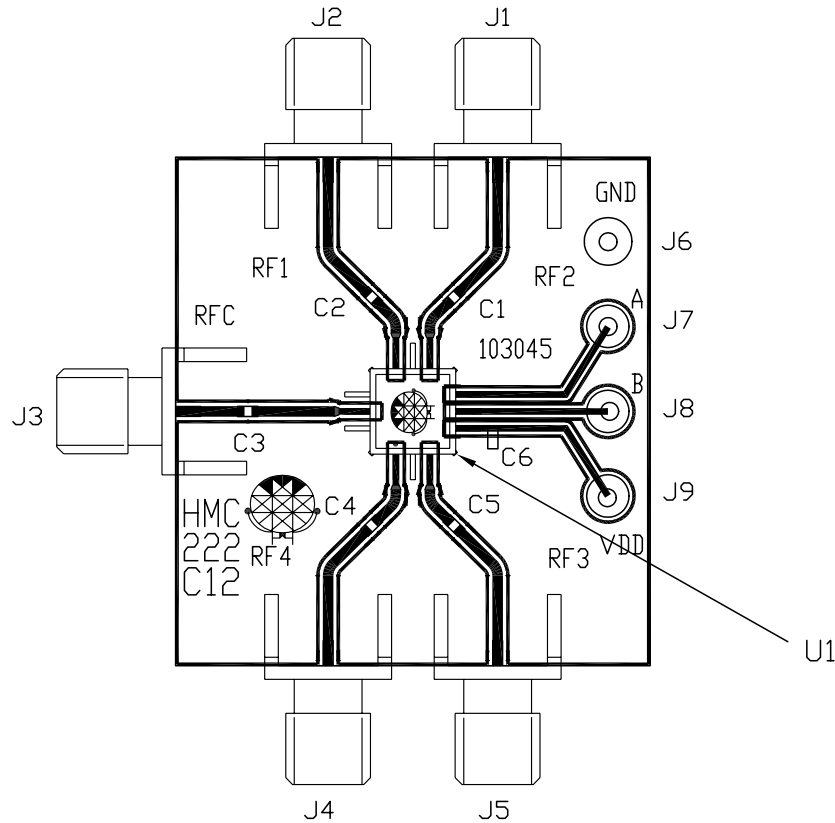

The circuit board used in the final application should be generated with proper RF circuit design techniques. Signal lines at the RF ports should have 50 ohm impedance and the package ground leads and exposed ground paddle should be connected directly to the ground similar to that shown above. The evaluation circuit board shown above is available from Hittite Microwave Corporation upon request.

List of Material

Item	Description
J1 - J5	PC Mount SMA Connector
J6 - J9	DC Pin
C1 - C5	100pF Capacitor, 0402 Pkg.
C6	0.01uF Capacitor, 0603 Pkg.
U1	HMC222C12 SP4T Switch
PCB*	103045 Evaluation PCB 1.4" x 1.5"
* Circuit Board Material: Rogers 4350	

GaAs MMIC SP4T NON-REFLECTIVE SWITCH, DC - 7.0 GHz

Notes: