



Spec. No.	PS-ND-0712
Rev.	A

PRODUCT SPECIFICATION

Model No : CSS-5160A9/CSS-5161A9

Descriptions:

- 0.50 Inch Single Digit Alphanumeric Display
- Emitting Color: Super-Bright Amber



CUSTOMER APPROVED	APPROVED BY	CHECKED BY	PREPARED BY
SIGNATURES			

CHINA SEMICONDUCTOR CORPORATION
Address:2FL. NO.909,Chung-Cheng Road,
Chung-Ho City Taipei Hsien,Taiwan.

Tel:886-2-2223-9696
Fax:886-2-2223-9377

OPTO PLUS TECHNOLOGIES CO.,LTD
Address:696 Shun jiang Rd.,Ji Shan St.Shaoxing,
ZheJiang,China

Tel:86-0575-8623888
Fax:86-0575-8623112



Spec. No.	PS-ND-0712
Rev.	A

Model No : CSS-5160A9/5161A9

Features -

1. 0.50 inch (12.7 mm) digit height.
2. Case mold type.
3. RoHs compliant.
4. Low power consumption.
5. Easy mounting on P.C. board or socket.

Device Selection Guide -

Part No.	Chip		Description
	Material	Emitted Color	
CSS-5160A9	AlGaInP	Super-Bright Amber	Common Anode
CSS-5161A9			Common Cathode

Package Dimensions -

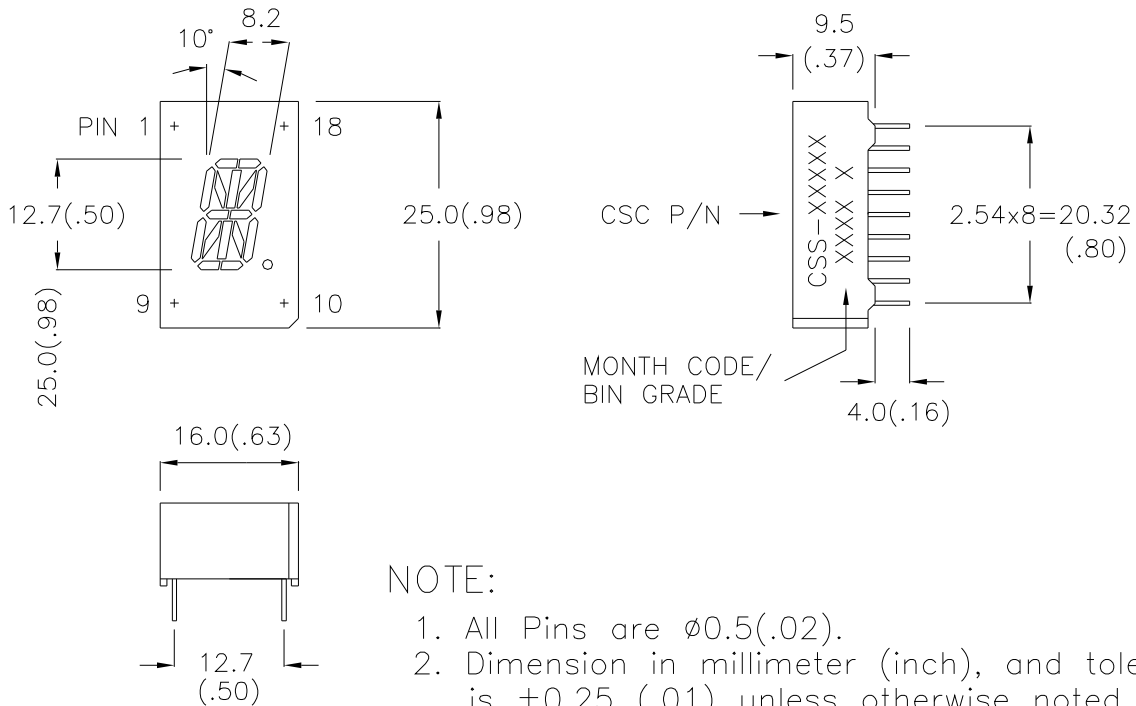

NOTE:

1. All Pins are $\phi 0.5(.02)$.
2. Dimension in millimeter (inch), and tolerance is $\pm 0.25 (.01)$ unless otherwise noted.



Model No : CSS-5160A9/5161A9

■ Internal Circuit Diagrams -

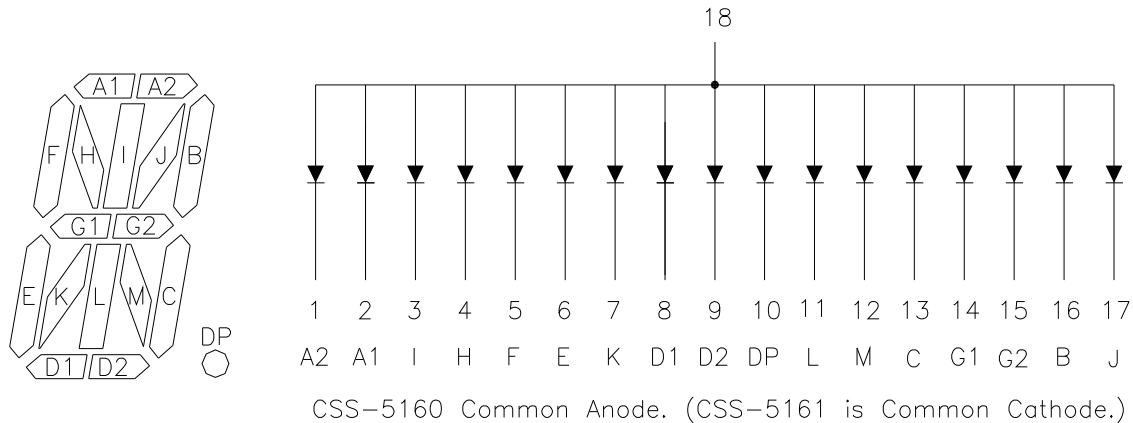

■ Absolute Maximum Rating -

(Ta=25°C)

Parameter	Symbol	Rating	Unit
Power Dissipation Per Dice	Pd	65	mW
Continuous Forward Current Per Dice	IAF	25	mA
Peak Current Per Dice (duty cycle 1/10, 1kHz)	IPF	90	mA
Derating Linear From 25°C Per Dice	-	0.33	mA/°C
Reverse Voltage Per Dice	VR	5	V
Operating Temperature	Topr	-25 ~ +85	°C
Storage Temperature	Tstg	-25 ~ +85	°C
Solder temperature 1/16 inch below seating plane for 3 seconds at 260 °C			



Spec. No.	PS-ND-0712
Rev.	A

Model No : CSS-5160A9/5161A9

■ Electro-optical Characteristics -

(Ta=25°C)

Parameter	Symbol	Min.	Typ.	Max.	Unit	Condition
Forward Voltage Per Segment	VF	-	2.0	2.6	V	IF=20mA
Luminous Intensity Per Segment	Iv	-	20	-	mcd	IF=10mA
Peak Emission Wavelength	λ_p	-	612	-	nm	IF=20mA
Spectrum Radiation Bandwidth	$\Delta \lambda$	-	20	-	nm	IF=20mA
Reverse Current	IR	-	-	100	μA	VR=5V
Luminous Intensity Matching Ratio	IV-m	-	-	2 : 1	-	IF=20mA



Spec. No.	PS-ND-0712
Rev.	A

Model No : CSS-5160A9/5161A9

Typical Electrical / Optical Characteristics Curves -

($T_a = 25^\circ\text{C}$ Unless Otherwise Noted)

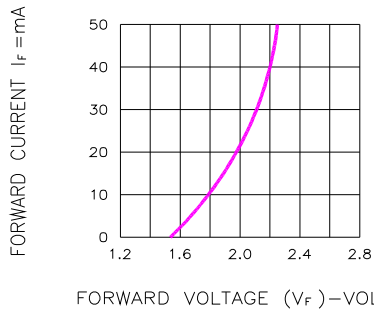

Fig.1 FORWARD CURRENT VS. FORWARD VOLTAGE

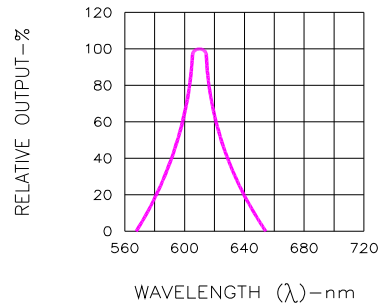

Fig.2 SPECTRAL RESPONSE

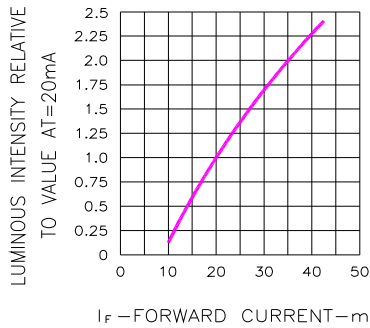

Fig.3 RELATIVE LUMINOUS INTENSITY VS. FORWARD CURRENT

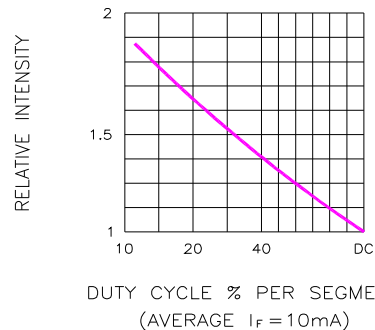

Fig.5 LUMINOUS INTENSITY VS. DUTY CYCLE

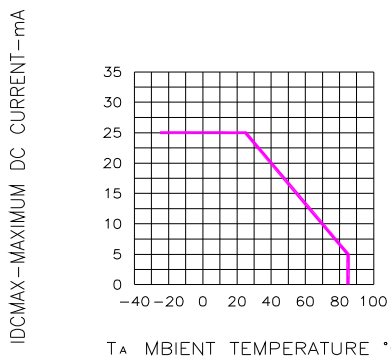

Fig.4 MAXIMUM ALLOWABLE DC CURRENT PER SEGMENT VS. A FUNCTION OF AMBIENT TEMPERATURE

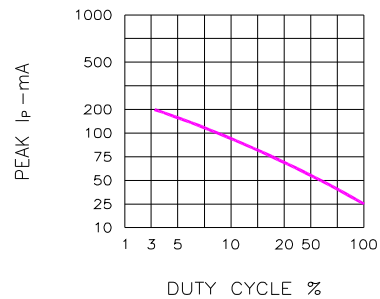

Fig.6 MAX PEAK CURRENT VS. DUTY CYCLE % (REFRESH RATE $f=1\text{KHz}$)



Spec. No.	PS-ND-0712
Rev.	A

Model No : CSS-5160A9/5161A9

■ Package Dimensions

S = Single Digit Display
Dice Code
CSS-516xX-XX
Segment Resin Color Code.
Surface silk Screen Ink Code.

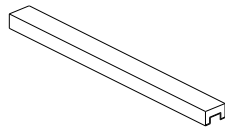

1 TUBE From Box = 20 PCS

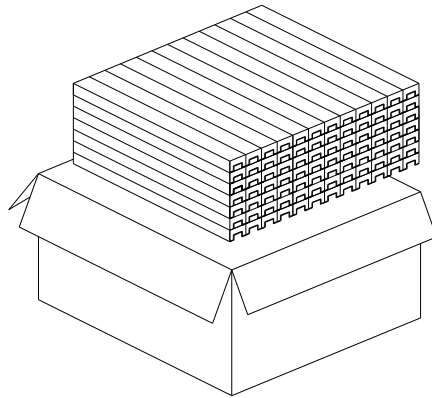

1 BOX= 60 TUBE From Box
Q'TY: 1200 PCS.



1 CARTON = 3 BOX.
Q'TY: 3600 PCS.

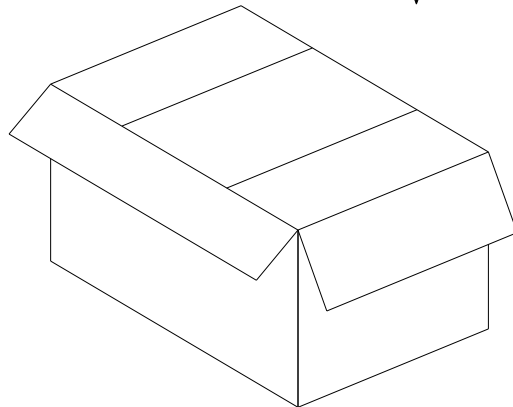

CARTON SIZE:
L540xW485xH305mm

Note: The specifications are subject to change without notice. Please contact us for updated information.