



Spec. No.	PS-ND-08090304
Rev.	A

PRODUCT SPECIFICATION

Model No: CSM-88138G/88148G

Descriptions:
<ul style="list-style-type: none"> • 1.85 Inch 8X8 Dot-Matrix Display • Dot Pitch 6.0mm • CSM-88138: Column Anode, Row Cathode • CSM-88148: Column Cathode, Row Anode • Emitting Color: Super Bright Blue



CUSTOMER APPROVED SIGNATURES	APPROVED BY	CHECKED BY	PREPARED BY

CHINA SEMICONDUCTOR CORPORATION
Address: 2FL, NO.909, Chung-Cheng Road,
Chung-Ho City Taipei Hsien, Taiwan.

Tel: 886-2-2223-9696
Fax: 886-2-2223-9377

OPTO PLUS TECHNOLOGIES CO.,LTD
Address: 696 Shun jiang Rd., Ji Shan St. Shaoxing,
ZheJiang, China

Tel: 86-0575-88623888
Fax: 86-0575-88623112



Model No : CSM-88138G/88148G

Features -

1. 1.85 inch (47.0mm) Matrix height.
2. 8x8 array with X-Y select.
3. RoHS compliant.
4. Low power consumption.
5. Easy mounting on P.C. board or socket.

Device Selection Guide -

Part No.	Chip		Description	
	Material	Emitted Color	Column	Row
CSM-88138G	GaP	Yellow Green	Anode	Cathode
CSM-88148G	GaP	Yellow Green	Cathode	Anode

Package Dimensions -

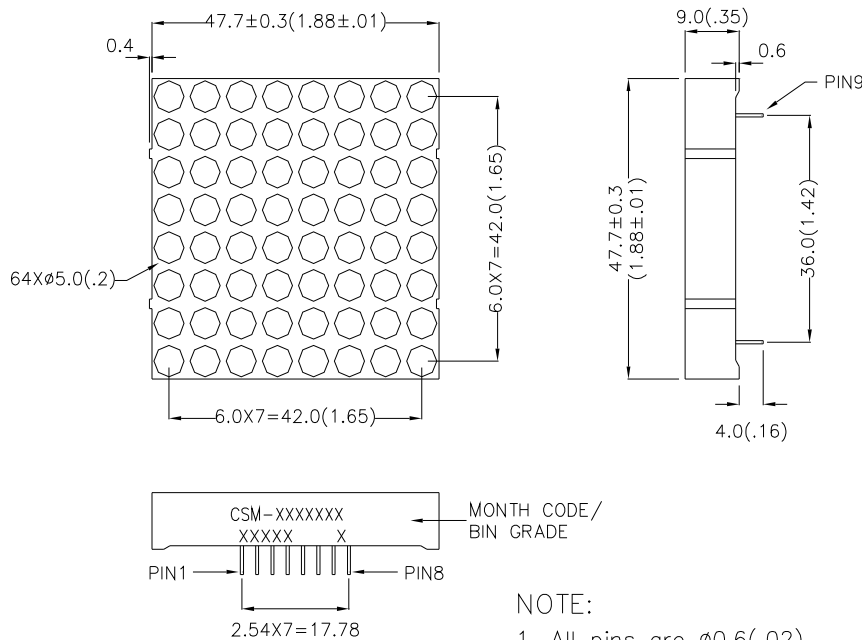

NOTE:

1. All pins are $\phi 0.6$ (.02).
2. Dimensions in millimeters (inch), tolerance is ± 0.25 (.01) unless otherwise noted.



Model No : CSM-88138G/88148G

Internal Circuit Diagrams -

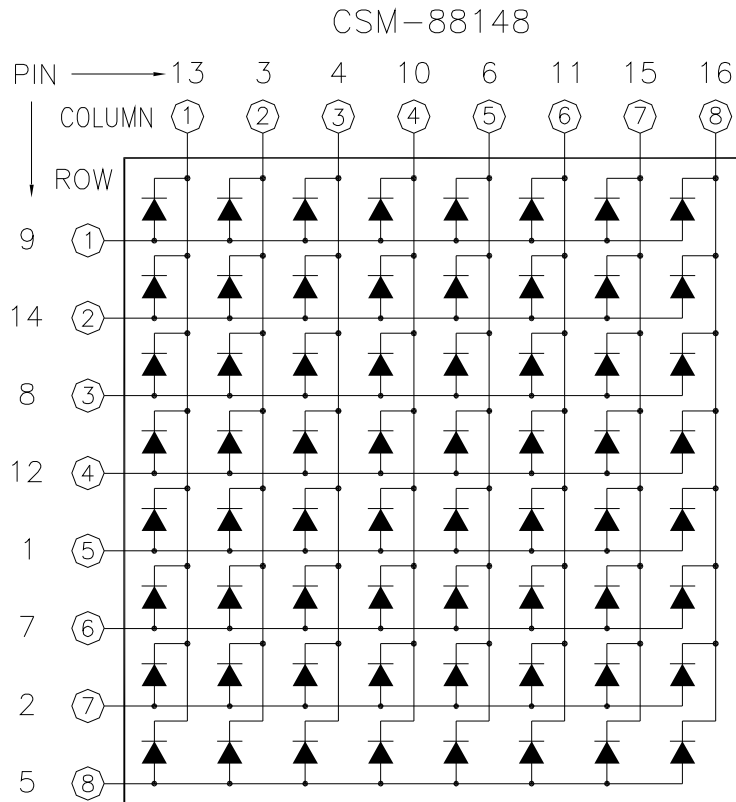

CSM-88138			CSM-88148		
PIN NO.	FUNCTION	PIN NO.	FUNCTION	PIN NO.	FUNCTION
1	Cathode Row 5	9	Cathode Row 1	1	Anode Row 5
2	Cathode Row 7	10	Anode Column 4	2	Anode Row 7
3	Anode Column 2	11	Anode Column 6	3	Cathode Column 2
4	Anode Column 3	12	Cathode Row 4	4	Cathode Column 3
5	Cathode Row 8	13	Anode Column 1	5	Anode Row 8
6	Anode Column 5	14	Cathode Row 2	6	Cathode Column 5
7	Cathode Row 6	15	Anode Column 7	7	Anode Row 6
8	Cathode Row 3	16	Anode Column 8	8	Anode Row 3
				9	Anode Row 1
				10	Cathode Column 4
				11	Cathode Column 6
				12	Anode Row 4
				13	Cathode Column 1
				14	Anode Row 2
				15	Cathode Column 7
				16	Cathode Column 8



Model No : CSM-88138G/88148G

■ Absolute Maximum Rating -

(Ta=25°C)

Parameter	Symbol	Rating	Unit
Power Dissipation Per Dice	PAD	70	mW
Continuous Forward Current Per Dice	IAF	25	mA
Peak Current Per Dice(duty cycle 1/10,1KHz)	IPF	90	mA
Derating Linear From 25°C Per Dice	-	0.33	mA/°C
Reverse Voltage Per Dice	VR	5	V
Operating Temp.	Topr	-35 ~ +85	°C
Storage Temp.	Tstg	-35 ~ +85	°C
Solder temperature 1/16 inch below seating plane for 3 seconds at 260°C			

■ Electro-optical Characteristics -

(Ta=25°C)

Parameter	Symbol	Min.	Typ.	Max.	Unit	Condition
Forward Voltage Per Dot	VF	-	2.1	2.8	V	IF=20mA
Luminous Intensity Per Dot	Iv	-	7	-	mcd	IF=10mA
Peak Emission Wavelength	λ_p	-	568	-	nm	IF=20mA
Dominant Wavelength	λ_d	-	572	-	nm	IF=20mA
Spectrum Radiation Bandwidth	$\Delta \lambda$	-	30	-	nm	IF=20mA
Reverse Current	IR	-	-	100	μA	VR=5V
Luminous Intensity Matching Ratio	IV-m	-	-	2:1	-	Ip=80mA 1/16Duty



Spec. No.	PS-ND-08090304
Rev.	A

Model No: CSM-88138G/88148G

■ Typical Electrical / Optical Characteristics Curves -

(Ta = 25°C Unless Otherwise Noted)

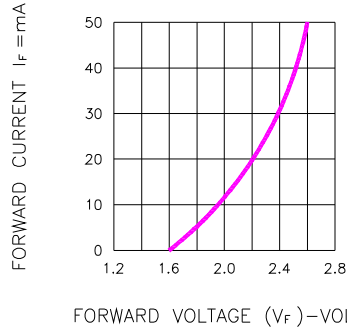

Fig.1 FORWARD CURRENT VS. FORWARD VOLTAGE

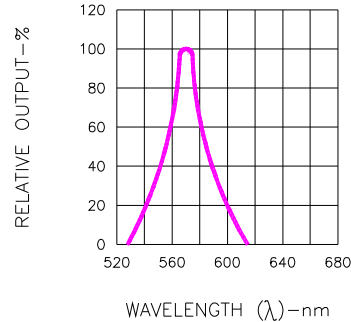

Fig.2 SPECTRAL RESPONSE

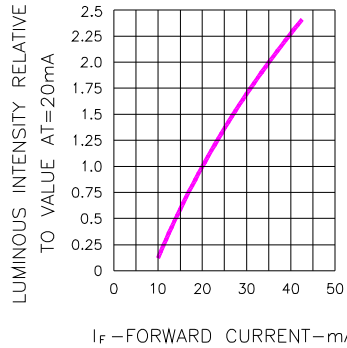

Fig.3 RELATIVE LUMINOUS INTENSITY VS. FORWARD CURRENT

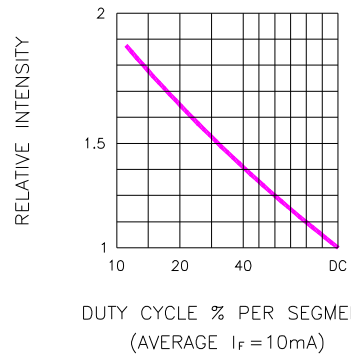

Fig.5 LUMINOUS INTENSITY VS. DUTY CYCLE

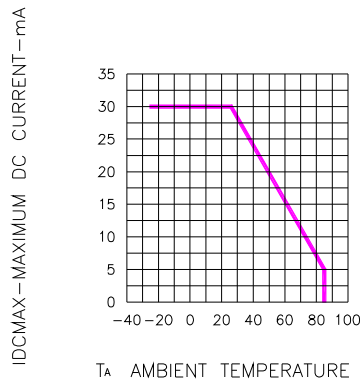

Fig.4 MAXIMUM ALLOWABLE DC CURRENT PER SEGMENT VS. A FUNCTION OF AMBIENT TEMPERATURE

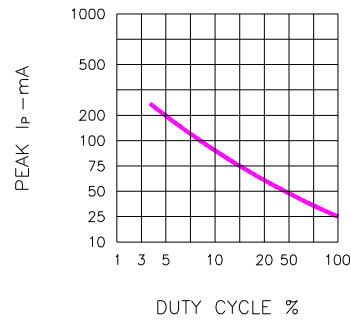

Fig.6 MAX PEAK CURRENT VS. DUTY CYCLE % (REFRESH RATE f=1 KHz)



Spec. No.	PS-ND-08090304
Rev.	A

Model No: CSM-88138G/88148G

■ Package Dimensions

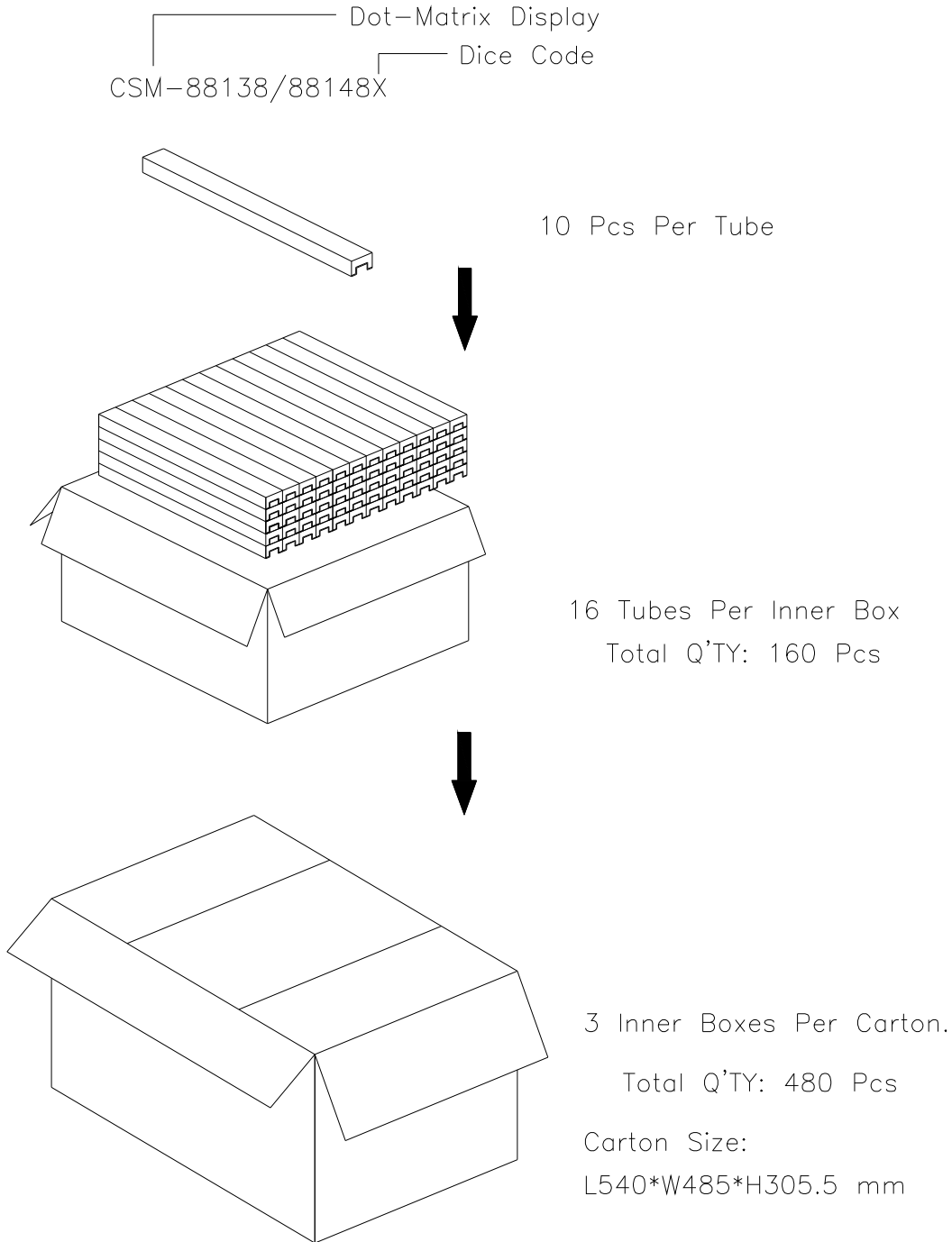

Note: The specifications are subject to change without notice. Please contact us for updated information.