

ASDL-5772

High Performance Photodiode in Side Look Package



Data Sheet

Description

ASDL-5772 is a Silicon PIN Photodiode encapsulated in dark green Side Look package. The added feature of a dark tint acts as an optical filter to reduce effects of ambient light from interfering with the Infrared signal. It is ideal for applications from 700nm to 1100nm that require high sensitivity over wide viewing angle.

Features

- Dark Green Side Look Package
- High Sensitivity
- Low Dark Current
- Low Junction Capacitance
- Wide viewing Angle
- Lead Free & ROHS Compliant
- Available in Tape & Reel

Applications

- IR Remote Control for Consumer Device
- IR Remote Control for Industrial Electronics & Equipment
- High Speed IR data communication

Ordering Information

Part Number	Lead Form	Color	Packaging	Shipping Option
ASDL-5772-D22	Straight	Dark Green	Tape & Reel	4000pcs
ASDL-5772-D31			Bulk	8000pcs / Carton

Package Dimensions

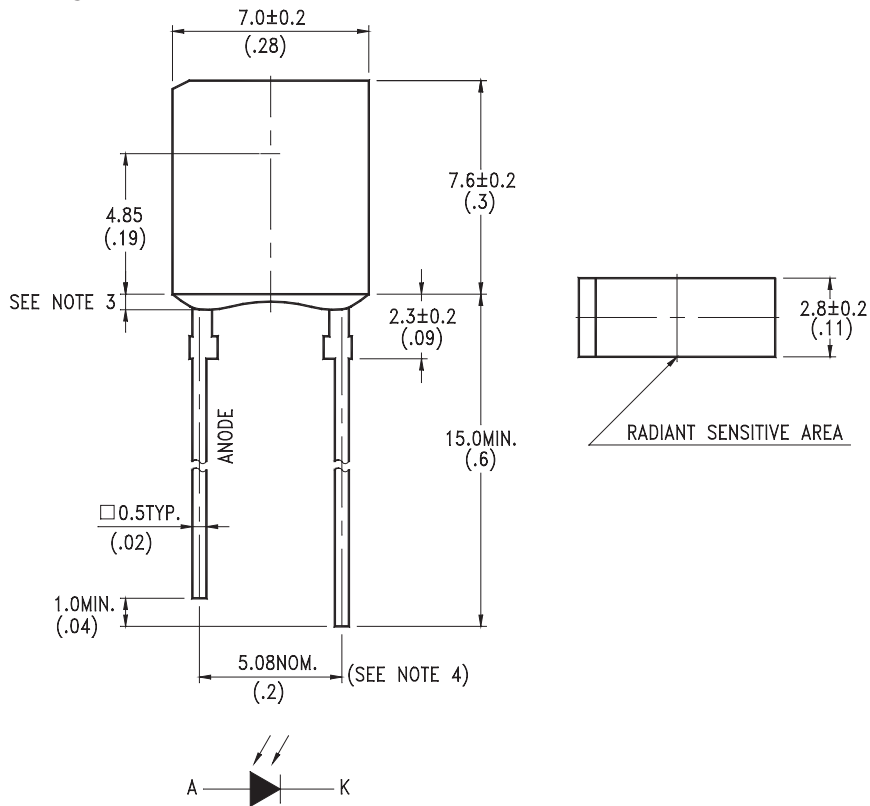

Notes:

1. All dimensions are in millimeters (inches)
2. Tolerance is + 0.25mm (.010") unless otherwise noted
3. Protuded resin under flange is 1.5mm (.059") max
4. Lead spacing is measured where leads emerge from package
5. Specifications are subject to change without notice.

Absolute Maximum Ratings at $T_A=25^\circ\text{C}$

Parameter	Symbol	Min.	Max	Unit
Power Dissipation	P_{DISS}		150	mW
Reverse Voltage ($I_R=100\mu\text{A}$)	V_R		30	V
Operating Temperature	T_O	-40	85	$^\circ\text{C}$
Storage Temperature	T_S	-55	100	$^\circ\text{C}$
Junction temperature	T_J		110	$^\circ\text{C}$
Lead Soldering Temperature [.6mm (0.063") From Body]		260 $^\circ\text{C}$ for 5 seconds		

Electrical Characteristics at 25°C

Parameter	Symbol	Min.	Typ.	Max.	Unit	Condition
Forward Voltage	V_F		1	1.3	V	$I_F = 50\text{mA}$
Breakdown Voltage	V_{BR}	30			V	$I_R = 100\mu\text{A}$ $E_e = 0\text{mW}/\text{cm}^2$
Reverse Dark Current	I_D			30	nA	$V_R = 10\text{V}$ $E_e = 0\text{mW}/\text{cm}^2$
Diode Capacitance	C_0	-	25		pF	$V_R = 3\text{V}$ $F = 1\text{MHZ}$ $E_e = 0\text{mW}/\text{cm}^2$
Open Circuit Voltage	V_{OC}		350		mV	$\lambda = 940\text{nm}$ $E_e = 0.5\text{mW}/\text{cm}^2$
Thermal Resistance, Junction to Pin	$R_{\theta JP}$	-	375		$^\circ\text{C}/\text{W}$	

Optical Characteristics at 25°C

Parameter	Symbol	Min.	Typ.	Max.	Unit	Condition
Photocurrent	I_{PH}	1.7	2		μA	$E_e = 0.1\text{mW}/\text{cm}^2$ $\lambda = 940\text{nm}$ $V_r = 5\text{V}$
Radiant Sensitive Area	A		1.55		mm^2	
Absolute Spectral Sensitivity	S		0.6		A/W	$\lambda = 940\text{nm}$ $V_r = 5\text{V}$
Viewing Angle	$2\theta_{1/2}$		140		Deg	
Wavelength of Peak sensitivity	λ_{PK}		900		nm	
Spectral BandWidth	$\Delta\lambda$	700	900	1100	nm	
Rise Time	t_r		50		ns	$V_R = 10\text{V}$ $\lambda = 850\text{nm}$ $R_L = 1\text{K}\Omega$
Fall Time	t_f		50		ns	$V_R = 10\text{V}$ $\lambda = 850\text{nm}$ $R_L = 1\text{K}\Omega$

Typical Electrical/Optical Characteristics Curves ($T_A=25^\circ\text{C}$ unless otherwise indicated)

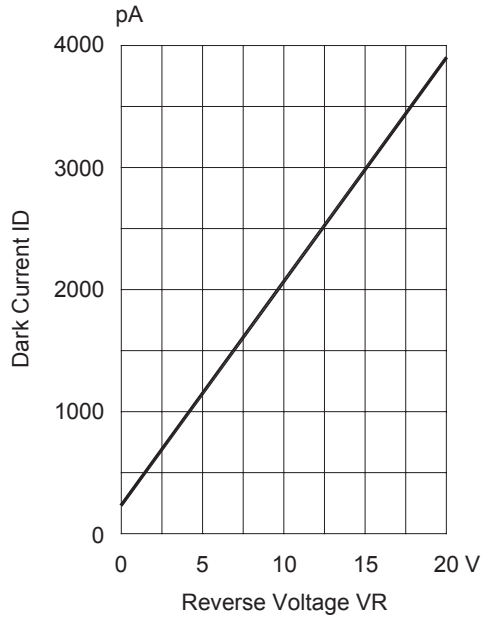

Figure 1. DARK CURRENT VS. REVERSE VOLTAGE
 $T_A=25^\circ\text{C}$, $E_e=0\text{ mW/cm}^2$

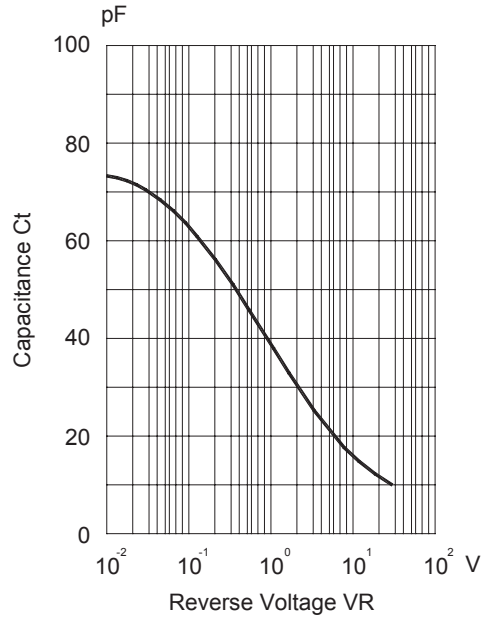

Figure 2. CAPACITANCE VS. REVERSE VOLTAGE
 $F=1\text{MHz}$; $E_e=0\text{mW/cm}^2$

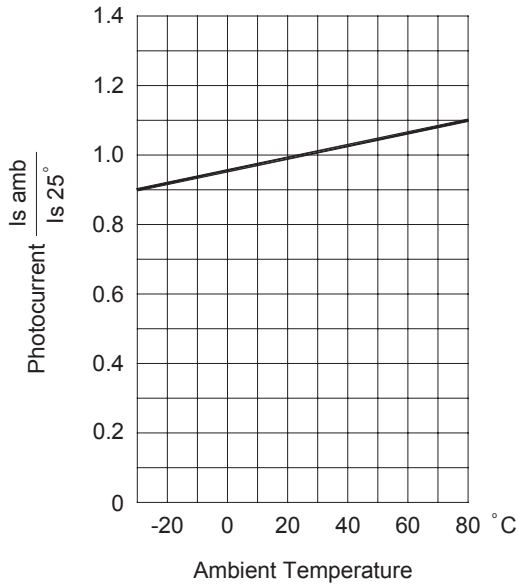

Figure 3. PHOTOCURRENT VS. AMBIENT TEMPERATURE

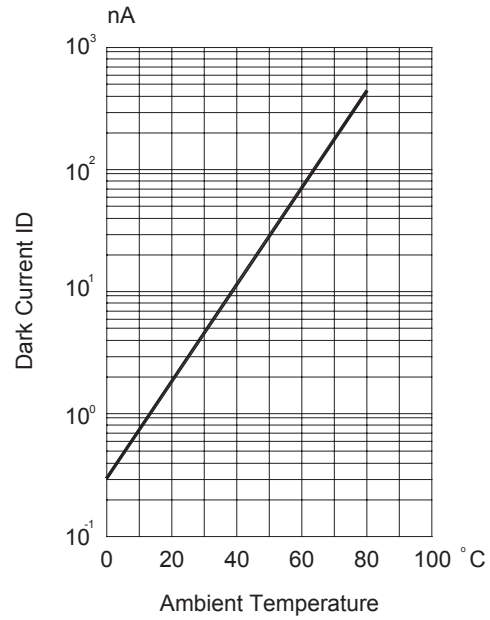

Figure 4. DARK CURRENT VS. AMBIENT TEMPERATURE
 $VR=10$, $E_e=0\text{mW/cm}^2$

Typical Electrical/Optical Characteristics Curves ($T_A=25^\circ\text{C}$ unless otherwise indicated) Cont.

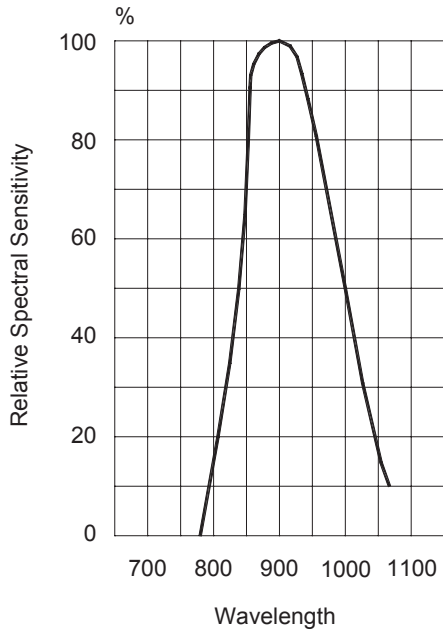

Figure 5. RELATIVE SPECTRAL SENSITIVITY VS WAVELENGTH

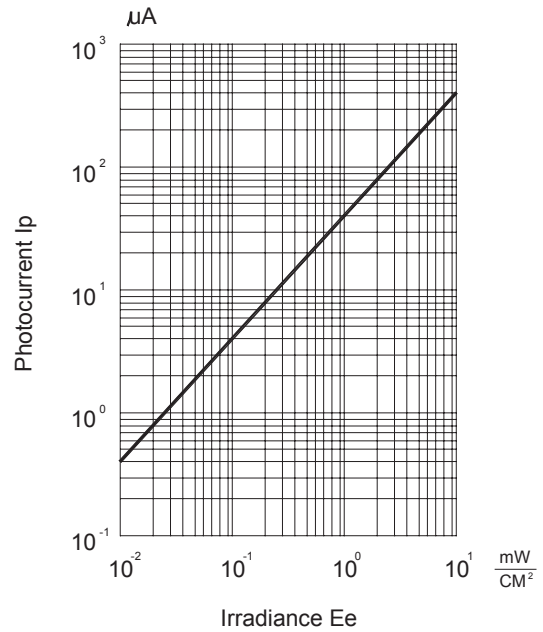

Figure 6. PHOTOCURRENT VS IRRADIANCE $\lambda = 940 \text{ nm}$

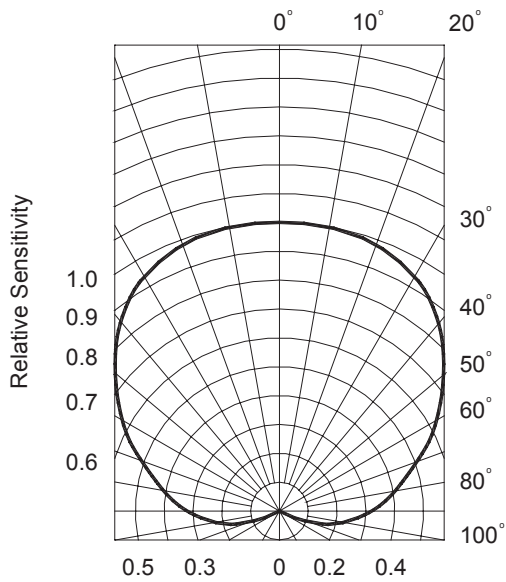

Figure 7. SENSITIVITY DIAGRAM

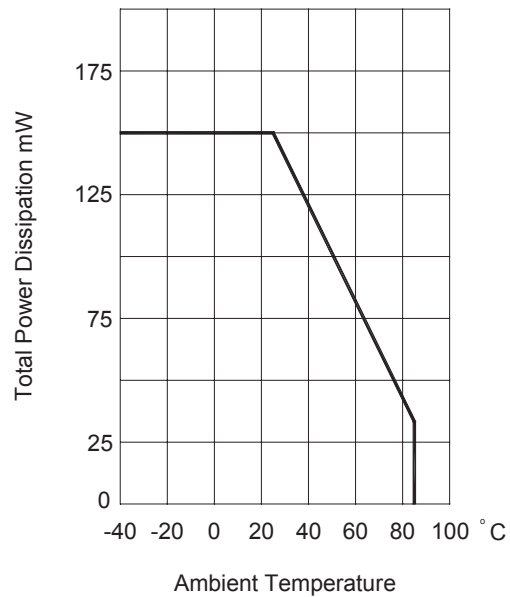

Figure 8. TOTAL POWER DISSIPATION VS AMBIENT TEMPERATURE

For product information and a complete list of distributors, please go to our web site: www.avagotech.com

Avago, Avago Technologies, and the A logo are trademarks of Avago Technologies, Limited in the United States and other countries. Data subject to change. Copyright © 2007 Avago Technologies Limited. All rights reserved. AV02-0023EN - January 22, 2007

AVAGO
TECHNOLOGIES