



# 12-Bit + Sign Digital Temperature Sensors with Serial Interface

## General Description

The MAX6629–MAX6632 are local digital temperature sensors with an SPI™-compatible serial interface. The temperature is converted to a 12-bit + sign word with a resolution of 0.0625°C/LSB. An extended temperature range provides useful readings up to +150°C.

These sensors are 3-wire serial interface SPI compatible, allowing the MAX6629–MAX6632 to be readily connected to a variety of microcontrollers (μCs). The MAX6629–MAX6632 are read-only devices, simplifying their use in systems where only temperature data is required.

All four digital temperature sensors require very little supply current, making them ideal for portable systems. The MAX6631/MAX6632 perform a temperature-to-digital conversion once every 8s and require minimal average supply current, 32μA (typ). The MAX6629/MAX6630 perform a conversion once every 0.5s and require only 200μA (typ) supply current. Any of these temperature sensors can perform conversions more often—up to approximately four conversions per second by reading the conversion results more often.

## Applications

Cellular	Automotive
Hard Disk Drive	Industrial Control Systems
HVAC	

SPI is a trademark of Motorola, Inc.

## Typical Application Circuit



## Features

- ◆ **Low Power Consumption**  
32μA typ (MAX6631/MAX6632)  
200μA typ (MAX6629/MAX6630)
- ◆ **12-Bit + Sign Resolution with 0.0625°C/LSB**
- ◆ **Accuracy**  
±1°C (max) from 0°C to +70°C
- ◆ **+150°C Extended Temperature Range**
- ◆ **SPI-Compatible Serial Interface**
- ◆ **+3.0V to +5.5V Supply Range**
- ◆ **6-Pin TDFN and SOT23 Packages**
- ◆ **Lead-Free Version Available (TDFN Package)**

## Ordering Information

PART	TEMP RANGE	PIN-PACKAGE
<b>MAX6629MTT+</b>	-55°C to +125°C	6 TDFN-EP*
MAX6629MUT	-55°C to +125°C	6 SOT23-6
<b>MAX6630MTT+</b>	-55°C to +125°C	6 TDFN-EP*
MAX6630MUT	-55°C to +125°C	6 SOT23-6
<b>MAX6631MTT+</b>	-55°C to +125°C	6 TDFN-EP*
MAX6631MUT	-55°C to +125°C	6 SOT23-6
<b>MAX6632MTT+</b>	-55°C to +125°C	6 TDFN-EP*
MAX6632MUT	-55°C to +125°C	6 SOT23-6

+ Denotes a lead(Pb)-free/RoHS-compliant package.

\*EP = Exposed pad.

## Pin Configurations

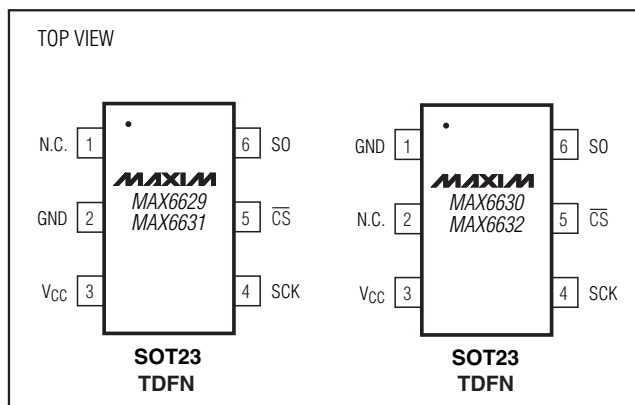

# 12-Bit + Sign Digital Temperature Sensors with Serial Interface

## ABSOLUTE MAXIMUM RATINGS

All Voltages Referenced to GND

V <sub>CC</sub> .....	-0.3V, +6.0V
SO, SCK, $\overline{CS}$ .....	-0.3V, V <sub>CC</sub> + 0.3V
SO.....	-1mA to +50mA
Current into Any Pin.....	10mA
Continuous Power Dissipation (T <sub>A</sub> = +70°C)	
6-Pin SOT23 (derate 9.10mW/°C above +70°C).....	727mW
6-Pin TDFN (derate 24.4mW/°C above +70°C).....	1951mW

Junction Temperature.....	+150°C
Operating Temperature Range (Note 1).....	-55°C to +150°C
Storage Temperature Range.....	-65°C to +150°C
Lead Temperature (soldering, 10s).....	+300°C
Soldering Temperature (reflow)	
TDFN.....	+260°C
SOT23 (Ordering Information contains "#").....	+245°C
SOT23 (Ordering Information contains "-").....	+240°C

**Note:** It is not recommended to operate the device above +125°C for extended periods of time.

Stresses beyond those listed under "Absolute Maximum Ratings" may cause permanent damage to the device. These are stress ratings only, and functional operation of the device at these or any other conditions beyond those indicated in the operational sections of the specifications is not implied. Exposure to absolute maximum rating conditions for extended periods may affect device reliability.

## ELECTRICAL CHARACTERISTICS

(V<sub>CC</sub> = +3.0V to +5.5V, T<sub>A</sub> = -55°C to +125°C, unless otherwise noted. Typical values are at V<sub>CC</sub> = +3.3V and T<sub>A</sub> = +25°C.) (Notes 2 and 3)

PARAMETER	SYMBOL	CONDITIONS	MIN	TYP	MAX	UNITS
<b>TEMPERATURE</b>						
Accuracy		T <sub>A</sub> = room temp, V <sub>CC</sub> = +3.3V	-0.8	±0.2	+0.8	°C
		0°C ≤ T <sub>A</sub> ≤ +70°C, V <sub>CC</sub> = +3.3V	-1.0	±0.2	+1.0	
		-20°C ≤ T <sub>A</sub> ≤ +85°C, V <sub>CC</sub> = +3.3V	-1.6	+0.3	+1.6	
		-20°C ≤ T <sub>A</sub> ≤ +100°C, V <sub>CC</sub> = +3.3V	-2.3	+0.5	+2.3	
		-40°C ≤ T <sub>A</sub> ≤ +125°C, V <sub>CC</sub> = +3.3V	-3.2	+0.8	+3.2	
		T <sub>A</sub> ≥ -55°C, V <sub>CC</sub> = +3.3V	-1.0	+1.5	+3.5	
		T <sub>A</sub> = +150°C, V <sub>CC</sub> = +3.3V	-5.0	+1.5	+6.5	
Power-Supply Sensitivity	PSS			0.2	0.6	°C/V
Resolution			0.0625			°C
Time Between Conversion Starts	t <sub>SAMPLE</sub>	MAX6629, MAX6630, $\overline{CS}$ high	0.37	0.5	0.65	s
		MAX6631, MAX6632, $\overline{CS}$ high	5.9	8	10.5	
Conversion Time	t <sub>CONV</sub>		180	250	320	ms
<b>POWER SUPPLY</b>						
Supply Voltage Range	V <sub>CC</sub>		3.0		5.5	V
Supply Current, SCK Idle	I <sub>SD</sub>	Shutdown (Note 3), V <sub>CC</sub> = +0.8V			5	μA
	I <sub>IDLE</sub>	ADC idle (Figure 2), $\overline{CS}$ = low		6	20	
	I <sub>CONV</sub>	ADC converting (Figure 2)		360	650	
Average Operating Current	I <sub>CC</sub>	MAX6629, MAX6630		200	400	μA
		MAX6631, MAX6632		32	50	
Power-On Reset (POR) Threshold		V <sub>CC</sub> falling		1.6		V

# 12-Bit + Sign Digital Temperature Sensors with Serial Interface

MAX6629-MAX6632

## ELECTRICAL CHARACTERISTICS (continued)

( $V_{CC} = +3.0V$  to  $+5.5V$ ,  $T_A = -55^{\circ}C$  to  $+125^{\circ}C$ , unless otherwise noted. Typical values are at  $V_{CC} = +3.3V$  and  $T_A = +25^{\circ}C$ .) (Notes 2 and 3)

PARAMETER	SYMBOL	CONDITIONS	MIN	TYP	MAX	UNITS
<b>LOGIC INPUTS (<math>\overline{CS}</math>, SCK)</b>						
Logic Input Low Voltage	$V_{IL}$				$0.3 \times V_{CC}$	V
Logic Input High Voltage	$V_{IH}$		$0.7 \times V_{CC}$			V
Input Leakage Current	$I_{LEAK}$	$V_{IN} = V_{GND}$ or $+5.5V$		$\pm 1$	$\pm 5$	$\mu A$
<b>LOGIC OUTPUTS (SO)</b>						
Output Low Voltage	$V_{OL}$	$I_{SINK} = 1.6mA$			0.4	V
Output High Voltage	$V_{OH}$	$I_{SOURCE} = 1.6mA$	$V_{CC} - 0.4$			V
<b>TIMING CHARACTERISTICS (Notes 4 and 5)</b>						
Serial Clock Frequency	$f_{SCL}$				5	MHz
SCK Pulse Width High	$t_{CH}$		100			ns
SCK Pulse Width Low	$t_{CL}$		100			ns
$\overline{CS}$ Fall to SCK Rise	$t_{CSS}$	$C_{LOAD} = 10pF$	80			ns
$\overline{CS}$ Fall to Output Enable	$t_{DV}$	$C_{LOAD} = 10pF$			80	ns
$\overline{CS}$ Rise to Output Disable	$t_{TR}$	$C_{LOAD} = 10pF$			50	ns
SCK Fall to Output Data Valid	$t_{DO}$	$C_{LOAD} = 10pF$			80	ns

**Note 2:** Tested at a single temperature. Specifications over temperature are guaranteed by design.

**Note 3:** The MAX6629-MAX6632 are not specifically equipped with a shutdown function. Their low supply current permits powering them from the output of a logic gate. This specification is given to ensure that the MAX6629-MAX6632 do not draw excessive currents at low supply voltages, ensuring reliable operation from a gate output.

**Note 4:** Timing characteristics are guaranteed by design and are not production tested.

**Note 5:**  $C_{LOAD}$  = total capacitance of one bus line in picofarads.

# 12-Bit + Sign Digital Temperature Sensors with Serial Interface

## Typical Operating Characteristics

( $V_{CC} = +3.3V$ ,  $T_A = +25^\circ C$ , unless otherwise noted.)

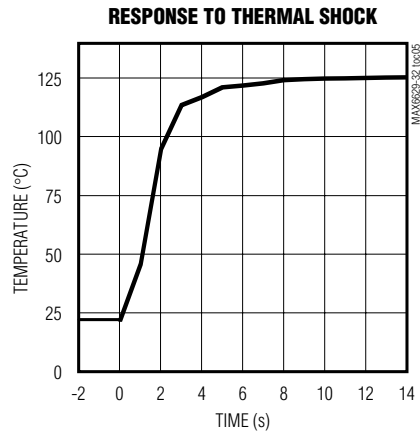
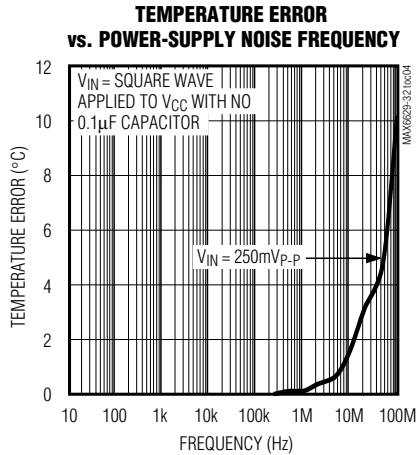
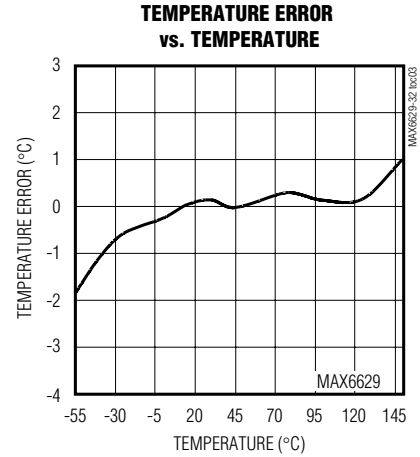
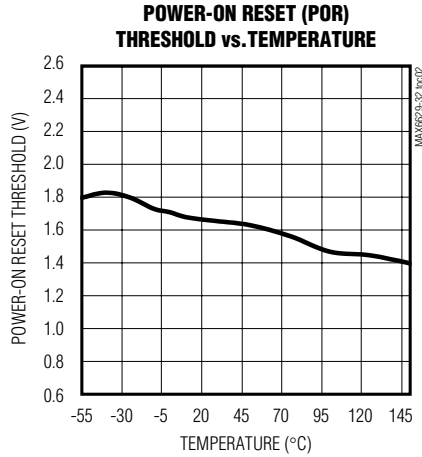
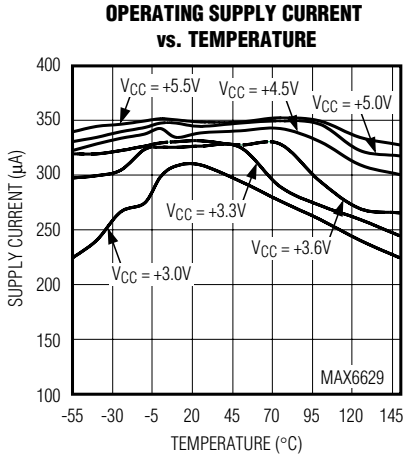

## Pin Description

PIN		NAME	FUNCTION
MAX6629 MAX6631	MAX6630 MAX6632		
1	2	N.C.	No Connect. Connect to ground plane for better thermal performance to the PC board.
2	1	GND	Ground
3	3	$V_{CC}$	Supply Voltage Input. Bypass $V_{CC}$ to GND with a 0.1µF capacitor. $V_{CC}$ can also be powered from a logic output as long as the voltage level is greater than 3.0V and the logic output is not noisy. Setting the logic output low provides a hardware shutdown mode.
4	4	SCK	Serial Clock Input
5	5	$\overline{CS}$	Chip-Select Input. Enables the interface. A rising edge off $\overline{CS}$ initiates the next conversion. Pulling $\overline{CS}$ low initiates an idle state.
6	6	SO	Serial Data Output
—	—	EP	Exposed Pad (TDFN only). Connect to GND or leave unconnected.

# 12-Bit + Sign Digital Temperature Sensors with Serial Interface

MAX6629-MAX6632

## Detailed Description

The MAX6629–MAX6632 are local digital temperature sensors with a serial bus. The MAX6629–MAX6632 are typically interfaced to a  $\mu\text{C}$  in temperature sensing and control applications. The MAX6629–MAX6632 convert temperature to a 12-bit + sign word with a  $0.0625^\circ\text{C}$  LSB. The data is communicated through a simple serial interface with a  $\overline{\text{CS}}$  (chip select) line, SO (data) line, and SCK (clock) line. This interface can be directly connected to, and is fully compatible with, SPI interfaces. This interface can also be connected to virtually any processor, which has at least three general-purpose input/output (GPIO) lines available to implement software “bit banging.”

The high resolution of the MAX6629–MAX6632 makes them especially useful in thermal control loops, HVAC systems, or in any system where quick anticipation of temperature trends is useful. The MAX6629–MAX6632 can produce temperature data in excess of  $+150^\circ\text{C}$ , although they are specified for a maximum operating temperature of  $+150^\circ\text{C}$ . This extended temperature range makes it especially useful in automotive underhood applications. The low power consumption is also ideal in battery-operated and portable applications.

The MAX6631/MAX6632 are optimized for minimum power consumption with their 8s conversions. The MAX6629/MAX6630 provide faster conversions, 0.5s, at the expense of power consumption. The low quiescent supply current enables the device to be powered from a logic line or the output of a gate where the high level exceeds 3V, as shown in Figure 1. While the MAX6629–MAX6632 are not specifically equipped with a software shutdown mode, the hardware shutdown can easily be implemented by setting the gate output to low. Pulling  $\overline{\text{CS}}$  low without a clock also puts the device in idle mode. Take care to ensure that the logic output



Figure 1. Powering the Sensor from a Logic Gate

is not noisy, as excessive noise on  $V_{\text{CC}}$  can affect temperature measurement accuracy.

## ADC Conversion Sequence

The MAX6629–MAX6632 continuously convert temperature to digital data. Setting  $\overline{\text{CS}}$  low stops any conversion in progress, places the device in idle mode, and makes data available for reading. Setting  $\overline{\text{CS}}$  high starts a new conversion.  $\overline{\text{CS}}$  must remain high for at least 0.3s to allow for the conversion to be completed. Figure 2 shows the timing relationship between conversion time and conversion rate.

## SPI Digital Interface

The MAX6629–MAX6632 are compatible with SPI serial-interface standards (Figure 3) and are designed to be read-only devices.  $\overline{\text{CS}}$ 's rising edge always starts a new conversion and resets the interface.  $\overline{\text{CS}}$  must stay high for a minimum of 300ms to allow the conversion to



Figure 2. Conversion Time and Rate Relationships

# 12-Bit + Sign Digital Temperature Sensors with Serial Interface



Figure 3. SPI Timing Diagram

**Table 1. Data Output Format**

D15	D14	D13	D12	D11	D10	D9	D8	D7	D6	D5	D4	D3	D2	D1	D0
Sign	MSB Data											LSB Data	Low	High-Z	High-Z

**Table 2. Temperature Data Format (Two's Complement)**

TEMPERATURE (°C)	DIGITAL OUTPUT (BINARY)		
	D15–D3	D2	D1, D0
150	0,1001,0110,0000	0	XX
125	0,0111,1101,0000	0	XX
25	0,0001,1001,0000	0	XX
0.0625	0,0000,0000,0001	0	XX
0	0,0000,0000,0000	0	XX
-0.0625	1,1111,1111,1111	0	XX
-25	1,1110,0111,0000	0	XX
-55	1,1100,1001,0000	0	XX

finish.  $\overline{CS}$ 's falling edge stops any conversion in progress, and data is latched into the shift register. Then the data clocks out at SO on SCK's falling edge with the sign bit (D15) first, followed by the MSB. Data is sent in one 16-bit word, and  $\overline{CS}$  must remain low until all 16 bits are transferred. If  $\overline{CS}$  goes high in the middle of a transmission, it is necessary to wait the conversion time (less than 300ms) before attempting a new read. The serial data is composed of 12 + 1 data bits (D15–D3) and 3 trailing bits (D2–D0). D2 is always low, serving as the confirmation bit that the device has been communicated with. The last 2 bits, D0 and D1, are

undefined and are always in high-impedance mode (Table 1). The power-up state for SO is high impedance. Figure 3 shows the detailed serial timing specifications for the SPI port. The temperature data format is in two's complement format (Table 2).

### Power Shutdown Mode

The MAX6629–MAX6632 do not have a built-in power software shutdown mode. However, a power shutdown mode is easily implemented utilizing an unused logic gate. A typical CMOS or TTL logic output has enough drive capability to serve as the power source if its output voltage level exceeds 3V, as shown in Figure 1. Drive the logic output low to provide a hardware shutdown mode.

### Idle Mode

The MAX6629–MAX6632 can be put into idle mode by pulling  $\overline{CS}$  low. Data can be clocked out when the device is in idle mode.

### Power-On Reset (POR)

The POR supply voltage of the MAX6629–MAX6632 is typically 1.6V. Below this supply voltage, the interface is inactive and the data register is set to the POR state, 0°C.

When power is first applied and  $V_{CC}$  rises above 1.6V (typ), the device starts to convert, although temperature reading is not recommended at  $V_{CC}$  levels below 3.0V.

# 12-Bit + Sign Digital Temperature Sensors with Serial Interface

MAX6629-MAX6632

## Applications Information

### Thermal Considerations

The key to accurate temperature monitoring is good thermal contact between the MAX6629–MAX6632 package and the object being monitored. In some applications, the 6-pin SOT23 package is small enough to fit underneath a socketed  $\mu\text{P}$ , allowing the device to monitor the  $\mu\text{P}$ 's temperature directly. Accurate temperature monitoring depends on the thermal resistance between the object being monitored and the MAX6629–MAX6632 die. Heat flows in and out of plastic packages primarily through the leads. If the sensor is intended to measure the temperature of a heat-generating component on the circuit board, it should be mounted as close as possible to that component and should share supply and ground traces (if they are not noisy) with that component where possible. This maximizes the heat transfer from the component to the sensor.

The MAX6629/MAX6630 supply current is typically  $200\mu\text{A}$ , and the MAX6631/MAX6632 supply current is typically  $32\mu\text{A}$ . When used to drive high-impedance loads, the device dissipates negligible power. Therefore, the die temperature is essentially the same as the package temperature.

The rise in die temperature due to self-heating is given by the following formula:

$$\Delta T_J = P_{\text{DISSIPATION}} \times \theta_{JA}$$

where  $P_{\text{DISSIPATION}}$  is the power dissipated by the MAX6629–MAX6632, and  $\theta_{JA}$  is the package's thermal resistance.

The typical thermal resistance is  $+110^\circ\text{C}/\text{W}$  for the 6-pin SOT23 package. To limit the effects of self-heating, minimize the output currents. For example, if the MAX6629–MAX6632 sink  $1\text{mA}$ , the output voltage is guaranteed to be less than  $0.4\text{V}$ . Therefore, an additional  $0.4\text{mW}$  of power is dissipated within the IC. This corresponds to a  $0.044^\circ\text{C}$  shift in the die temperature in the 6-pin SOT23.

## Functional Diagram

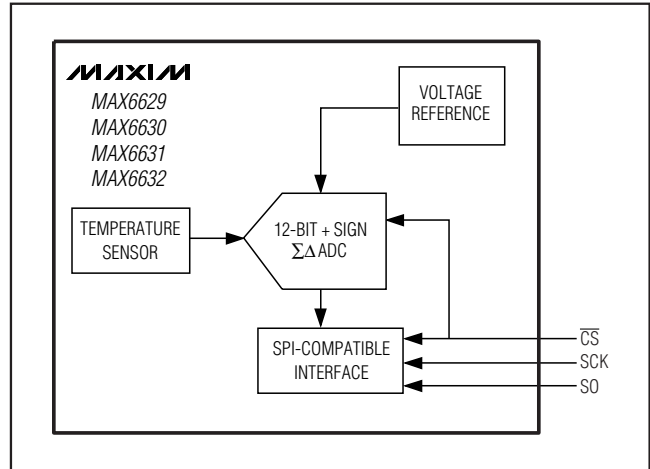

## Chip Information

PROCESS: BiCMOS

## Package Information

For the latest package outline information and land patterns, go to [www.maxim-ic.com/packages](http://www.maxim-ic.com/packages). Note that a "+", "#", or "-" in the package code indicates RoHS status only. Package drawings may show a different suffix character, but the drawing pertains to the package regardless of RoHS status.

PACKAGE TYPE	PACKAGE CODE	DOCUMENT NO.
6 SOT23	U6FH-6	<a href="#">21-0058</a>
6 TDFN-EP	T633+2	<a href="#">21-0137</a>

# 12-Bit + Sign Digital Temperature Sensors with Serial Interface

## Revision History

REVISION NUMBER	REVISION DATE	DESCRIPTION	PAGES CHANGED
0	5/01	Initial release of MAX6629	—
1	7/01	Initial release of MAX3360, MAX3361, and MAX3362; changed I <sub>CONV</sub> from 600μA (max) to 650μA (max) in the <i>Electrical Characteristics</i> table	1, 2
2	4/04	Changed the lead temperature in the <i>Absolute Maximum Ratings</i> section, replacing Note 2 with +300°C (removed the JEDEC solder reflow boiler plating due to high temp solder paste for flip chips now in production)	2
3	8/05	Added the TDFN package	1, 2, 9
4	5/10	Added "+" to TDFN packages in the <i>Ordering Information</i> table	1
		Added soldering information to the <i>Absolute Maximum Ratings</i> section	2
		Added the TDFN exposed pad information to the <i>Pin Description</i> table	4

Maxim cannot assume responsibility for use of any circuitry other than circuitry entirely embodied in a Maxim product. No circuit patent licenses are implied. Maxim reserves the right to change the circuitry and specifications without notice at any time.

8 **Maxim Integrated Products, 120 San Gabriel Drive, Sunnyvale, CA 94086 408-737-7600**