



CHENMKO ENTERPRISE CO.,LTD

Lead free devices

**SURFACE MOUNT
PNP Switching Transistor**

VOLTAGE 60 Volts CURRENT 0.6 Ampere

CHT2907WPT

APPLICATION

- * Telephony and professional communication equipment.
- * Other switching applications.

FEATURE

- * Small surface mounting type. (SC-70/SOT-323)
- * High current (Max.=600mA).
- * Suitable for high packing density.
- * Low voltage (Max.=60V) .
- * High saturation current capability.
- * Voltage controlled small signal switch.

CONSTRUCTION

- * PNP Switching Transistor

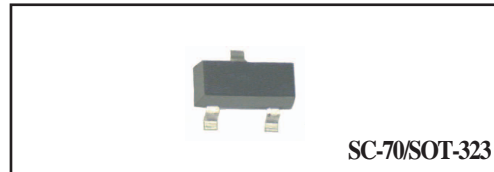

SC-70/SOT-323

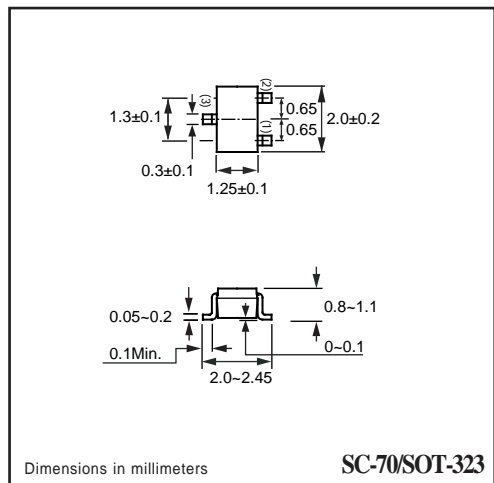

CIRCUIT

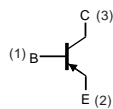

LIMITING VALUES

In accordance with the Absolute Maximum Rating System (IEC 60134).

SYMBOL	PARAMETER	CONDITIONS	MIN.	MAX.	UNIT
V _{CB0}	collector-base voltage	open emitter	-	-60	V
V _{CEO}	collector-emitter voltage	open base	-	-60	V
V _{EB0}	emitter-base voltage	open collector	-	-5	V
I _C	collector current (DC)		-	-600	mA
I _{CM}	peak collector current		-	-800	mA
I _{BM}	peak base current		-	-200	mA
P _{tot}	total power dissipation	T _{amb} ≤ 25 °C; note 1	-	350	mW
T _{stg}	storage temperature		-65	+150	°C
T _j	junction temperature		-	150	°C
T _{amb}	operating ambient temperature		-65	+150	°C

Note

1. Transistor mounted on an FR4 printed-circuit board.

RATING CHARACTERISTIC CURVES (CHT2907WPT)

THERMAL CHARACTERISTICS

SYMBOL	PARAMETER	CONDITIONS	VALUE	UNIT
$R_{th\ j-a}$	thermal resistance from junction to ambient	note 1	357	K/W

Note

1. Transistor mounted on an FR4 printed-circuit board.

CHARACTERISTICS

$T_{amb} = 25\text{ °C}$ unless otherwise specified.

SYMBOL	PARAMETER	CONDITIONS	MIN.	MAX.	UNIT
I_{CBO}	collector cut-off current	$I_E = 0; V_{CB} = -60\text{ V}$	–	-10	nA
		$I_C = 0; V_{CB} = -60\text{ V}; T_j = 125\text{ °C}$	–	-10	uA
I_{EBO}	emitter cut-off current	$I_C = 0; V_{EB} = 5\text{ V}$	–	-10	nA
h_{FE}	DC current gain	$I_C = -0.1\text{ mA}; V_{CE} = -10\text{V};$ note 1	35	–	
		$I_C = -1.0\text{ mA}; V_{CE} = -10\text{V}$	50	–	
		$I_C = -10\text{ mA}; V_{CE} = -10\text{V}$	75	–	
		$I_C = -10\text{ mA}; V_{CE} = -10\text{V}; T_a = -55\text{ °C}$	35	–	
		$I_C = -150\text{ mA}; V_{CE} = -10\text{V}$	100	300	
		$I_C = -150\text{ mA}; V_{CE} = -1.0\text{V}$	50	–	
V_{CEsat}	collector-emitter saturation voltage	$I_C = -150\text{ mA}; I_B = -15\text{ mA}$	–	-400	mV
		$I_C = -500\text{ mA}; I_B = -50\text{ mA}$	–	-1.6	V
V_{BEsat}	base-emitter saturation voltage	$I_C = -150\text{ mA}; I_B = -15\text{ mA}$	-0.6	-1.3	V
		$I_C = -500\text{ mA}; I_B = -50\text{ mA}$	–	-2.6	V
C_c	collector capacitance	$I_E = i_e = 0; V_{CB} = -5\text{ V}; f = 1\text{ MHz}$	–	8	pF
C_e	emitter capacitance	$I_C = i_c = 0; V_{BE} = -500\text{ mV}; f = 1\text{ MHz}$	–	30	pF
f_T	transition frequency	$I_C = -20\text{ mA}; V_{CE} = -20\text{ V}; f = 100\text{ MHz}$	200	–	MHz
F	noise figure	$I_C = 100\text{ }\mu\text{A}; V_{CE} = -5\text{ V}; R_S = 1\text{ k}\Omega; f = 1.0\text{ kHz}$	–	4	dB

Switching times (between 10% and 90% levels);

t_{on}	turn-on time	$I_{Con} = -150\text{ mA}; I_{Bon} = -15\text{ mA}; I_{Boff} = -15\text{ mA}$	–	35	ns
t_d	delay time		–	10	ns
t_r	rise time		–	40	ns
t_{off}	turn-off time		–	100	ns
t_s	storage time		–	80	ns
t_f	fall time		–	30	ns

Note

1. Pulse test: $t_p \leq 300\text{ }\mu\text{s}; \delta \leq 0.02.$

RATING CHARACTERISTIC CURVES (CHT2907WPT)

Total power dissipation $P_{\text{tot}} = f(T_S)$

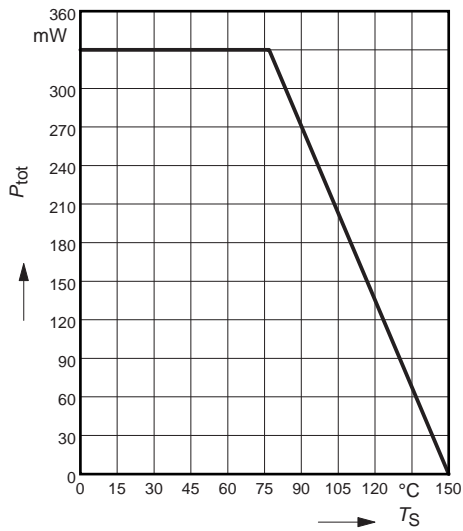

Collector-base capacitance $C_{\text{CB}} = f(V_{\text{CB}})$
 $f = 1\text{MHz}$

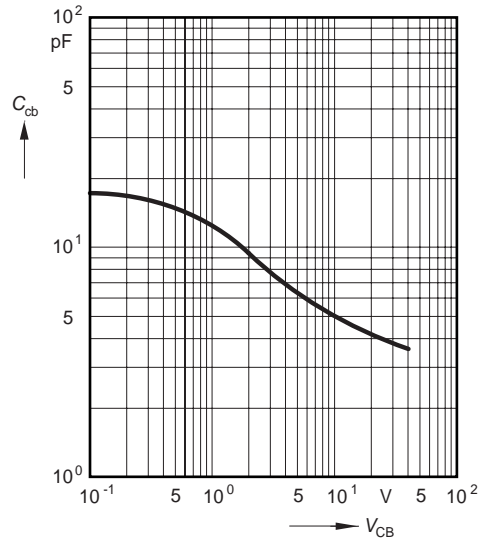

Permissible pulse load

$P_{\text{totmax}} / P_{\text{totDC}} = f(t_p)$

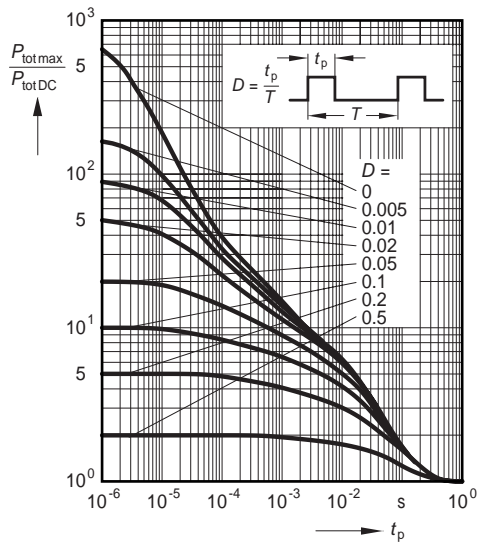

Transition frequency $f_T = f(I_C)$

$V_{\text{CE}} = 5\text{V}$

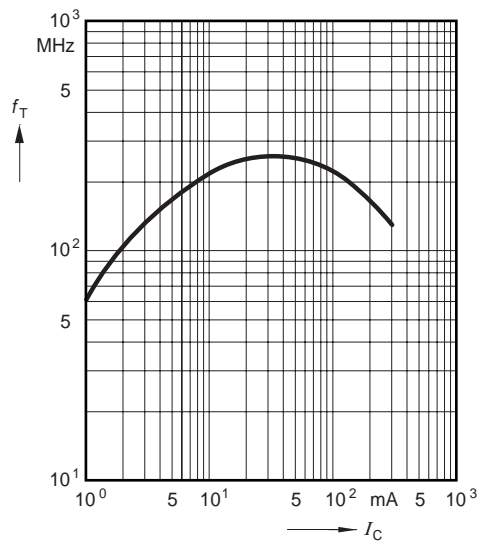

RATING CHARACTERISTIC CURVES (CHT2907WPT)

Saturation voltage $I_C = f(V_{BEsat}, V_{CEsat})$
 $h_{FE} = 10$

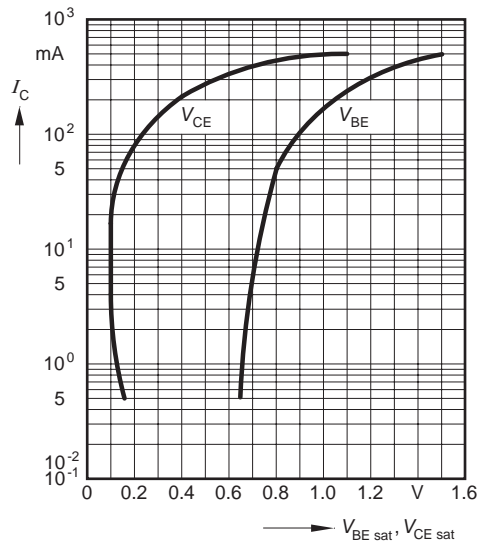

Delay time $t_d = f(I_C)$
Rise time $t_r = f(I_C)$

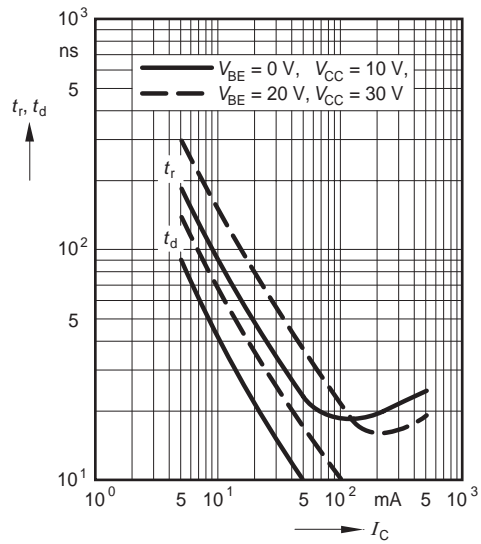

Storage time $t_{stg} = f(I_C)$

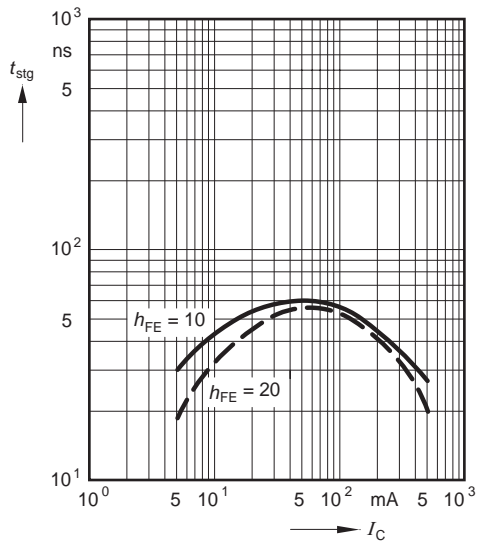

Fall time $t_f = f(I_C)$

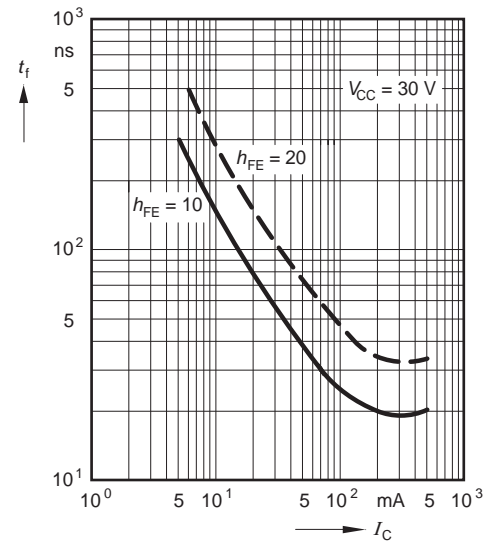

RATING CHARACTERISTIC CURVES (CHT2907WPT)

DC current gain $h_{FE} = f(I_C)$

$V_{CE} = 5V$

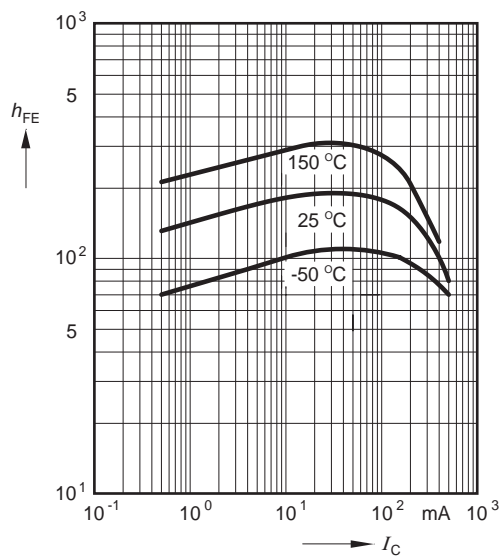

RATING CHARACTERISTIC CURVES (CHT2907WPT)

Test circuits

Delay and rise time

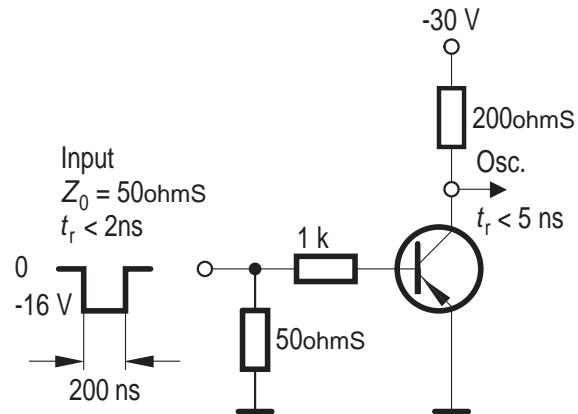

Storage and fall time

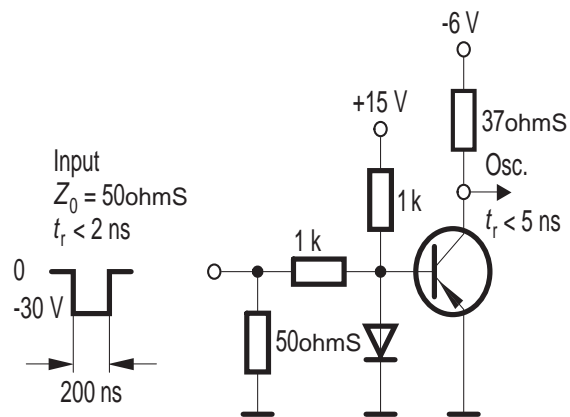

Oscilloscope: $R > 100\text{ohmS}$, $C < 12\text{pF}$, $t_r < 5\text{ns}$