

ALM-38140

50MHz – 4GHz PIN Diode Variable Attenuator Module

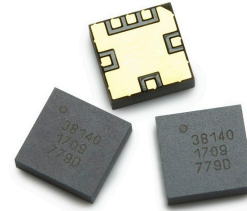

Data Sheet



Description

Avago Technologies' ALM-38140 is a fully matched wideband variable attenuator module with high linearity performance and high dynamic range. The high dynamic range and low phase shift can be achieved with only one external inductor place between Linput and Loutput.

ALM-38140 is a fully integrated solution using Avago Technologies' low distortion silicon PIN diodes housed in a miniature 3.8 x 3.8 x 1.0 mm³ MCOB (Multiple-Chips-On-Board) package.

This variable attenuator module is easily operated with a constant voltage, $V_{supply} = 2.7V$ and a control voltage, $V_{control} = 1 - 5V$. No external biasing components needed.

ALM-38140 is ideal for gain control in RF amplifier circuits.

Package Marking

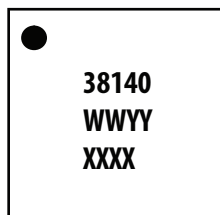

Top View

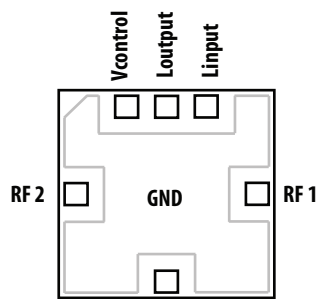

Bottom View

Note:

Package marking provides orientation and identification

"38140" = Device Part Number

"WWYY" = Work week and year of manufacture

"XXXX" = Last 4 digit of assembly lot number

* RF1 and RF2 can be used either as RF input or RF output as they are symmetrical.

Features

- Fully integrated module
- High dynamic range
- Excellent Input IP3 performance
- High Input P1dB compression
- Low phase shift performance
- Tape-and-Reel packaging option available

Specifications

Typical Performance at 1.9GHz

- Attenuation : 39dB
- Insertion Loss : 3.2dB
- Input IP3 : 50dBm
- Input P1dB : > 30dBm

Applications

- Broadband system applications; such as CATV, WCDMA, VSAT, WIMAX, Cellular base station.
- General purpose voltage controlled attenuator for low current applications.
- Temperature compensation circuitry
- Automatic Gain Control



Attention: Observe precautions for handling electrostatic sensitive devices.

ESD Machine Model = 300 V

ESD Human Body Model = 900 V

Refer to Avago Application Note A004R:

Electrostatic Discharge, Damage and Control.

ALM-80210 Absolute Maximum Rating ^[1] T_A = 25°C

Symbol	Parameter	Unit	Absolute Maximum
I _{supply, max}	Supply Current	mA	18.0
I _{control, max}	Control Current	mA	33.4
P _{in, max}	RF Input Power	dBm	27dBm CW, 36dBm with 12.5% duty cycle
P _{diss}	Total Power Dissipation	W	0.3
T _j	Junction Temperature	°C	150
T _{stg}	Storage Temperature	°C	-60 to 150

Thermal Resistance ^[2] θ_{jc} = 106.3°C/W
(V_c = 1V, V_{supply} = 2.7V, T_c = 85°C)

Notes:

1. Operation in excess of any one of these limits may result in permanent damage to the device.
2. Thermal resistance is measured from junction to case using Infra-Red method.

Electrical Specifications, V_{supply} = 2.7V, T_A = 25°C, Z₀ = 50Ω

Symbol	Parameter and Test Condition	Frequency (MHz)	Unit	Min	Typ	Max
I _{supply}	Supply Current drain (V _{control} = 1V)		mA	–	2.5	–
I _{control}	Control Current drain (V _{control} = 5V)		mA	–	20.5	–
S21	Maximum Attenuation (V _{control} = 1V)	900	dB	–	42.0	–
S21	Maximum Attenuation (V _{control} = 1V)	1900	dB	36.0	39.0	–
S21	Insertion Loss (V _{control} = 5V)	900	dB	–	2.8	–
S21	Insertion Loss (V _{control} = 5V)	1900	dB	–	3.2	3.7
	Dynamic Range	900	dB	–	38	–
	Dynamic Range	1900	dB	33	36.5	–
IRL	Input Return Loss (V _{control} = 5V)	1900	dB	10	14.5	–
ORL	Output Return Loss (V _{control} = 5V)	1900	dB	10	13.5	–
IIP3 ^[5]	Input Third Order Intercept Point	900	dBm	–	50	–
IIP3 ^[5]	Input Third Order Intercept Point	1900	dBm	–	50	–
IP1dB ^[6]	Input Power at P1dB Compression (V _{control} = 5V)	900	dBm	–	32	–
IP1dB ^[6]	Input Power at P1dB Compression (V _{control} = 5V)	1900	dBm	–	33	–
	Phase Shift (V _{control} = 1V)	1900	degrees	–	10.5	–

Notes:

4. Data above is obtained using demo board shown in Figure 32 and 33.
5. 2-tone IIP3 test condition: F_{RF1}, F_{RF2} = 1.1MHz separation, Input power = 22dBm
6. IP1dB measured with 12.5% duty cycle.
7. The performance above obtained with phase compensation inductor value based on the table 1 below.
8. Use proper biasing, heat sink and de-rating to ensure maximum channel temperature is not exceeded. See absolute maximum ratings and application note (if applicable) for more details.

ALM-38140 Typical Broadband S-Parameters

(Vsupply = 2.7V, Vctrl = 1V, Tc = 25°C, matched 50Ω)

Freq GHz	S11			S21			S12			S22		
	Mag.	dB.	Ang.	Mag.	dB.	Ang.	Mag.	dB.	Ang.	Mag.	dB.	Ang.
0.05	0.14	-17.21	-175.1	0.01	-43.21	43.6	0.01	-43.10	43.5	0.13	-17.64	-173.8
0.1	0.14	-17.23	176.3	0.01	-41.98	19.5	0.01	-42.00	19.5	0.13	-17.68	177.8
0.2	0.14	-17.32	165.5	0.01	-41.46	7.1	0.01	-41.54	7.7	0.13	-17.75	167.6
0.3	0.13	-17.50	155.6	0.01	-41.12	1.3	0.01	-41.13	1.2	0.13	-17.85	159.5
0.4	0.13	-17.62	147.0	0.01	-40.73	-3.6	0.01	-40.74	-3.6	0.13	-18.03	152.3
0.5	0.13	-17.81	139.2	0.01	-40.38	-8.1	0.01	-40.40	-8.1	0.12	-18.30	145.8
0.6	0.12	-18.06	131.5	0.01	-40.03	-12.4	0.01	-39.97	-12.4	0.12	-18.59	139.2
0.7	0.12	-18.35	123.2	0.01	-39.56	-16.4	0.01	-39.62	-16.6	0.11	-18.88	132.4
0.8	0.12	-18.55	115.4	0.01	-39.19	-21.2	0.01	-39.19	-20.9	0.11	-19.18	125.8
0.9	0.11	-18.88	108.4	0.01	-38.68	-25.3	0.01	-38.68	-25.3	0.11	-19.51	119.5
1	0.11	-19.38	100.6	0.01	-38.13	-30.4	0.01	-38.13	-30.4	0.10	-19.88	113.6
1.1	0.10	-19.78	92.2	0.01	-37.61	-35.7	0.01	-37.59	-35.5	0.10	-20.30	108.2
1.2	0.10	-20.11	85.2	0.01	-37.07	-41.1	0.01	-37.04	-41.3	0.09	-20.84	103.5
1.3	0.09	-20.71	79.3	0.01	-36.49	-47.3	0.01	-36.50	-47.0	0.08	-21.52	99.0
1.4	0.08	-21.61	72.7	0.02	-35.98	-53.1	0.02	-35.96	-53.2	0.08	-22.27	93.8
1.5	0.08	-22.49	64.6	0.02	-35.40	-59.7	0.02	-35.40	-59.6	0.07	-22.87	88.5
1.6	0.07	-23.16	57.3	0.02	-34.90	-66.0	0.02	-34.93	-66.2	0.07	-23.24	85.0
1.7	0.06	-23.92	53.0	0.02	-34.35	-73.0	0.02	-34.38	-72.8	0.07	-23.64	85.0
1.8	0.05	-25.27	50.7	0.02	-33.85	-80.0	0.02	-33.86	-79.8	0.06	-24.35	86.7
1.9	0.04	-27.06	47.5	0.02	-33.36	-86.9	0.02	-33.35	-87.0	0.05	-25.24	87.2
2	0.04	-28.95	43.5	0.02	-32.86	-94.2	0.02	-32.90	-94.2	0.05	-25.74	85.4
2.1	0.03	-30.32	42.8	0.02	-32.45	-101.1	0.02	-32.44	-101.0	0.05	-25.50	84.1
2.2	0.03	-31.50	52.5	0.03	-31.86	-108.7	0.03	-31.86	-108.7	0.06	-24.85	85.9
2.3	0.02	-32.14	72.7	0.03	-31.44	-116.5	0.03	-31.41	-116.4	0.06	-24.16	88.5
2.4	0.03	-31.61	93.4	0.03	-30.97	-124.2	0.03	-30.96	-124.0	0.07	-23.60	89.0
2.5	0.03	-30.43	102.9	0.03	-30.54	-131.6	0.03	-30.52	-131.6	0.07	-22.98	86.7
2.6	0.04	-28.44	101.9	0.03	-30.07	-139.7	0.03	-30.05	-139.7	0.08	-22.16	82.6
2.7	0.05	-26.30	98.6	0.03	-29.60	-146.4	0.03	-29.61	-146.5	0.09	-21.31	78.2
2.8	0.06	-24.35	96.5	0.04	-29.08	-155.1	0.04	-29.07	-155.0	0.10	-20.38	72.5
2.9	0.07	-23.06	92.8	0.04	-28.63	-163.2	0.04	-28.63	-163.1	0.11	-19.48	65.1
3	0.08	-22.00	85.2	0.04	-28.18	-171.5	0.04	-28.15	-171.5	0.12	-18.49	58.1
3.5	0.13	-17.56	41.6	0.05	-25.81	146.0	0.05	-25.80	146.0	0.18	-14.88	14.6
4	0.19	-14.61	-10.1	0.07	-23.54	101.2	0.07	-23.53	101.3	0.25	-11.88	-36.3
4.5	0.25	-12.02	-66.3	0.09	-21.00	51.4	0.09	-21.00	51.4	0.35	-9.12	-89.3
5	0.35	-9.20	-125.3	0.11	-19.02	-6.1	0.11	-19.01	-6.1	0.48	-6.34	-144.1
5.5	0.48	-6.44	176.4	0.12	-18.29	-67.2	0.12	-18.31	-67.2	0.62	-4.13	159.5
6	0.61	-4.35	120.7	0.11	-19.03	-126.7	0.11	-19.03	-126.8	0.72	-2.84	104.4

Notes:

9. S-parameter is measured with reference plane at SMA end launch using demo board shown in Figure 33.
10. Demo board 50Ω transmission line is CPWG with W = 23 mils, G = 18.5 mils, L = 383.7 mils, 10 mils Rogers RO4350, 0.5oz Cu.
11. Demo board SMA end launch is Johnson 142-0701-851.
12. The above performance is with board loss removed.

ALM-38140 Typical Broadband S-Parameters

(Vsupply = 2.7V, Vctrl = 5V, Tc = 25°C, matched 50Ω)

Freq GHz	S11			S21			S12			S22		
	Mag.	dB.	Ang.	Mag.	dB.	Ang.	Mag.	dB	Ang.	Mag.	dB.	Ang.
0.05	0.04	-28.48	103.9	0.74	-2.64	0.3	0.74	-2.62	0.2	0.03	-29.15	102.3
0.1	0.01	-36.56	153.6	0.73	-2.67	-7.8	0.73	-2.68	-7.8	0.01	-36.95	158.3
0.2	0.02	-33.27	-144.2	0.73	-2.69	-19.2	0.73	-2.69	-19.2	0.02	-33.01	-141.8
0.3	0.04	-28.98	-134.9	0.73	-2.72	-29.6	0.73	-2.72	-29.7	0.04	-28.32	-133.0
0.4	0.05	-25.79	-138.3	0.73	-2.73	-39.9	0.73	-2.73	-39.9	0.06	-25.01	-135.2
0.5	0.07	-23.43	-144.4	0.73	-2.74	-50.0	0.73	-2.76	-50.0	0.07	-22.65	-140.7
0.6	0.08	-21.61	-152.2	0.73	-2.77	-60.0	0.73	-2.76	-60.0	0.09	-21.00	-147.6
0.7	0.10	-20.34	-160.9	0.73	-2.79	-70.0	0.72	-2.79	-70.0	0.10	-19.60	-155.1
0.8	0.11	-19.11	-170.0	0.72	-2.83	-80.0	0.72	-2.82	-80.0	0.12	-18.40	-163.7
0.9	0.12	-18.09	-178.7	0.72	-2.84	-90.0	0.72	-2.84	-90.0	0.13	-17.41	-172.9
1	0.14	-17.34	172.5	0.72	-2.87	-99.8	0.72	-2.87	-99.9	0.15	-16.64	177.7
1.1	0.15	-16.70	162.8	0.72	-2.91	-109.8	0.72	-2.91	-109.8	0.16	-15.92	168.9
1.2	0.16	-16.03	152.5	0.71	-2.94	-119.6	0.71	-2.94	-119.7	0.17	-15.25	160.4
1.3	0.17	-15.42	143.4	0.71	-2.97	-129.5	0.71	-2.97	-129.5	0.18	-14.69	151.5
1.4	0.18	-15.06	134.9	0.71	-3.01	-139.4	0.71	-3.00	-139.4	0.19	-14.32	142.5
1.5	0.18	-14.82	126.0	0.71	-3.03	-149.2	0.70	-3.04	-149.2	0.20	-14.03	133.0
1.6	0.19	-14.43	116.3	0.70	-3.07	-159.1	0.70	-3.05	-159.1	0.21	-13.63	123.6
1.7	0.20	-14.02	106.8	0.70	-3.11	-168.9	0.70	-3.11	-168.9	0.22	-13.21	115.0
1.8	0.21	-13.76	98.1	0.70	-3.15	-178.7	0.70	-3.15	-178.7	0.22	-12.96	106.6
1.9	0.21	-13.72	89.7	0.69	-3.17	171.5	0.69	-3.17	171.5	0.23	-12.93	97.7
2	0.21	-13.70	80.8	0.69	-3.19	161.6	0.69	-3.19	161.5	0.23	-12.87	88.4
2.1	0.21	-13.56	71.4	0.69	-3.23	151.6	0.69	-3.24	151.7	0.23	-12.66	79.1
2.2	0.21	-13.38	62.5	0.69	-3.28	141.8	0.69	-3.27	141.8	0.24	-12.43	70.3
2.3	0.21	-13.36	54.1	0.68	-3.29	131.9	0.68	-3.32	131.9	0.24	-12.38	61.8
2.4	0.21	-13.53	45.7	0.68	-3.33	122.1	0.68	-3.34	122.1	0.24	-12.48	53.2
2.5	0.21	-13.67	36.3	0.68	-3.36	112.1	0.68	-3.36	112.1	0.24	-12.48	44.4
2.6	0.21	-13.71	27.0	0.68	-3.40	102.2	0.67	-3.42	102.2	0.24	-12.43	35.4
2.7	0.21	-13.68	18.4	0.67	-3.43	92.2	0.67	-3.44	92.2	0.24	-12.41	26.3
2.8	0.20	-13.79	9.8	0.67	-3.47	82.2	0.67	-3.47	82.2	0.24	-12.40	17.2
2.9	0.20	-13.98	0.3	0.67	-3.53	72.1	0.67	-3.53	72.2	0.24	-12.34	8.3
3	0.20	-14.04	-9.9	0.66	-3.59	62.1	0.66	-3.59	62.1	0.24	-12.24	-0.2
3.5	0.19	-14.42	-57.0	0.64	-3.89	11.1	0.64	-3.89	11.0	0.26	-11.64	-45.1
4	0.18	-14.77	-104.2	0.61	-4.28	-41.3	0.61	-4.28	-41.3	0.29	-10.79	-90.3
4.5	0.17	-15.15	-148.6	0.57	-4.82	-94.7	0.57	-4.82	-94.7	0.32	-9.91	-135.4
5	0.18	-14.73	175.9	0.53	-5.45	-150.7	0.53	-5.44	-150.6	0.37	-8.62	-176.9
5.5	0.23	-12.76	151.6	0.46	-6.66	148.9	0.46	-6.67	149.0	0.46	-6.75	142.6
6	0.38	-8.42	118.0	0.35	-9.23	85.5	0.35	-9.24	85.5	0.58	-4.76	98.5

ALM-38140 Typical Broadband Performance at 25°C

(Vsupply = 2.7V, Vctrl = 1V - 5V)

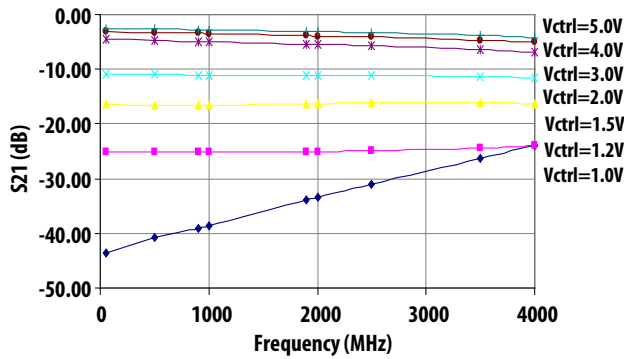

Figure 1. S21 Vs Frequency as function of Vctrl

ALM-38140 Typical Over-Temperature Broadband Performance

(Vsupply = 2.7V, Vctrl = 1V & 5V)

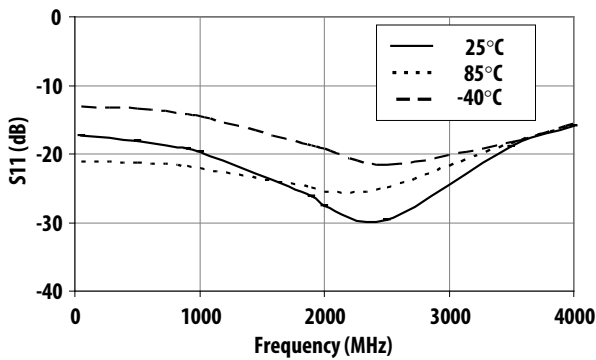

Figure 2. S11 (Return Loss) at Vctrl=1V vs Frequency vs Temperature

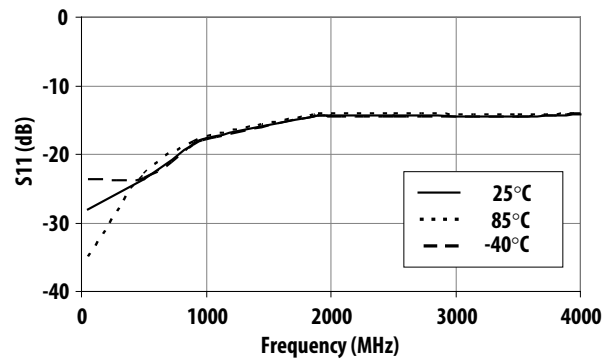

Figure 3. S11 (Return Loss) at Vctrl=5V vs Frequency vs Temperature

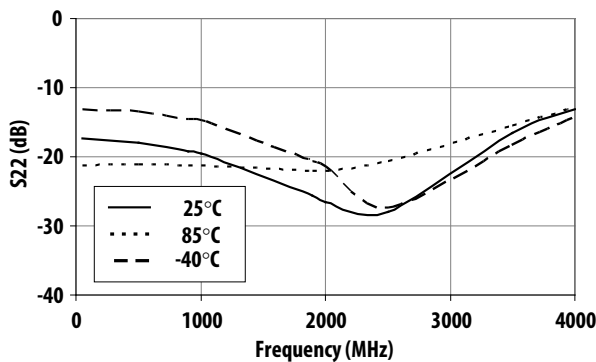

Figure 4. S22 (Return Loss) at Vctrl=1V vs Frequency vs Temperature

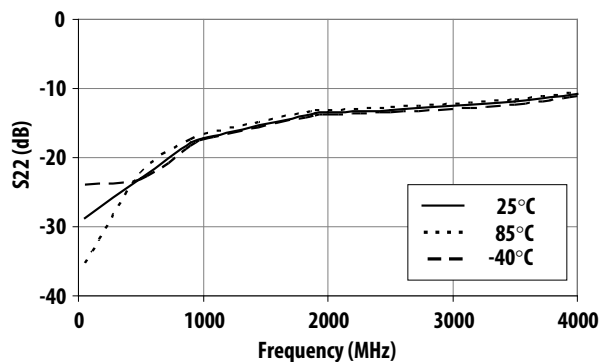

Figure 5. S22 (Return Loss) at Vctrl=5V vs Frequency vs Temperature

ALM-38140 Typical Over-Temperature Broadband Performance

(Vsupply = 2.7V, Vctrl = 1V & 5V)

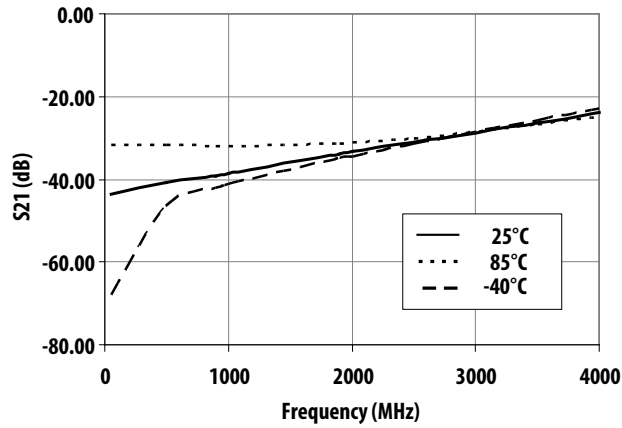

Figure 6. S21 at Vctrl=1V (Attenuation) vs Frequency vs Temperature

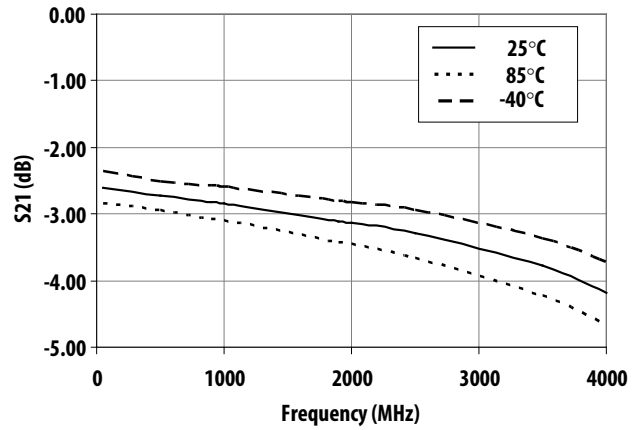

Figure 7. S21 at Vctrl=5V (Insertion Loss) vs Frequency vs Temperature

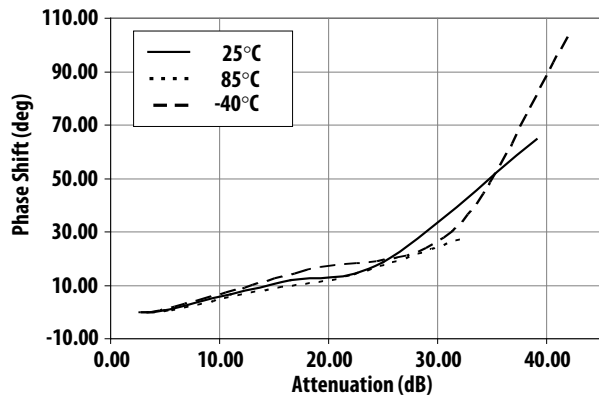

Figure 8. Phase shift vs Attenuation vs Temperature at 900MHz

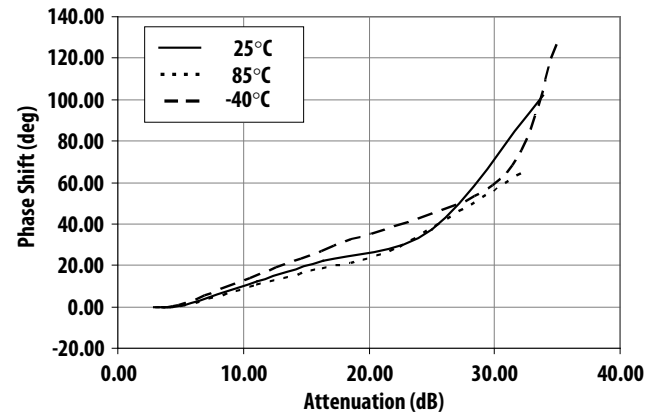

Figure 9. Phase shift vs Attenuation vs Temperature at 1900MHz

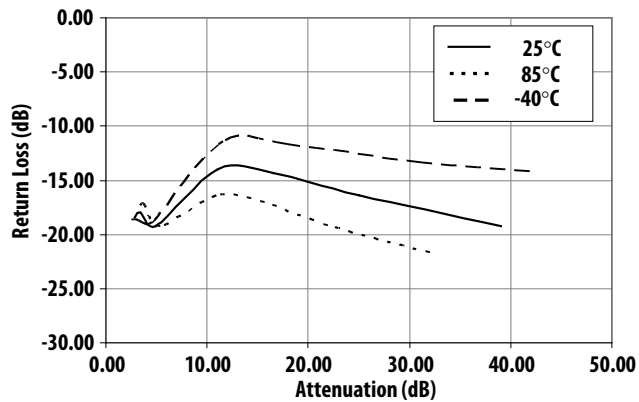

Figure 10. Return loss vs Attenuation vs Temperature at 900MHz

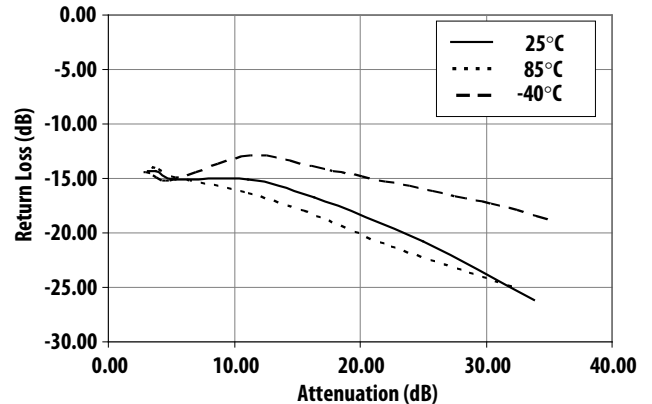

Figure 11. Return loss vs Attenuation vs Temperature at 1900MHz

ALM-38140 Typical Over-Temperature Broadband Performance

(Vsupply = 2.7V, Vctrl = 1V & 5V)

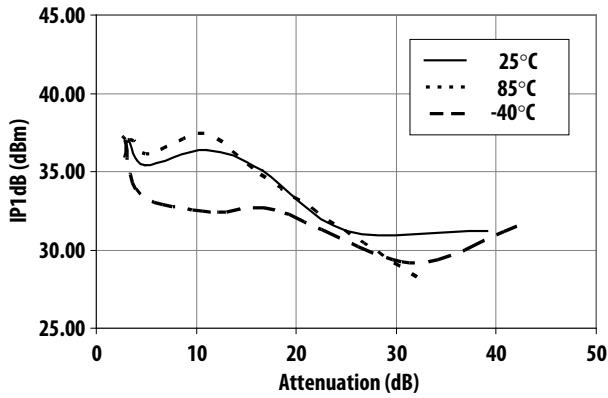

Figure 12. Input P1dB vs Attenuation vs Temperature at 900MHZ

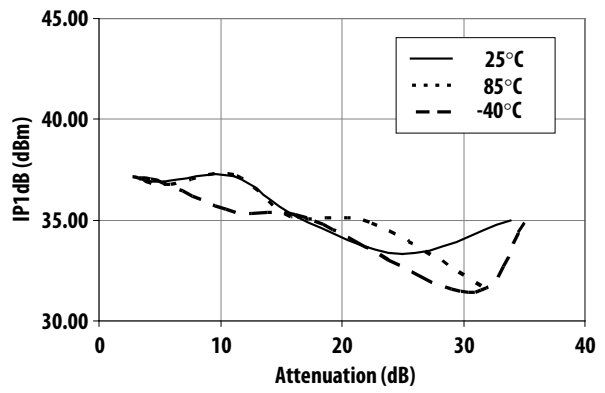

Figure 13. Input P1dB vs Attenuation vs Temperature at 1900MHZ

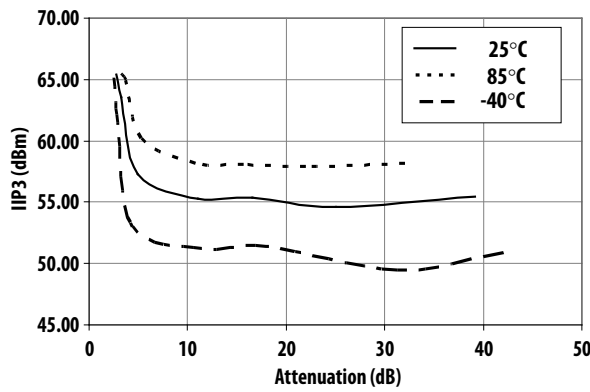

Figure 14. Input IP3 vs Attenuation vs Temperature at 900MHZ

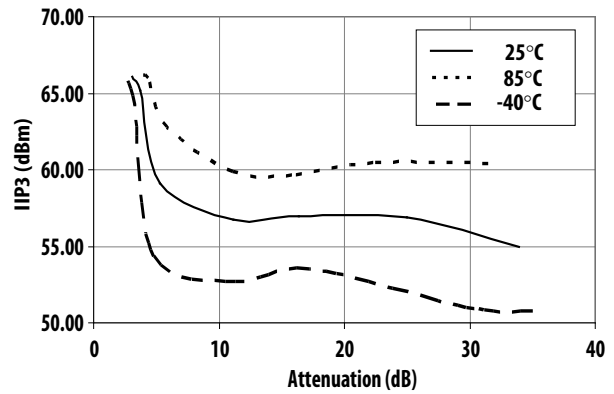

Figure 15. Input IP3 vs Attenuation vs Temperature at 1900MHZ

ALM-38140 Typical With Phase Compensation Coil Performance at 25°C

(Vsupply = 2.7V, Vctrl = 1V - 5V)

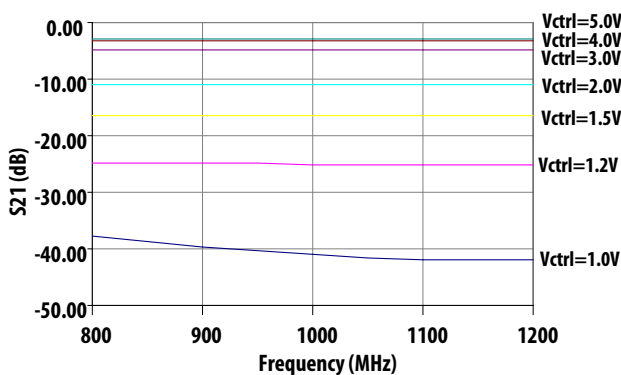

Figure 16. S21 Vs Frequency as function of Vctrl at Fc= 1GHz

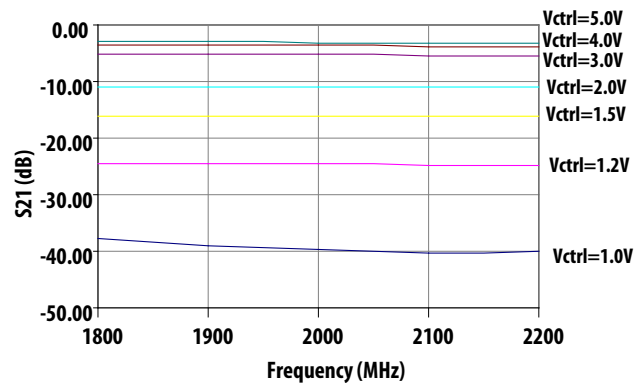

Figure 17. S21 Vs Frequency as function of Vctrl at Fc= 2GHz

ALM-38140 Typical Over-Temperature With Phase Compensation Coil Performance

(Vsupply = 2.7V, Vctrl = 1V & 5V)

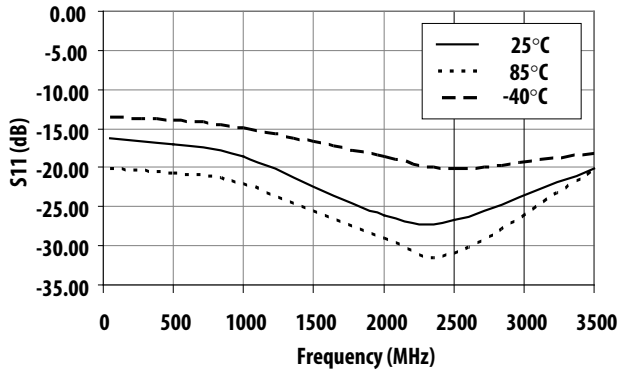

Figure 18. S11 (Return Loss) at Vctrl=1V vs Frequency vs Temperature

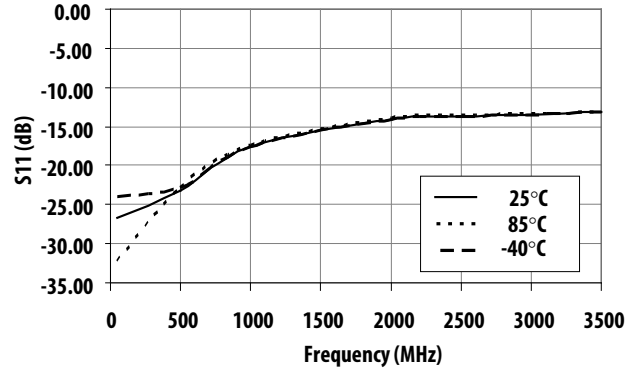

Figure 19. S11 (Return Loss) at Vctrl=5V vs Frequency vs Temperature

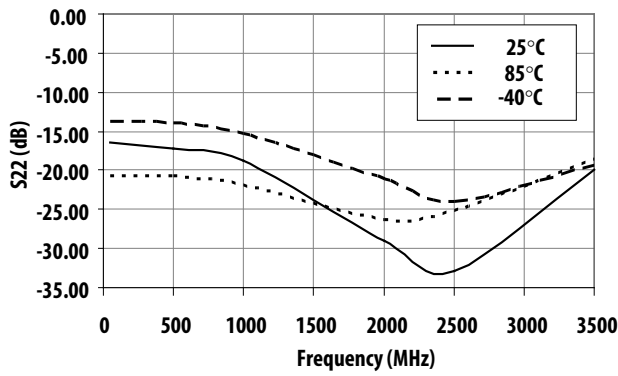

Figure 20. S22 (Return Loss) at Vctrl=1V vs Frequency vs Temperature

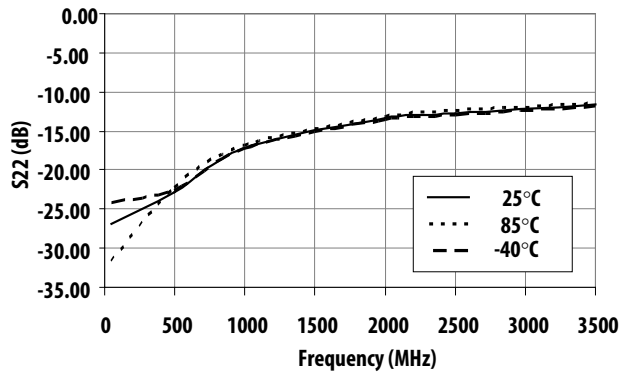

Figure 21. S22 (Return Loss) at Vctrl=5V vs Frequency vs Temperature

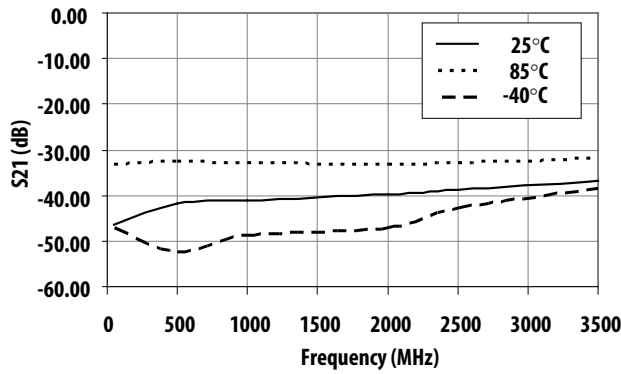

Figure 22. S21 at Vctrl=1V (Attenuation) vs Frequency vs Temperature

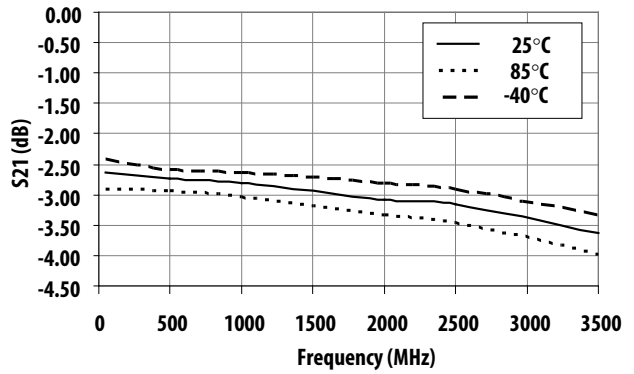

Figure 23. S21 at Vctrl=5V (Insertion Loss) vs Frequency vs Temperature

ALM-38140 Typical Over-Temperature With Phase Compensation Coil Performance

(Vsupply = 2.7V, Vctrl = 1V & 5V)

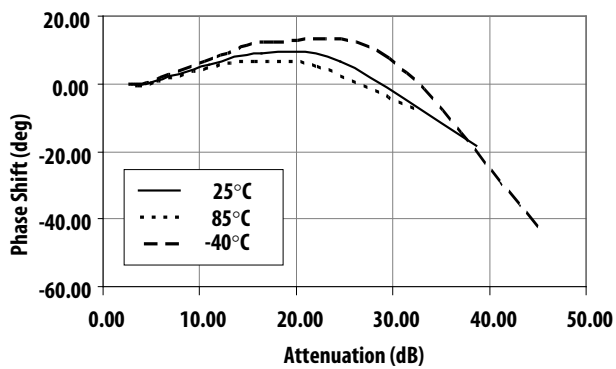

Figure 24. Phase shift vs Attenuation vs Temperature at 900MHz

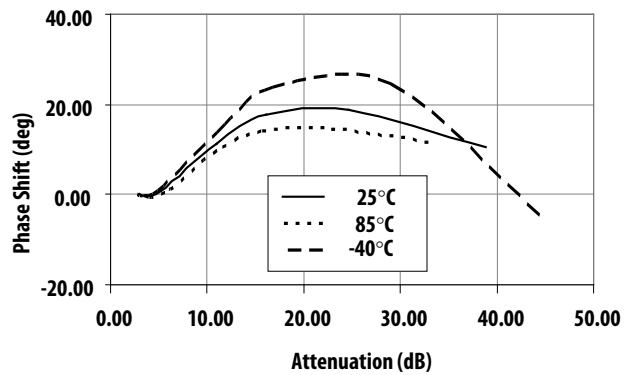

Figure 25. Phase shift vs Attenuation vs Temperature at 1900MHz

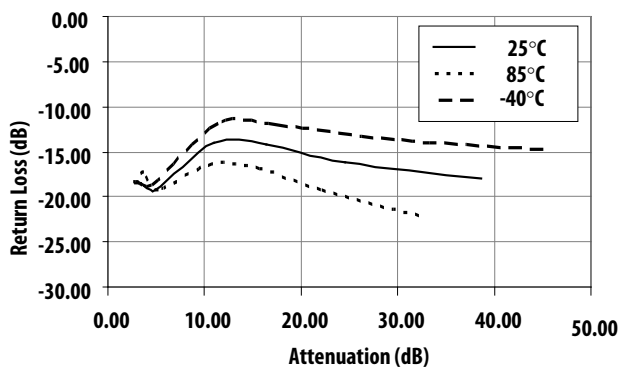

Figure 26. Return loss vs Attenuation vs Temperature at 900MHz

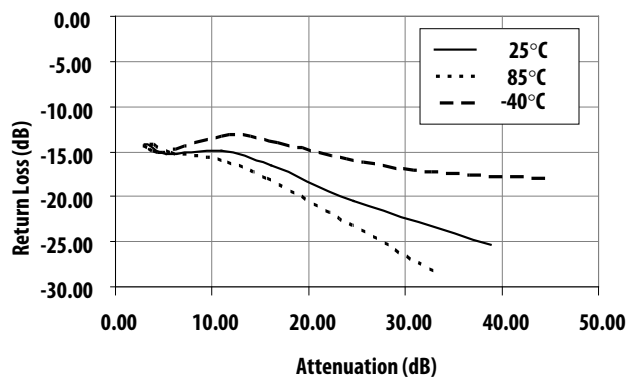

Figure 27. Return loss vs Attenuation vs Temperature at 1900MHz

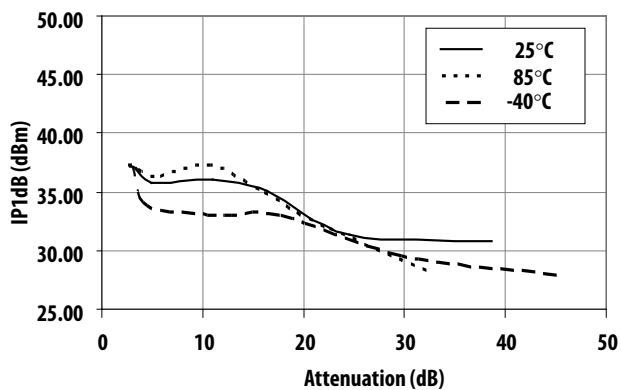

Figure 28. Input P1dB vs Attenuation vs Temperature at 900MHz

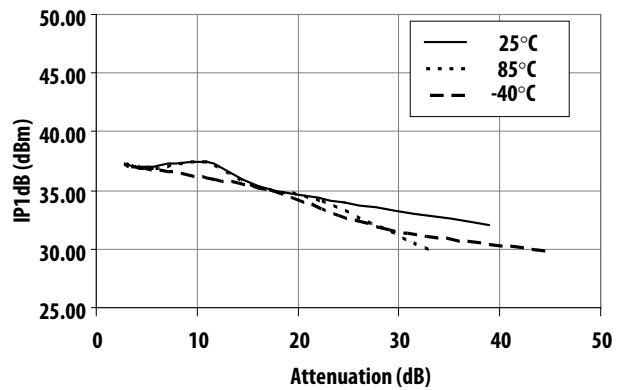

Figure 29. Input P1dB vs Attenuation vs Temperature at 1900MHz

ALM-38140 Typical Over-Temperature With Phase Compensation Coil Performance

(Vsupply = 2.7V, Vctrl = 1V & 5V)

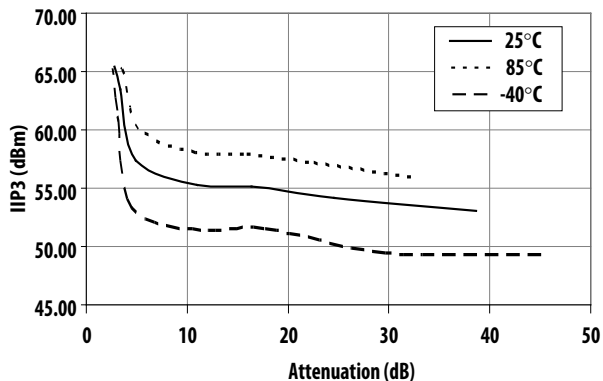

Figure 30. Input IP3 vs Attenuation vs Temperature at 900MHZ

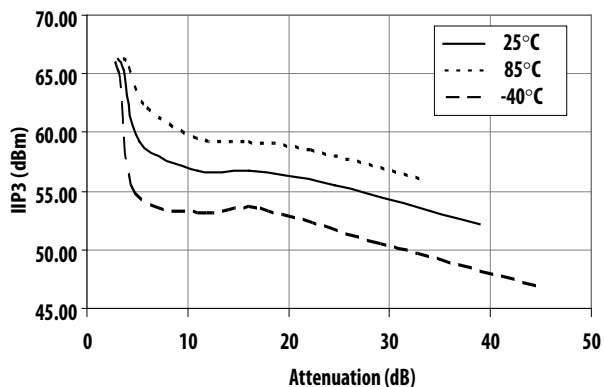

Figure 31. Input IP3 vs Attenuation vs Temperature at 1900MHZ

Application Circuit

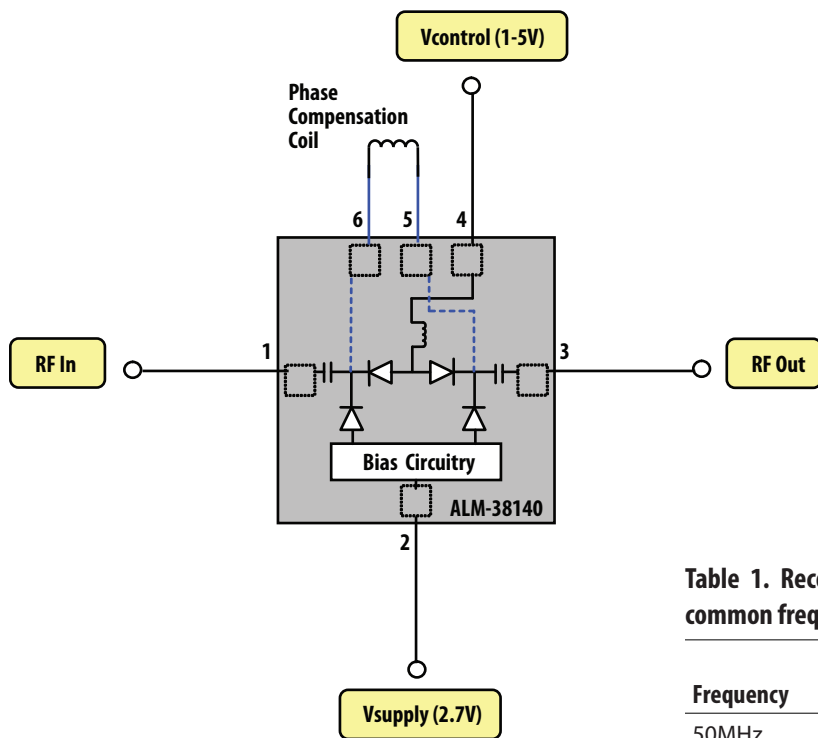

Figure 32. Simplified Schematic

The phase compensation coil connected at Pin 5 (Linput) and Pin 6 (Loutput) to further increase maximum attenuation and to improve phase shift.

Table 1. Recommended phase compensation coil values for common frequency bands

Frequency	Ltune Value	Size	Manufacturer Part No.
50MHz	3.9uH	0805	Coilcraft 0805LS-392XJLC
500MHz	220nH	0603	Toko LL2012-FR22K
1000MHz	180nH	0603	Coilcraft 0603HP-R18XJLW
2000MHz	62nH	0402	Murata LQW15AN62NG00
2500MHz	36nH	0402	Coilcraft 0402HP-36NXJLW
3500MHz	22nH	0402	Murata LQW15AN22NG00

Demo board Layout

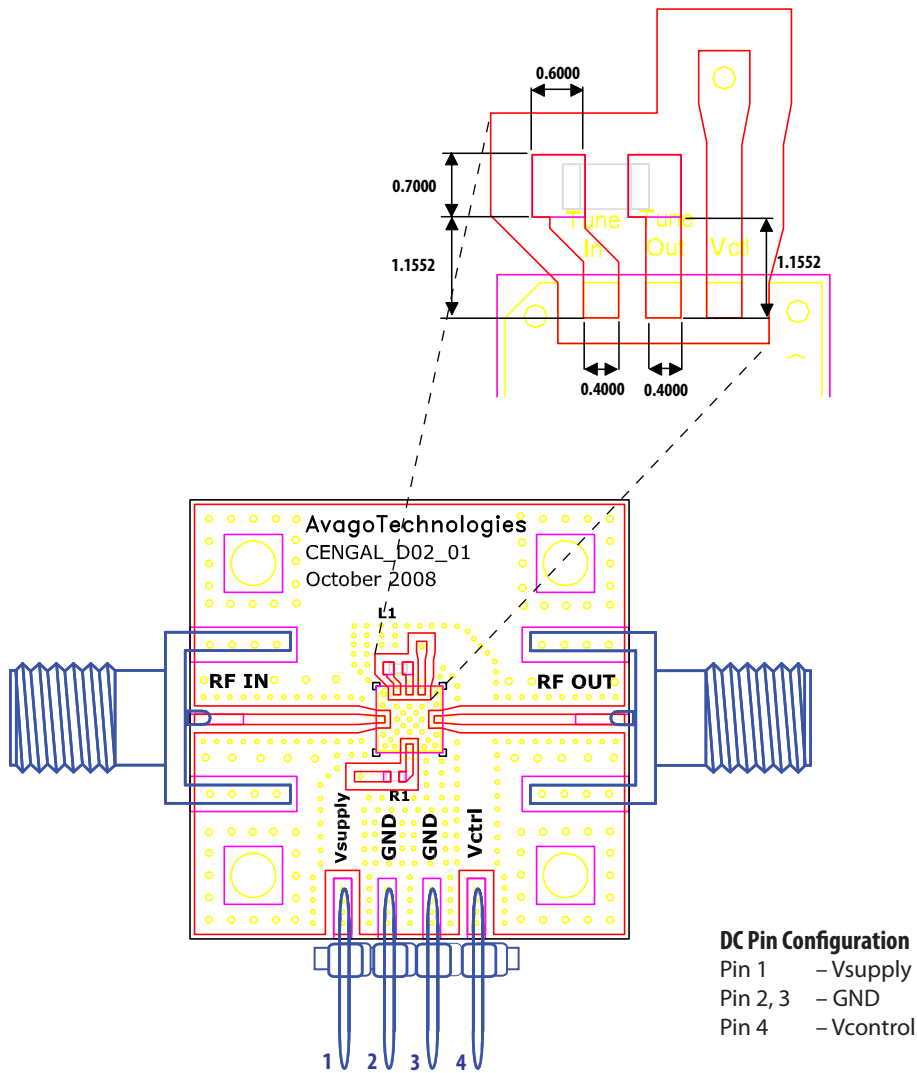

* Dimensions in mm

Figure 33. Demo board Layout

1. PCB material used is 10 mils Rogers RO4350, with FR4 backing for mechanical strength.
2. The phase compensation coil values given in Table 1 are based on the trace layout on demo board shown in Figure 33. Trace layout different from that specified in Figure 33, will require different values for the phase compensation coil.
3. Pad layout for phase compensation coil shown in Figure 33 is based on 0402 size.

Package Dimension Drawing

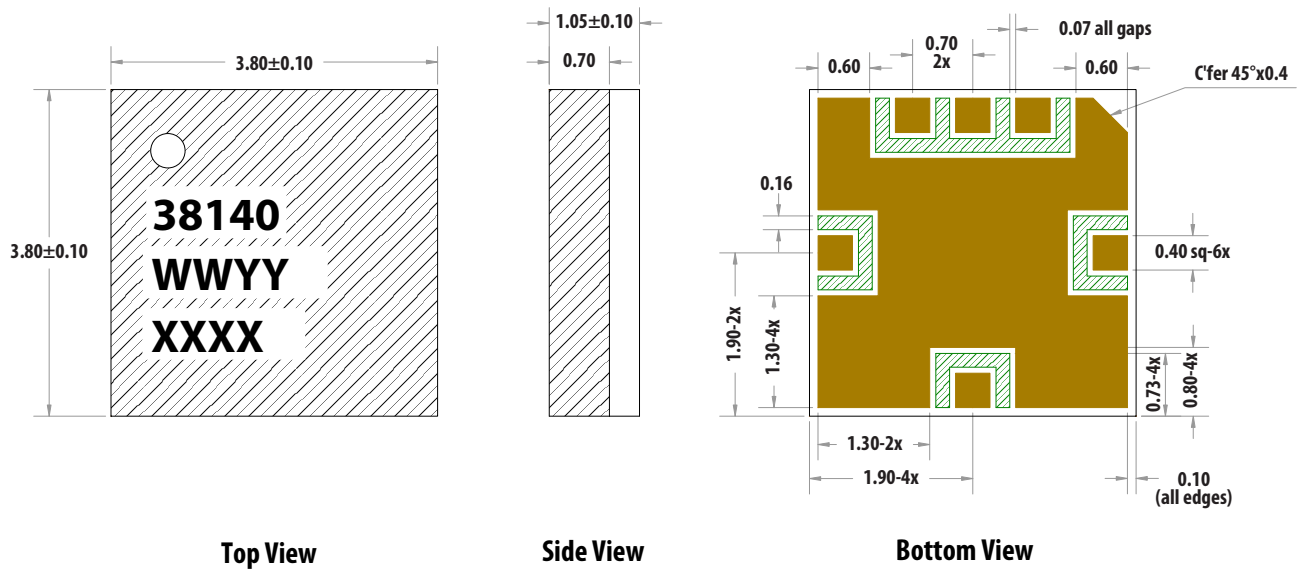

Note :

1. ALL DIMENSIONS ARE IN MILIMETERS
2. DIMENSIONS ARE INCLUSIVE OF PLATING
3. DIMENSIONS ARE EXCLUSIVE OF MOLD FLASH AND METAL BURR.
4. Y REFER TO YEAR, M REFER TO MONTH & XXXX REFER TO LAST 4 DIGIT OF LOT NUMBER

PC Board and stencil design

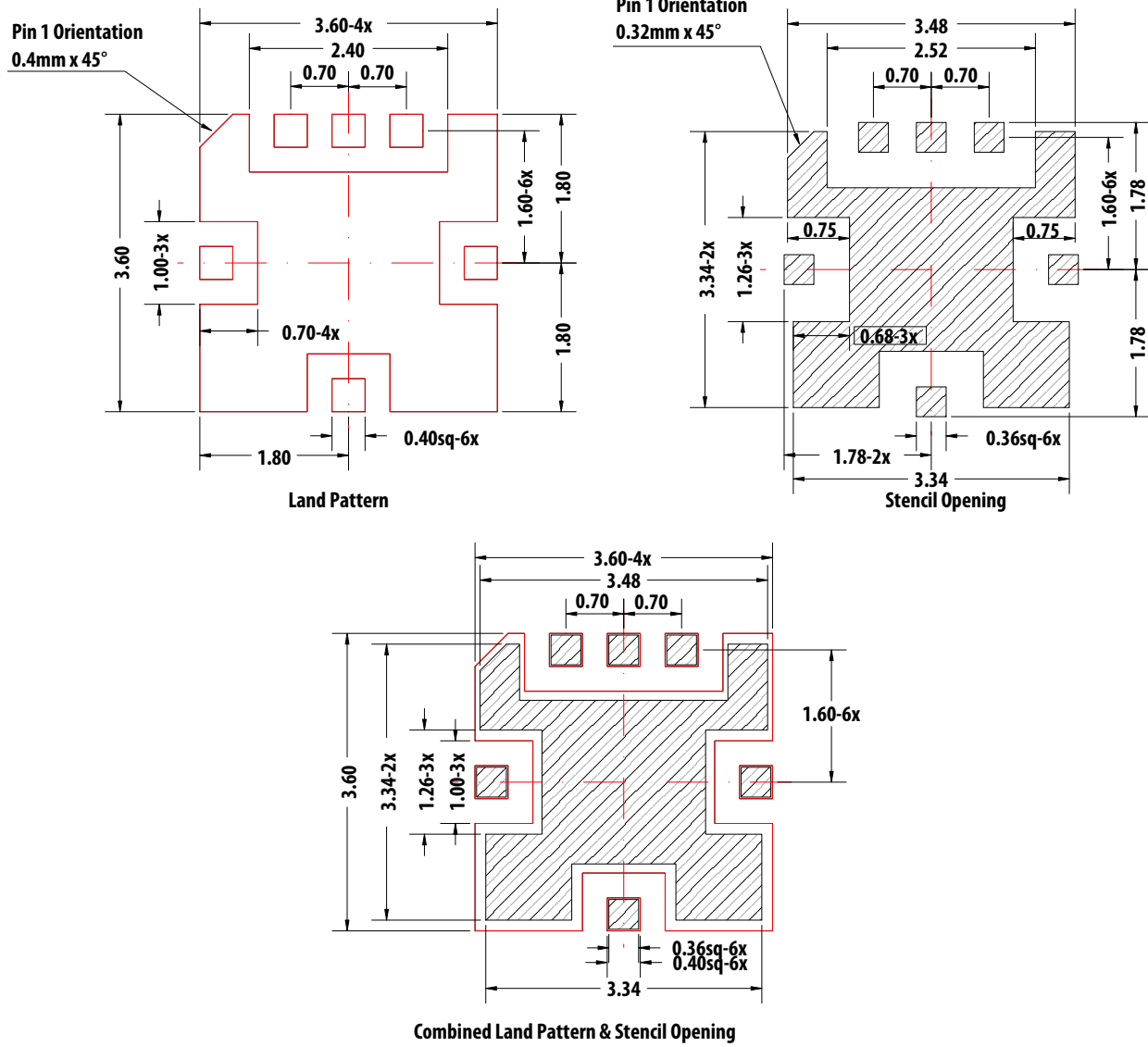

Device Orientation

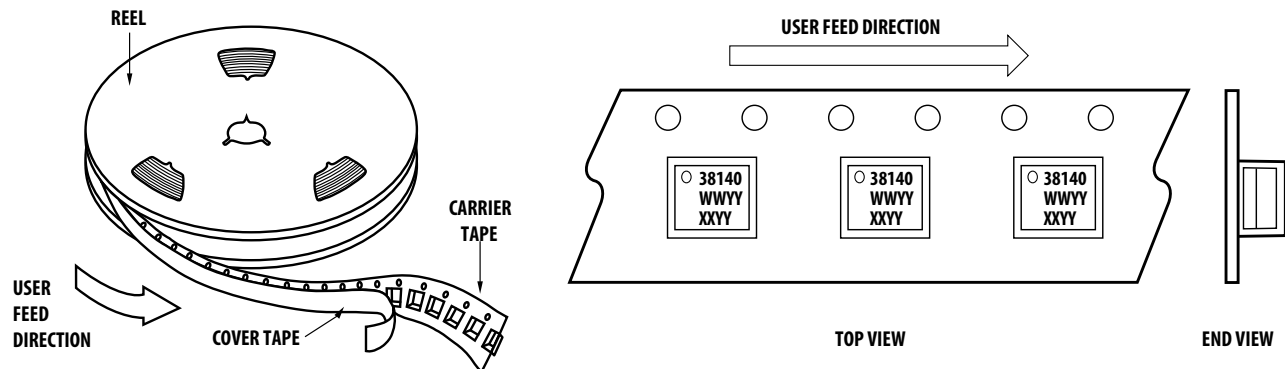

Tape Dimensions

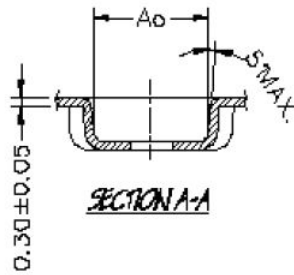
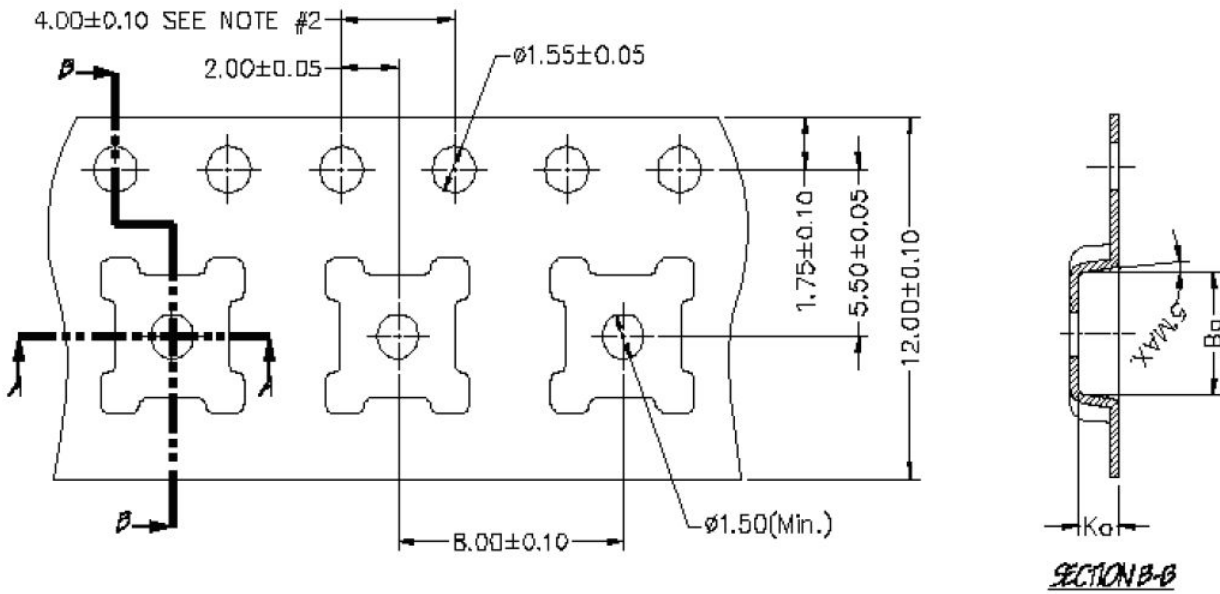

Dimension List	
Annote	Milimeter
Ao	4.10
Bo	4.10
Ko	1.45
Pitch	8.00
Width	12.00

Notes:

- Ao & Bo measured at 0.3mm above base of pocket.
- 10 pitches cumulative tol. ± 0.2 mm.

Part Number Ordering Information

Part Number	No. of Devices	Container
ALM-38140-BLKG	100	Antistatic Bag
ALM-38140-TR1G	3000	13" Reel

Reel Dimensions (13" reel)

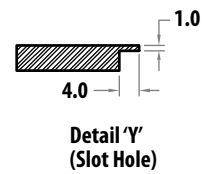
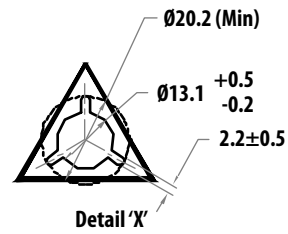
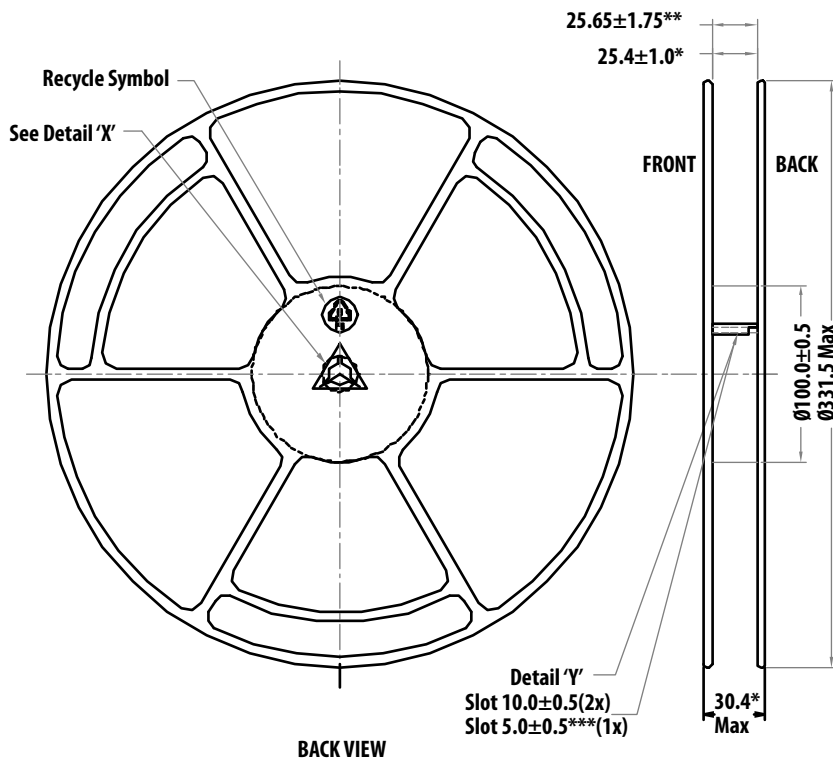
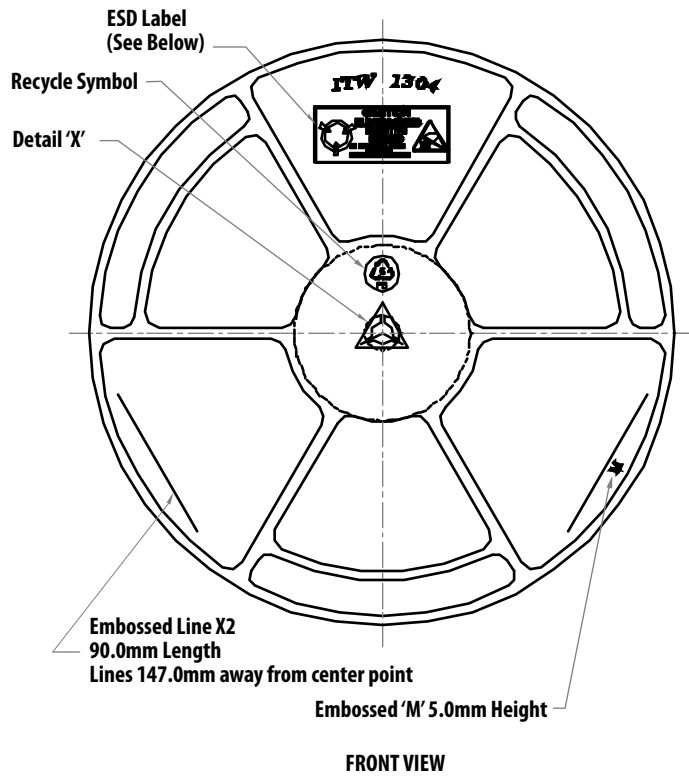

For product information and a complete list of distributors, please go to our web site: www.avagotech.com

Avago, Avago Technologies, and the A logo are trademarks of Avago Technologies in the United States and other countries. Data subject to change. Copyright © 2005-2009 Avago Technologies. All rights reserved. AV02-1987EN - July 7, 2009

