

# FM3135

## Integrated RTC/Alarm/F-RAM & Embedded Crystal



### Features

#### High Integration Device Replaces Multiple Parts

- Serial Nonvolatile Memory
- Real-time Clock (RTC) with Alarm
- Clock Output (Programmable frequency)

#### 64Kb Ferroelectric Nonvolatile RAM

- Internally Organized as 8Kx8
- Unlimited Read/Write Endurance
- 45 year Data Retention
- NoDelay™ Writes

#### Fast Two-wire Serial Interface

- Up to 1 MHz Maximum Bus Frequency
- Supports Legacy Timing for 100 kHz & 400 kHz
- RTC & F-RAM Controlled via 2-wire Interface

#### Real-time Clock/Calendar

- Embedded 32.768 kHz Crystal
- Backup Current under 1  $\mu$ A
- Seconds through Centuries in BCD format
- Tracks Leap Years through 2099
- Software Calibration
- Supports Battery or Capacitor Backup

#### Easy to Use Configurations

- Operates from 2.7 to 3.6V
- 20-pin “Green”/RoHS SOIC (-G)
- Low Operating Current
- Industrial Temperature -40°C to +85°C
- Underwriters Laboratory (UL) Recognized

### Description

The FM3135 integrates a real-time clock (RTC) and F-RAM nonvolatile memory. The 32.768kHz crystal is embedded inside the package. The device operates from 2.7 to 3.6V.

The FM3135 provides nonvolatile F-RAM which features fast write speed and unlimited endurance. This allows the memory to serve as extra RAM for the system microcontroller or conventional nonvolatile storage. This memory is truly nonvolatile rather than battery backed.

The real-time clock (RTC) provides time and date information in BCD format. It can be permanently powered from external backup voltage source, either a battery or a capacitor. The timekeeper uses a crystal integral to the package and provides a calibration mode that allows software adjustment of timekeeping accuracy.

### Pin Configuration

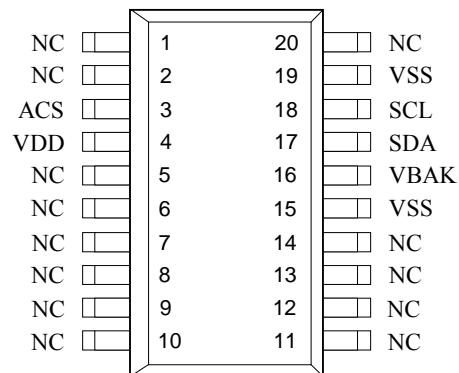

Pin Name	Function
ACS	Alarm/Calibration/SqWave
SDA	Serial Data
SCL	Serial Clock
VBAK	Battery-Backup Supply
VDD	Supply Voltage
VSS	Ground

Ordering Information	
FM3135-G	“Green”/RoHS 20-pin SOIC
FM3135-GTR	“Green”/RoHS 20-pin SOIC, Tape & Reel

This is a product that has fixed target specifications but are subject to change pending characterization results.

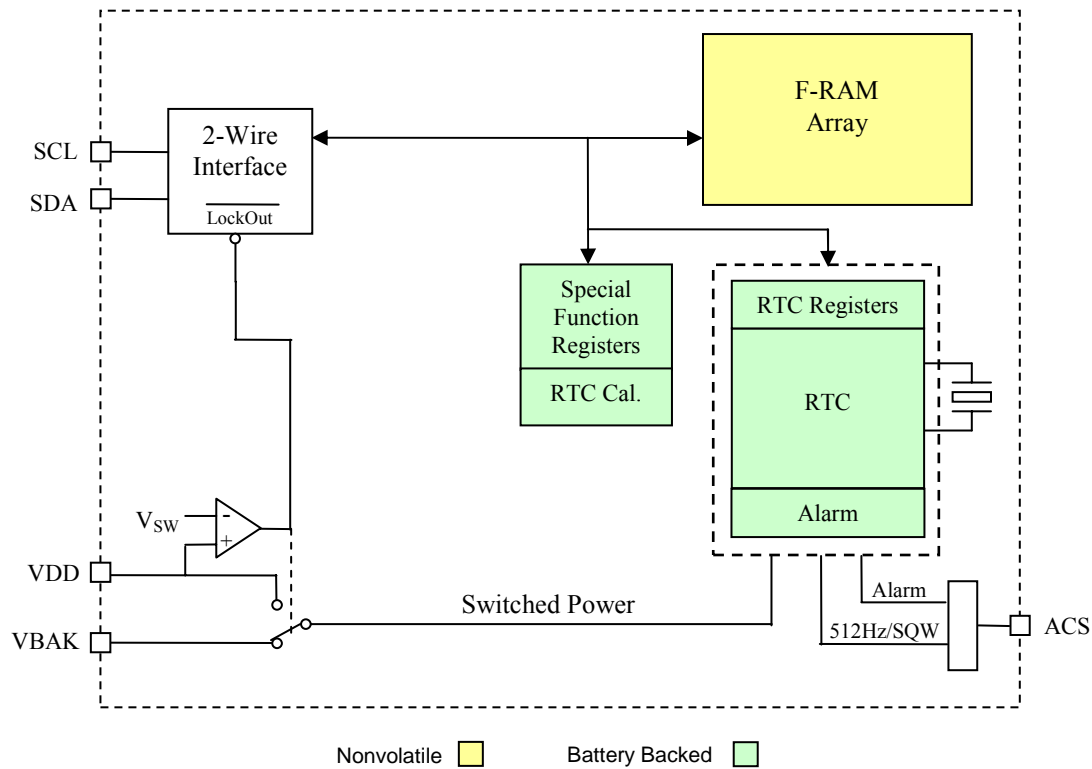

Figure 1. Block Diagram

Pin Descriptions

Pin Name	Type	Pin Description
ACS	Output	Alarm/Calibration/SquareWave: This is an open-drain output that requires an external pullup resistor. The alarm, calibration, and square wave functions all share this output. In Alarm mode, this pin acts as the active-low alarm output. In Calibration mode, a 512 Hz square-wave is driven out. In SquareWave mode, the user may select a frequency of 1, 512, 4096, or 32768 Hz to be used as a continuous output. Refer to <i>Table 3. Control Bit Settings for ACS Pin</i> to determine the bit settings for each mode.
SDA	I/O	Serial Data & Address: This is a bi-directional line for the two-wire interface. It is open-drain and is intended to be wire-OR'd with other devices on the two-wire bus. The input buffer incorporates a Schmitt trigger for noise immunity and the output driver includes slope control for falling edges. A pull-up resistor is required.
SCL	Input	Serial Clock: The serial clock line for the two-wire interface. Data is clocked out of the part on the falling edge, and data into the device on the rising edge. The SCL input also incorporates a Schmitt trigger input for noise immunity.
VBAK	Supply	Backup supply voltage: A 3V battery or a large value capacitor. If no backup supply is used, this pin should be tied to V <sub>SS</sub> . The trickle charger is UL recognized and ensures no excessive current when using a lithium battery.
VDD	Supply	Supply Voltage.
VSS	Supply	Ground

## Overview

The FM3135 device combines a serial nonvolatile RAM with a real-time clock (RTC) and alarm. These complementary but distinct functions share a common interface in a single package. Although monolithic, the product is organized as two logical devices, the F-RAM memory and the RTC/alarm. From the system perspective, they appear to be two separate devices with unique IDs on the serial bus.

The memory is organized as a stand-alone 2-wire nonvolatile memory with a standard device ID value. The real-time clock and alarm are accessed with a separate 2-wire device ID. This allows clock/calendar data to be read while maintaining the most recently used memory address. The clock and alarm are controlled by 15 special function registers. The registers are maintained by the power source on the V<sub>BAK</sub> pin, allowing them to operate from battery or backup capacitor power when V<sub>DD</sub> drops below a set threshold. Each functional block is described below.

## Memory Operation

The FM3135 integrates a 64Kb F-RAM. The memory is organized in bytes, 8192 addresses of 8 bits each. The memory is based on F-RAM technology. Therefore it can be treated as RAM and is read or written at the speed of the two-wire bus with no delays for write operations. It also offers effectively unlimited write endurance unlike other nonvolatile memory technologies. The two-wire interface protocol is described further on page 12.

The memory array can be write-protected by software. Two bits (WP0, WP1) in register 0Eh control the protection setting as shown in the following table. Based on the setting, the protected addresses cannot be written and the 2-wire interface will not acknowledge any data to protected addresses. The special function registers containing these bits are described in detail below.

**Table 1. F-RAM Write-Protect**

Write-Protect Range	WP1	WP0
None	0	0
Bottom 1/4	0	1
Bottom 1/2	1	0
Full array	1	1

The WP bits are battery-backed. On a powerup without a backup source, the WP bits are cleared to a '0' state.

## Real-Time Clock Operation

The real-time clock (RTC) is a timekeeping device that can be battery or capacitor backed for permanently-powered operation. It offers a software calibration feature that allows high accuracy.

The RTC consists of an oscillator, clock divider, and a register system for user access. It divides down the 32.768 kHz time-base and provides a minimum resolution of seconds (1Hz). Static registers provide the user with read/write access to the time values. It includes registers for seconds, minutes, hours, day-of-the-week, date, months, and years. A block diagram (Figure 2) illustrates the RTC function.

The user registers are synchronized with the timekeeper core using R and W bits in register 00h described below. Changing the R bit from 0 to 1 transfers timekeeping information from the core into holding registers that can be read by the user. If a timekeeper update is pending when R is set, then the core will be updated prior to loading the user registers. The registers are frozen and will not be updated again until the R bit is cleared to '0'. R is used to read the time.

Setting the W bit to '1' locks the user registers. Clearing it to a '0' causes the values in the user registers to be loaded into the timekeeper core. W is used for writing new time values. Users should be certain not to load invalid values, such as FFh, to the timekeeping registers. Updates to the timekeeping core occur continuously except when locked. All timekeeping registers must be initialized at the first powerup or when the LB bit is set. See the description of the LB bit on page 11.

## Backup Power

The real-time clock/calendar is intended to be permanently powered. When the primary system power fails, the voltage on the V<sub>DD</sub> pin will drop. When V<sub>DD</sub> is less than V<sub>SW</sub>, the RTC will switch to the backup power supply on V<sub>BAK</sub>. The clock operates at extremely low current in order to maximize battery or capacitor life. However, an advantage of combining a clock function with F-RAM memory is that data is not lost regardless of the backup power source.

If a battery is applied without a V<sub>DD</sub> power supply, the device has been designed to ensure the I<sub>BAK</sub> current does not exceed the 1μA maximum limit.

## Trickle Charger

To facilitate capacitor backup the V<sub>BAK</sub> pin can optionally provide a trickle charge current. When the

VBC bit (register 0Eh, bit 2) is set to a '1', the  $V_{BAK}$  pin will source approximately 80  $\mu A$  until  $V_{BAK}$  reaches  $V_{DD}$ . This charges the capacitor to  $V_{DD}$  without an external diode and resistor charger. There is a Fast Charge mode which is enabled by the FC bit (register 0Eh, bit 1). In this mode the trickle charger current is set to approximately 1 mA, allowing a large backup capacitor to charge more quickly.

- In the case where no battery is used, the  $V_{BAK}$  pin should be tied to  $V_{SS}$ .

*Note: systems using lithium batteries should clear the VBC bit to 0 to prevent battery charging. The  $V_{BAK}$  circuitry includes an internal 1 K $\Omega$  series resistor as a safety element. The trickle charger is UL Recognized.*

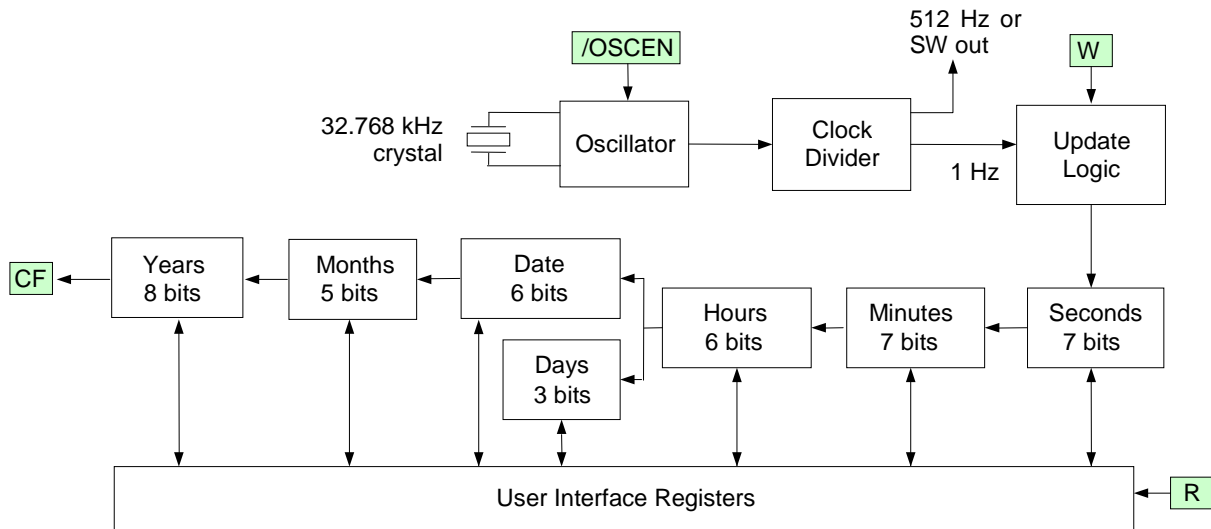

Figure 2. Real-Time Clock Core Block Diagram

**Calibration**

When the CAL bit in register 00h is set to '1', the clock enters calibration mode. In calibration mode, the ACS output pin is dedicated to the calibration function and the power fail output is temporarily unavailable. Calibration operates by applying a digital correction to the counter based on the frequency error. In this mode, the ACS pin is driven with a 512 Hz (nominal) square wave. Any measured deviation from 512 Hz translates into a timekeeping error. The user converts the measured error in ppm and writes the appropriate correction value to the calibration register. The correction factors are listed in the table below. Positive ppm errors require a negative adjustment that removes pulses. Negative ppm errors require a positive correction that adds pulses. Positive ppm adjustments have the CALS (sign) bit set to '1', whereas negative ppm adjustments have CALS = 0. After calibration, the

clock will have a maximum error of  $\pm 2.17$  ppm or  $\pm 0.09$  minutes per month at the calibrated temperature.

The calibration setting is battery-backed and must be reloaded should the backup source fail. It is accessed with bits CAL.4-0 in register 01h. This value only can be written when the CAL bit is set to a '1'. To exit the calibration mode, the user must clear the CAL bit to a '0'. When the CAL bit is '0', the ACS pin will revert to another function as defined in Table 3. Control Bit Settings for ACS Pin.

Table 2. Calibration Adjustments

Positive Calibration for slow clocks: Calibration will achieve $\pm 2.17$ PPM after calibration					
	Measured Frequency Range		Error Range (PPM)		Program Calibration Register to:
	Min	Max	Min	Max	
0	512.0000	511.9989	0	2.17	000000
1	511.9989	511.9967	2.18	6.51	100001
2	511.9967	511.9944	6.52	10.85	100010
3	511.9944	511.9922	10.86	15.19	100011
4	511.9922	511.9900	15.20	19.53	100100
5	511.9900	511.9878	19.54	23.87	100101
6	511.9878	511.9856	23.88	28.21	100110
7	511.9856	511.9833	28.22	32.55	100111
8	511.9833	511.9811	32.56	36.89	101000
9	511.9811	511.9789	36.90	41.23	101001
10	511.9789	511.9767	41.24	45.57	101010
11	511.9767	511.9744	45.58	49.91	101011
12	511.9744	511.9722	49.92	54.25	101100
13	511.9722	511.9700	54.26	58.59	101101
14	511.9700	511.9678	58.60	62.93	101110
15	511.9678	511.9656	62.94	67.27	101111
16	511.9656	511.9633	67.28	71.61	110000
17	511.9633	511.9611	71.62	75.95	110001
18	511.9611	511.9589	75.96	80.29	110010
19	511.9589	511.9567	80.30	84.63	110011
20	511.9567	511.9544	84.64	88.97	110100
21	511.9544	511.9522	88.98	93.31	110101
22	511.9522	511.9500	93.32	97.65	110110
23	511.9500	511.9478	97.66	101.99	110111
24	511.9478	511.9456	102.00	106.33	111000
25	511.9456	511.9433	106.34	110.67	111001
26	511.9433	511.9411	110.68	115.01	111010
27	511.9411	511.9389	115.02	119.35	111011
28	511.9389	511.9367	119.36	123.69	111100
29	511.9367	511.9344	123.70	128.03	111101
30	511.9344	511.9322	128.04	132.37	111110
31	511.9322	511.9300	132.38	136.71	111111

Negative Calibration for fast clocks: Calibration will achieve $\pm 2.17$ PPM after calibration					
	Measured Frequency Range		Error Range (PPM)		Program Calibration Register to:
	Min	Max	Min	Max	
0	512.0000	512.0011	0	2.17	000000
1	512.0011	512.0033	2.18	6.51	000001
2	512.0033	512.0056	6.52	10.85	000010
3	512.0056	512.0078	10.86	15.19	000011
4	512.0078	512.0100	15.20	19.53	000100
5	512.0100	512.0122	19.54	23.87	000101
6	512.0122	512.0144	23.88	28.21	000110
7	512.0144	512.0167	28.22	32.55	000111
8	512.0167	512.0189	32.56	36.89	001000
9	512.0189	512.0211	36.90	41.23	001001
10	512.0211	512.0233	41.24	45.57	001010
11	512.0233	512.0256	45.58	49.91	001011
12	512.0256	512.0278	49.92	54.25	001100
13	512.0278	512.0300	54.26	58.59	001101
14	512.0300	512.0322	58.60	62.93	001110
15	512.0322	512.0344	62.94	67.27	001111
16	512.0344	512.0367	67.28	71.61	010000
17	512.0367	512.0389	71.62	75.95	010001
18	512.0389	512.0411	75.96	80.29	010010
19	512.0411	512.0433	80.30	84.63	010011
20	512.0433	512.0456	84.64	88.97	010100
21	512.0456	512.0478	88.98	93.31	010101
22	512.0478	512.0500	93.32	97.65	010110
23	512.0500	512.0522	97.66	101.99	010111
24	512.0522	512.0544	102.00	106.33	011000
25	512.0544	512.0567	106.34	110.67	011001

26	512.0567	512.0589	110.68	115.01	011010
27	512.0589	512.0611	115.02	119.35	011011
28	512.0611	512.0633	119.36	123.69	011100
29	512.0633	512.0656	123.70	128.03	011101
30	512.0656	512.0678	128.04	132.37	011110
31	512.0678	512.0700	132.38	136.71	011111

**Alarm**

The alarm function compares user-programmed alarm values to the corresponding RTC time/date values. When a match occurs, an alarm event occurs. The alarm event sets an internal flag AF (register 00h, bit 6) and drives the ACS pin low, if the appropriate control bits are set in registers 00h and 0Eh. See Table 3. The alarm condition on the ACS pin and the AF bit are cleared by reading register 00h.

The alarm operates under V<sub>DD</sub> or V<sub>BAK</sub> power. If the system controller is being used to detect an alarm while the FM3135 is powered on V<sub>BAK</sub> only, the ACS pin may cause extra I<sub>BAK</sub> current when the alarm is activated. To avoid battery drain, the ACS pin can be tri-stated by reading the AF flag, located in the RTC/Alarm Control register 00h.

There are five alarm match fields. They are Month, Date, Hours, Minutes, and Seconds. Each of these fields also has a Match bit that is used to determine if the field is used in the alarm match logic. Setting the Match bit to ‘0’ indicates that the corresponding field will be used in the match process.

Depending on the Match bits, the alarm can occur as specifically as one particular second on one day of the month, or as frequently as once per second continuously. The MSB of each Alarm register is a Match bit. Examples of the Match bit settings are shown in *Table 4. Alarm Match Bit Examples*. Selecting none of the match bits (all ‘1’s) indicates that no match is required. The alarm occurs every second. Setting the match select bit for seconds to ‘0’ causes the logic to match the seconds alarm value to the current time of day. Since a match will occur for only one value per minute, the alarm occurs once per minute. Likewise setting the seconds and minutes match select bits causes an exact match of these values. Thus, an alarm will occur once per hour. Setting seconds, minutes, and hours causes a match once per day. See Table 4 for other alarm setting examples.

**Function of the ACS Pin**

The ACS pin is a multifunction pin. The alarm, calibration, and square wave functions all share this output. There are two ways a user can detect an alarm event, by reading the AF flag or by monitoring the ACS pin. An interrupt pin on the host processor may be used to detect an alarm event. The AF flag in the register 00h (bit 6) will indicate that a time/date match has occurred. When a match occurs, the AF bit will be set to ‘1’ and the ACS pin will drive low. The flag and ACS pin will remain in this state until the RTC/Alarm Control register is read which clears the AF bit.

Table 3 that shows the relationship between register control settings and the function of the ACS pin.

**Table 3. Control Bit Settings for ACS Pin**

State of Register Bit			Function of ACS pin
CAL	AEN	AL/SW	
0	1	1	/Alarm
0	X	0	Sq Wave out
1	X	X	512 Hz out
0	0	1	Hi-Z

**Cal Output/SquareWave Output**

When the RTC calibration mode is invoked by setting the CAL bit (register 00h, bit 2), the ACS output pin will be driven with a 512 Hz square wave and the alarm will continue to operate. Since most users only invoke the calibration mode during production, this should have no impact on the otherwise normal operation of the alarm.

The ACS output may also be used to drive the system with a continuous frequency. The AL/SW bit (register 0Eh, bit 7) must be a '0'. A user-selectable frequency is provided by F0 and F1 (register 0Eh, bits 5 and 6). The frequencies are 1, 512, 4096, and 32768 Hz. If a continuous frequency output is enabled by using the 512Hz or SquareWave out functions, the alarm function will not be available.

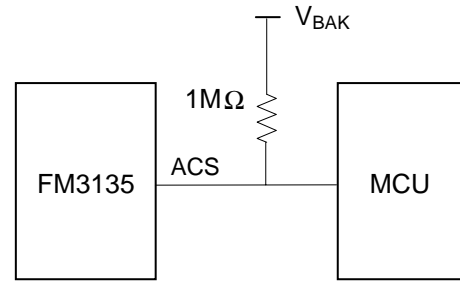

**Figure 4. ACS Pin Requires Pullup**

The ACS pin is an open-drain output that needs to be pulled up to a supply. The ACS pin and pullup resistor draws current only when the alarm is triggered.

**Table 4. Alarm Match Bit Examples**

Seconds	Minutes	Hours	Date	Months	Alarm condition
1	1	1	1	1	No match required = alarm 1/second
0	1	1	1	1	Alarm when seconds match = alarm 1/minute
0	0	1	1	1	Alarm when seconds, minutes match = alarm 1/hour
0	0	0	1	1	Alarm when seconds, minutes, hours match = alarm 1/date
0	0	0	0	1	Alarm when seconds, minutes, hours, date match = alarm 1/month

### Register Map

The RTC, alarm, and other functions are accessed via 15 special function registers mapped to a separate 2-wire device ID. The interface protocol is described below. The registers contain timekeeping data, control bits, or information flags. A description of each register follows the summary table below.

**Register Map Summary Table**

Address	D7	D6	D5	D4	D3	D2	D1	D0	Function	Range
0Eh	AL/SW	F1	F0	WP1	WP0	VBC	FC	TST	Alarm & WP Control	
0Dh	/Match	0	0	10 mo	Alarm months				Alarm Month	01-12
0Ch	/Match	0	10 date		Alarm date				Alarm Date	01-31
0Bh	/Match	0	Alarm 10 hours		Alarm hours				Alarm Hours	00-23
0Ah	/Match	Alarm 10 minutes		Alarm minutes				Alarm Minutes	00-59	
09h	/Match	Alarm 10 seconds		Alarm seconds				Alarm Seconds	00-59	
08h	10 years			years				RTC Years	00-99	
07h	0	0	0	10 mo	months				RTC Month	1-12
06h	0	0	10 date		date				RTC Date	1-31
05h	0	0	0	0	0	day			RTC Day	1-7
04h	0	0	10 hours		hours				RTC Hours	0-23
03h	0	10 minutes		minutes				RTC Minutes	0-59	
02h	0	10 seconds		seconds				RTC Seconds	0-59	
01h	/OSCEN	-	CALS	CAL4	CAL3	CAL2	CAL1	CAL0	CAL/Control	
00h	LB	AF	CF	POR	AEN	CAL	W	R	RTC/Alarm Control	

Note: When the device is first powered up, all registers should be treated as unknown and must be written. Otherwise, unpredictable behavior may result.



Register Description

Address Description

<b>0Eh</b>	<b>Alarm &amp; WP Control</b>							
	<b>D7</b>	<b>D6</b>	<b>D5</b>	<b>D4</b>	<b>D3</b>	<b>D2</b>	<b>D1</b>	<b>D0</b>
	AL/SW	F1	F0	WP1	WP0	VBC	FC	TST
AL/SW	Alarm/Square Wave Select: When set to 1, the alarm controls the ACS pin as well as the AF flag. When set to 0, the selected Square Wave Freq will be driven on the ACS pin, and an alarm match only sets the AF flag. Battery-backed, read/write.							
F(1:0)	Square Wave Freq Select: These bits select the frequency on the ACS pin when the CAL and AL/SW bits are both 0. Battery-backed.							
	<u>Setting</u>		<u>F(1:0)</u>		<u>Setting</u>		<u>F(1:0)</u>	
	1 Hz		00 (default)		4096 Hz		10	
	512 Hz		01		32768 Hz		11	
WP1,WP0	Write Protect. These bits control the write protection of the memory array. Battery-backed, read/write.							
	<u>Write-Protect addresses</u>		<u>WP1</u>	<u>WP0</u>				
	None		0	0				
	Bottom 1/4		0	1				
	Bottom 1/2		1	0				
	Full array		1	1				
VBC	VBAK Charger Control: Setting VBC to 1 (and FC=0) causes approx. 80 $\mu$ A (1mA if FC=1) trickle charge current to be supplied on V <sub>BAK</sub> . Clearing VBC to 0 disables the charge current. Battery-backed, read/write.							
FC	Fast Charge: Setting FC to 1 (and VBC=1) causes approx. 1mA trickle charge current to be supplied on V <sub>BAK</sub> . Clearing VBC to 0 disables the charge current. Battery-backed, read/write.							
TST	Invokes factory test mode. Users should always set this bit to 0.							
<b>0Dh</b>	<b>Alarm – Month</b>							
	<b>D7</b>	<b>D6</b>	<b>D5</b>	<b>D4</b>	<b>D3</b>	<b>D2</b>	<b>D1</b>	<b>D0</b>
	<u>M</u>	0	0	10 Month	Month.3	Month.2	Month.1	Month.0
	Contains the alarm value for the month and the mask bit to select or deselect the Month value.							
/M	Match: Setting this bit to a ‘0’ causes the Month value to be used in the alarm match logic. Setting this bit to a ‘1’ causes the match circuit to ignore the Month value. Battery-backed, read/write.							
<b>0Ch</b>	<b>Alarm – Date</b>							
	<b>D7</b>	<b>D6</b>	<b>D5</b>	<b>D4</b>	<b>D3</b>	<b>D2</b>	<b>D1</b>	<b>D0</b>
	<u>M</u>	0	10 date.1	10 date.0	Date.3	Date.2	Date.1	Date.0
	Contains the alarm value for the date and the mask bit to select or deselect the Date value.							
/M	Match: Setting this bit to a ‘0’ causes the Date value to be used in the alarm match logic. Setting this bit to a ‘1’ causes the match circuit to ignore the Date value. Battery-backed, read/write.							
<b>0Bh</b>	<b>Alarm – Hours</b>							
	<b>D7</b>	<b>D6</b>	<b>D5</b>	<b>D4</b>	<b>D3</b>	<b>D2</b>	<b>D1</b>	<b>D0</b>
	<u>M</u>	0	10 hours.1	10 hours.0	Hours.3	Hours.2	Hours.1	Hours.0
	Contains the alarm value for the hours and the mask bit to select or deselect the Hours value.							
/M	Match: Setting this bit to a ‘0’ causes the Hours value to be used in the alarm match logic. Setting this bit to a ‘1’ causes the match circuit to ignore the Hours value. Battery-backed, read/write.							
<b>0Ah</b>	<b>Alarm – Minutes</b>							
	<b>D7</b>	<b>D6</b>	<b>D5</b>	<b>D4</b>	<b>D3</b>	<b>D2</b>	<b>D1</b>	<b>D0</b>
	<u>M</u>	10 min.2	10 min.1	10 min.0	Min.3	Min.2	Min.1	Min.0
	Contains the alarm value for the minutes and the mask bit to select or deselect the Minutes value							
/M	Match: Setting this bit to a ‘0’ causes the Minutes value to be used in the alarm match logic. Setting this bit to a ‘1’ causes the match circuit to ignore the Minutes value. Battery-backed, read/write.							

09h	<b>Alarm – Seconds</b>							
	D7	D6	D5	D4	D3	D2	D1	D0
	M	10 sec.2	10 sec.1	10 sec.0	Seconds.3	Seconds.2	Seconds.1	Seconds.0
Contains the alarm value for the seconds and the mask bit to select or deselect the Seconds value.								
/M	Match: Setting this bit to a '0' causes the Seconds value to be used in the alarm match logic. Setting this bit to a '1' causes the match circuit to ignore the Seconds value. Battery-backed, read/write.							

08h	<b>Timekeeping – Years</b>							
	D7	D6	D5	D4	D3	D2	D1	D0
	10 year.3	10 year.2	10 year.1	10 year.0	Year.3	Year.2	Year.1	Year.0
Contains the lower two BCD digits of the year. Lower nibble contains the value for years; upper nibble contains the value for 10s of years. Each nibble operates from 0 to 9. The range for the register is 0-99. Battery-backed, read/write.								

07h	<b>Timekeeping – Months</b>							
	D7	D6	D5	D4	D3	D2	D1	D0
	0	0	0	10 Month	Month.3	Month.2	Month.1	Month.0
Contains the BCD digits for the month. Lower nibble contains the lower digit and operates from 0 to 9; upper nibble (one bit) contains the upper digit and operates from 0 to 1. The range for the register is 1-12. Battery-backed, read/write.								

06h	<b>Timekeeping – Date of the month</b>							
	D7	D6	D5	D4	D3	D2	D1	D0
	0	0	10 date.1	10 date.0	Date.3	Date.2	Date.1	Date.0
Contains the BCD digits for the date of the month. Lower nibble contains the lower digit and operates from 0 to 9; upper nibble contains the upper digit and operates from 0 to 3. The range for the register is 1-31. Battery-backed, read/write.								

05h	<b>Timekeeping – Day of the week</b>							
	D7	D6	D5	D4	D3	D2	D1	D0
	0	0	0	0	0	Day.2	Day.1	Day.0
Lower nibble contains a value that correlates to day of the week. Day of the week is a ring counter that counts from 1 to 7 then returns to 1. The user must assign meaning to the day value, as the day is not integrated with the date. Battery-backed, read/write.								

04h	<b>Timekeeping – Hours</b>							
	D7	D6	D5	D4	D3	D2	D1	D0
	0	0	10 hours.1	10 hours.0	Hours.3	Hours.2	Hours.1	Hours.0
Contains the BCD value of hours in 24-hour format. Lower nibble contains the lower digit and operates from 0 to 9; upper nibble (two bits) contains the upper digit and operates from 0 to 2. The range for the register is 0-23. Battery-backed, read/write.								

03h	<b>Timekeeping – Minutes</b>							
	D7	D6	D5	D4	D3	D2	D1	D0
	0	10 min.2	10 min.1	10 min.0	Min.3	Min.2	Min.1	Min.0
Contains the BCD value of minutes. Lower nibble contains the lower digit and operates from 0 to 9; upper nibble contains the upper minutes digit and operates from 0 to 5. The range for the register is 0-59. Battery-backed, read/write.								

02h	<b>Timekeeping – Seconds</b>							
	D7	D6	D5	D4	D3	D2	D1	D0
	0	10 sec.2	10 sec.1	10 sec.0	Seconds.3	Seconds.2	Seconds.1	Seconds.0
Contains the BCD value of seconds. Lower nibble contains the lower digit and operates from 0 to 9; upper nibble contains the upper digit and operates from 0 to 5. The range for the register is 0-59. Battery-backed, read/write.								

01h	<b>CAL/Control</b>							
	D7	D6	D5	D4	D3	D2	D1	D0
	OSCEN	-	CALS	CAL.4	CAL.3	CAL.2	CAL.1	CAL.0
/OSCEN	Oscillator Enable. When set to 1, the oscillator is halted. When set to 0, the oscillator runs. Disabling the oscillator can save battery power during storage. On an initial power-up of V <sub>DD</sub> with or without V <sub>BAK</sub> , this bit is internally set to 1, which turns off the oscillator. Battery-backed, read/write.							

CALS	Calibration Sign: Determines if the calibration adjustment is applied as an addition to or as a subtraction from the time-base. This bit can be written only when CAL=1. Battery-backed, read/write.
CAL.4-0	Calibration Code: These five bits control the calibration of the clock. These bits can be written only when CAL=1. Battery-backed, read/write.

00h	RTC/Alarm Control							
	D7	D6	D5	D4	D3	D2	D1	D0
	LB	AF	CF	POR	AEN	CAL	W	R
LB	Low Battery Flag: If the V <sub>BAK</sub> source drops to a voltage level insufficient to operate the RTC/alarm, this bit will be set to '1'. All registers need to be re-initialized since the battery-backed register values should be treated as unknown. The user should clear it to '0' when initializing the system. Battery-backed. Read/Write (internally set, user can clear bit by writing to a '0').							
AF	Alarm Flag: This read-only bit is set to 1 when the time/date match the values stored in the alarm registers with the Match bit(s) = 0. It is cleared when the RTC/Alarm Control register is read. Battery-backed.							
CF	Century Overflow Flag: This read-only bit is set to a 1 when the values in the years register overflows from 99 to 00. This indicates a new century, such as going from 1999 to 2000 or 2099 to 2100. The user should record the new century information as needed. This bit is cleared when the RTC/Alarm Control register is read. Battery-backed.							
POR	Power On Reset Flag: When V <sub>DD</sub> drops below V <sub>SW</sub> , the POR bit will be set to '1'. Battery-backed. Read/Write (internally set, user can clear bit by writing to a '0').							
AEN	Alarm Enable: This bit enables the alarm function. When AEN is set (and CAL cleared), the ACS pin operates as an active-low alarm and the AF flag function is enabled. The function of the ACS pin is detailed in Table 3. When AEN is cleared, no new alarm events will occur but the AF flag and ACS pin will not be cleared. Battery-backed, read/write.							
CAL	Calibration Mode: When CAL is set to '1', the clock enters calibration mode. When CAL is set to '0', the clock operates normally, and the ACS pin is controlled by the RTC alarm. Battery-backed, read/write.							
W	Write RTC: Setting the W bit to '1' freezes updates of the user timekeeping registers. The user can then write them with updated values. Setting the W bit to '0' causes the contents of the time registers to be transferred to the timekeeping counters. Battery-backed, read/write.							
R	Read RTC: Setting the R bit to '1' copies a static image of the timekeeping core and place it into the user registers. The user can then read them without concerns over changing values causing system errors. The R bit going from '0' to '1' causes the timekeeping capture, so the bit must be returned to '0' prior to reading again. Battery-backed, read/write.							

## Two-wire Interface

The FM3135 employs an industry standard two-wire bus that is familiar to many users. This product is unique since it incorporates two logical devices in one chip. Each logical device can be accessed individually. Although monolithic, it appears to the system software to be two separate products. One is a memory device. It has a Slave Address (Slave ID = 1010b) that operates the same as a stand-alone memory device. The second device is a real-time clock and alarm which have a unique Slave Address (Slave ID = 1101b).

By convention, any device that is sending data onto the bus is the transmitter while the target device for this data is the receiver. The device that is controlling the bus is the master. The master is responsible for generating the clock signal for all operations. Any device on the bus that is being controlled is a slave. The FM3135 is always a slave device.

The bus protocol is controlled by transition states in the SDA and SCL signals. There are four conditions: Start, Stop, Data bit, and Acknowledge. The figure below illustrates the signal conditions that specify the four states. Detailed timing diagrams are shown in the Electrical Specifications section.

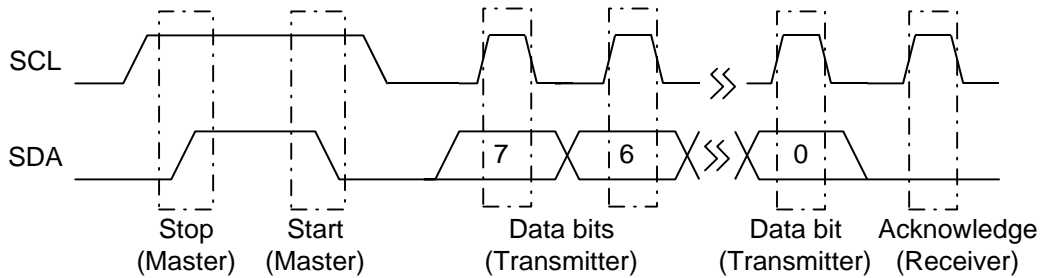

Figure 4. Data Transfer Protocol

### Start Condition

A Start condition is indicated when the bus master drives SDA from high to low while the SCL signal is high. All read and write transactions begin with a Start condition. An operation in progress can be aborted by asserting a Start condition at any time. Aborting an operation using the Start condition will ready the FM3135 for a new operation.

During this state the transmitter must release the SDA bus to allow the receiver to drive it. The receiver drives the SDA signal low to acknowledge receipt of the byte. If the receiver does not drive SDA low, the condition is a No-Acknowledge (NACK) and the operation is aborted.

### Stop Condition

A Stop condition is indicated when the bus master drives SDA from low to high while the SCL signal is high. All operations must end with a Stop condition. If an operation is pending when a stop is asserted, the operation will be aborted. The master must have control of SDA (not a memory read) in order to assert a Stop condition.

The receiver might NACK for two distinct reasons. First is that a byte transfer fails. In this case, the NACK ends the current operation so that the part can be addressed again. This allows the last byte to be recovered in the event of a communication error.

### Data/Address Transfer

All data transfers (including addresses) take place while the SCL signal is high. Except under the two conditions described above, the SDA signal should not change while SCL is high.

Second and most common, the receiver does not send an ACK to deliberately terminate an operation. For example, during a read operation, the FM3135 will continue to place data onto the bus as long as the receiver sends ACKs (and clocks). When a read operation is complete and no more data is needed, the receiver must NACK the last byte. If the receiver ACKs the last byte, this will cause the FM3135 to attempt to drive the bus on the next clock while the master is sending a new command such as a Stop.

### Acknowledge

The Acknowledge (ACK) takes place after the 8<sup>th</sup> data bit has been transferred in any transaction.

### Slave Address

The first byte that the FM3135 expects after a Start condition is the slave address. As shown in figures below, the slave address contains the Slave ID and a bit that specifies if the transaction is a read or a write.

The FM3135 has two Slave Addresses (Slave IDs) associated with two logical devices. To access the memory device, bits 7-4 should be set to 1010b. The other logical device within the FM3135 is the real-time clock and alarm. To access this device, bits 7-4 of the slave address should be set to 1101b. A bus transaction with this slave address will not affect the memory in any way. The figures below illustrate the two Slave Addresses.

Bits 3 through 1 of the Slave Address must be logic 0. Bit 0 is the read/write bit. A '1' indicates a read operation, and a '0' indicates a write operation.

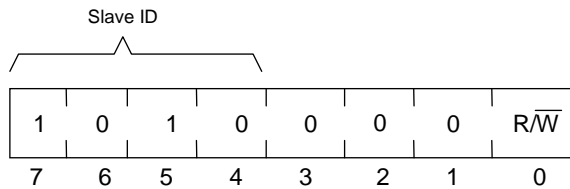

Figure 5. Slave Address – Memory

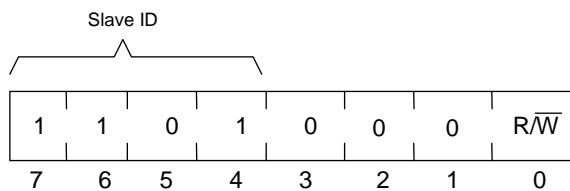

Figure 6. Slave Address – RTC

**Addressing Overview – Memory**

After the FM3135 acknowledges the Slave Address, the master can place the memory address on the bus for a write operation. The address requires two bytes. The first is the MSB (upper byte). The first 3 unused address bits are don't cares, but should be set to '0' to maintain upward compatibility. Following the MSB is the LSB (lower byte) which contains the remaining eight address bits. The address is latched internally. Each access causes the latched address to be incremented automatically. The current address is the value that is held in the latch, either a newly written value or the address following the last access. The current address will be held as long as V<sub>DD</sub> is greater than V<sub>SW</sub> or until a new value is written. Accesses to the clock do not affect the current memory address. Reads always use the current

address. A random read address can be loaded by beginning a write operation as explained below.

After transmission of each data byte, just prior to the Acknowledge, the FM3135 increments the internal address. This allows the next sequential byte to be accessed with no additional addressing externally. After the last address is reached, the address latch will roll over to 0000h. There is no limit to the number of bytes that can be accessed with a single read or write operation.

**Addressing Overview – RTC/Alarm**

The RTC/Alarm operates in a similar manner to the memory, except that it uses only one byte of address. Addresses 00h to 0Eh correspond to the RTC/Alarm and control registers. Attempting to load addresses above 0Eh is an illegal condition; the FM3135 will return a NACK and abort the 2-wire transaction.

**Data Transfer**

After the address information has been transmitted, data transfer between the bus master and the FM3135 begins. For a read, the FM3135 will place 8 data bits on the bus then wait for an ACK from the master. If the ACK occurs, the FM3135 will transfer the next byte. If the ACK is not sent, the FM3135 will end the read operation. For a write operation, the FM3135 will accept 8 data bits from the master then send an Acknowledge. All data transfer occurs MSB (most significant bit) first.

**Memory Write Operation**

All memory writes begin with a Slave Address, then a memory address. The bus master indicates a write operation by setting the slave address LSB to a '0'. After addressing, the bus master sends each byte of data to the memory and the memory generates an Acknowledge condition. Any number of sequential bytes may be written. If the end of the address range is reached internally, the address counter will wrap to 0000h. Internally, the actual memory write occurs after the 8<sup>th</sup> data bit is transferred. It will be complete before the Acknowledge is sent. Therefore, if the user desires to abort a write without altering the memory contents, this should be done using a Start or Stop condition prior to the 8<sup>th</sup> data bit. The figures below illustrate a single- and multiple-writes to memory.

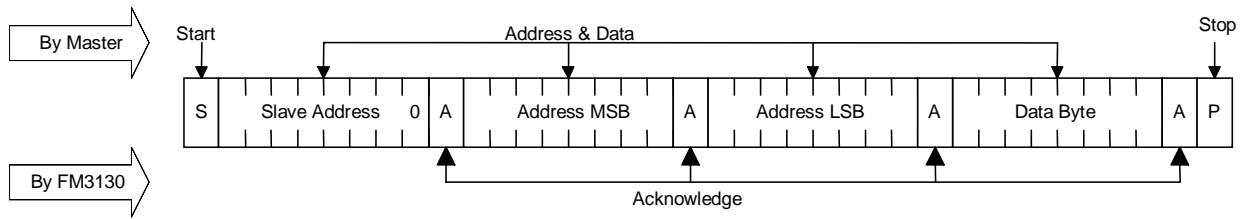

Figure 7. Single Byte Memory Write

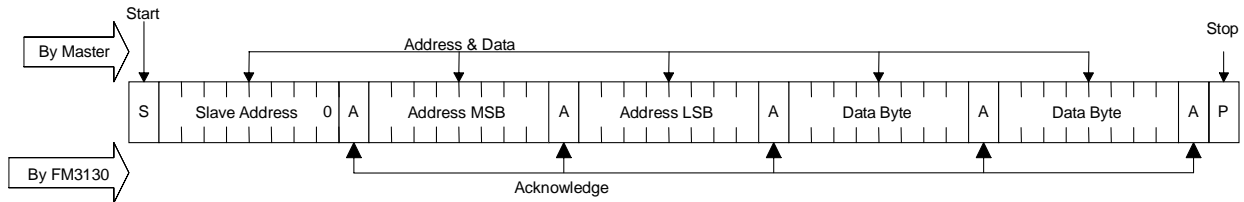

Figure 8. Multiple Byte Memory Write

**Memory Read Operation**

There are two types of memory read operations. They are current address read and selective address read. In a current address read, the FM3135 uses the internal address latch to supply the address. In a selective read, the user performs a procedure to first set the address to a specific value.

Current Address & Sequential Read

As mentioned above the FM3135 uses an internal latch to supply the address for a read operation. A current address read uses the existing value in the address latch as a starting place for the read operation. The system reads from the address immediately following that of the last operation.

To perform a current address read, the bus master supplies a slave address with the LSB set to 1. This indicates that a read operation is requested. After receiving the complete device address, the FM3135 will begin shifting data out from the current address on the next clock. The current address is the value held in the internal address latch.

Beginning with the current address, the bus master can read any number of bytes. Thus, a sequential read is simply a current address read with multiple byte transfers. After each byte the internal address counter will be incremented.

*Each time the bus master acknowledges a byte, this indicates that the FM3135 should read out the next sequential byte.*

There are four ways to terminate a read operation. Failing to properly terminate the read will most likely create a bus contention as the FM3135 attempts to read out additional data onto the bus. The four valid methods follow.

1. The bus master issues a NACK in the 9<sup>th</sup> clock cycle and a Stop in the 10<sup>th</sup> clock cycle. This is illustrated in the diagrams below and is preferred.
2. The bus master issues a NACK in the 9<sup>th</sup> clock cycle and a Start in the 10<sup>th</sup>.
3. The bus master issues a Stop in the 9<sup>th</sup> clock cycle.
4. The bus master issues a Start in the 9<sup>th</sup> clock cycle.

If the internal address reaches the top of memory, it will wrap around to 0000h on the next read cycle. The figures below show the proper operation for current address reads.

Selective (Random) Read

There is a simple technique that allows a user to select a random address location as the starting point for a read operation. This involves using the first three bytes of a write operation to set the internal address followed by subsequent read operations.

To perform a selective read, the bus master sends out the slave address with the LSB set to 0. This specifies a write operation. According to the write protocol, the bus master then sends the address bytes that are loaded into the internal address latch. After the FM3135 acknowledges the address, the bus master

issues a Start condition. This simultaneously aborts the write operation and allows the read command to be issued with the slave address LSB set to a '1'. The operation is now a read from the current address. Read operations are illustrated below.

**RTC/Alarm Write Operation**

All RTC/Alarm writes operate in a similar manner to memory writes. The distinction is that a different device ID is used and only one byte address is needed instead of two. Figure 12 illustrates a single byte write to the RTC/Alarm.

**RTC/Alarm Read Operation**

As with writes, a read operation begins with the Slave Address. To perform a register read, the bus master supplies a Slave Address with the LSB set to a '1'. This indicates that a read operation is requested. After receiving the complete Slave Address, the

FM3135 will begin shifting data out from the current register address on the next clock. Auto-increment operates for the special function registers as with the memory address. A current address read for the registers look exactly like the memory except that the device ID is different.

The FM3135 contains two separate address registers, one for the memory address and the other for the register address. This allows the contents of one address register to be modified without affecting the current address of the other register. For example, this would allow an interrupted read to the memory while still providing fast access to an RTC register. A subsequent memory read will then continue from the memory address where it previously left off, without requiring the load of a new memory address. However, a write sequence always requires an address to be supplied.

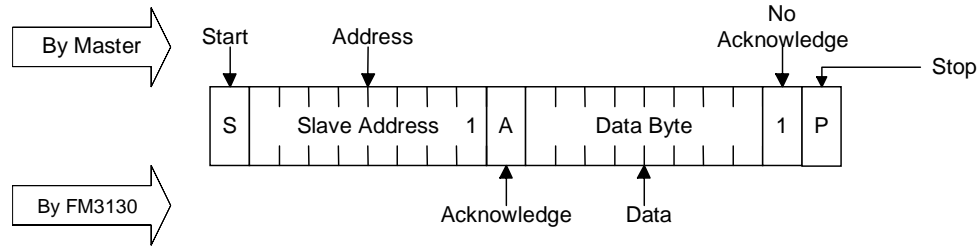

**Figure 9. Current Address Memory Read**

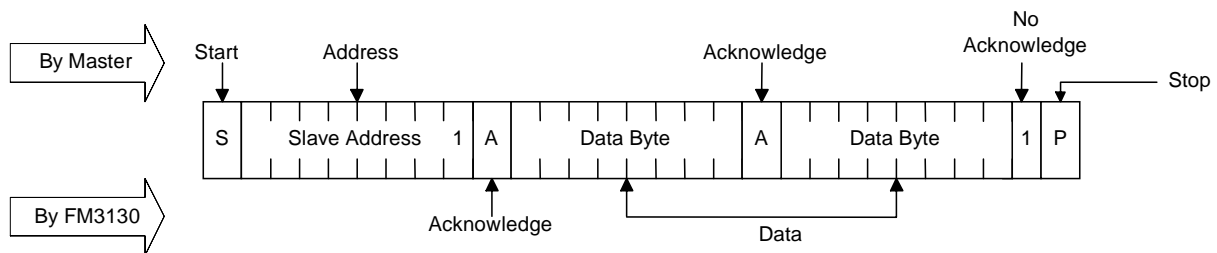

**Figure 10. Sequential Memory Read**

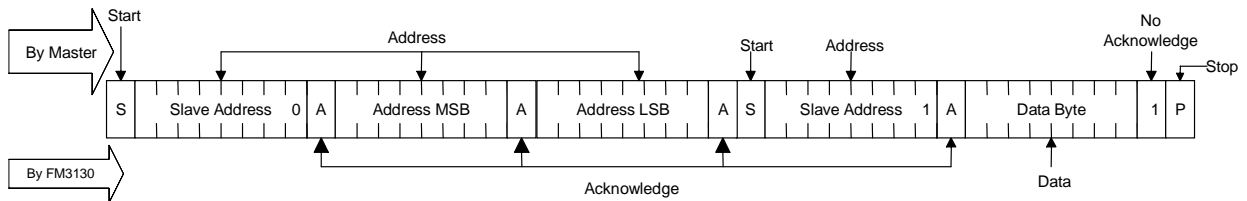

**Figure 11. Selective (Random) Memory Read**

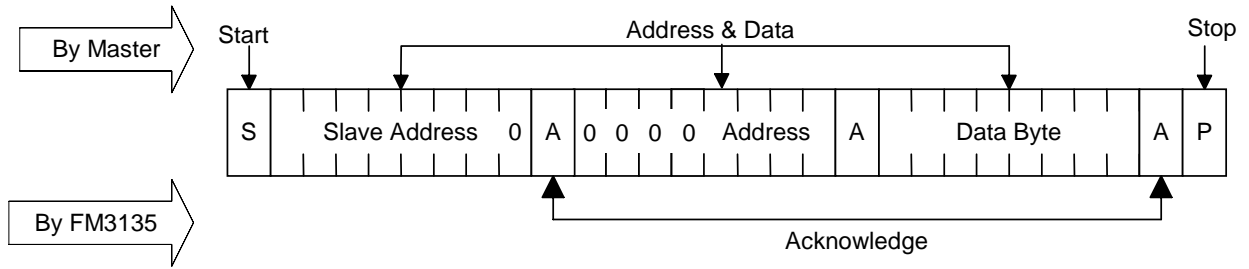

**Figure 12. Register Byte Write**

\* Although not required, it is recommended that A7-A4 in the Register Address byte are zeros in order to preserve compatibility with future devices.



## Electrical Specifications

### Absolute Maximum Ratings

Symbol	Description	Ratings
$V_{DD}$	Power Supply Voltage with respect to $V_{SS}$	-1.0V to +5.0V
$V_{IN}$	Voltage on any signal pin with respect to $V_{SS}$	-1.0V to +5.0V * and $V_{IN} \leq V_{DD} + 1.0V$ **
$V_{BAK}$	Backup Supply Voltage	-1.0V to +4.5V
$T_{STG}$	Storage Temperature	-55°C to +125°C
$T_{LEAD}$	Lead Temperature (Soldering, 10 seconds)	300° C
$V_{ESD}$	Electrostatic Discharge Voltage - Human Body Model (JEDEC Std JESD22-A114-B) - Charged Device Model (JEDEC Std JESD22-C101-A) - Machine Model (JEDEC Std JESD22-A115-A)	4kV 1kV 200V
	Package Moisture Sensitivity Level	TBD

\*\* The " $V_{IN} < V_{DD} + 1.0V$ " restriction does not apply to the SCL, SDA, and ACS pins which do not employ a diode to  $V_{DD}$ .

Stresses above those listed under Absolute Maximum Ratings may cause permanent damage to the device. This is a stress rating only, and the functional operation of the device at these or any other conditions above those listed in the operational section of this specification is not implied. Exposure to absolute maximum ratings conditions for extended periods may affect device reliability.

### DC Operating Conditions ( $T_A = -40^\circ\text{C}$ to $+85^\circ\text{C}$ , $V_{DD} = 2.7\text{V}$ to $3.6\text{V}$ unless otherwise specified)

Symbol	Parameter	Min	Typ	Max	Units	Notes
$V_{DD}$	Main Power Supply	2.7	-	3.6	V	1
$I_{DD}$	$V_{DD}$ Supply Current @ SCL = 100 kHz @ SCL = 1 MHz			150 500	$\mu\text{A}$ $\mu\text{A}$	2
$I_{SB}$	Standby Current Trickle Charger Off (VBC=0) Trickle Chrg On, Fast Chrg Off (VBC=1, FC=0) Trickle Chrg On, Fast Chrg On (VBC=1, FC=1)			50 190 2600	$\mu\text{A}$ $\mu\text{A}$ $\mu\text{A}$	3
$V_{BAK}$	RTC Backup Supply Voltage	2.0	3.0	3.6	V	4
$I_{BAK}$	RTC Backup Supply Current			1	$\mu\text{A}$	5
$I_{BAKTC}$	Trickle Charge Current with $V_{BAK}=0\text{V}$ Fast Charge Off (FC = 0) Fast Charge On (FC = 1)	25 200		120 2500	$\mu\text{A}$ $\mu\text{A}$	6
$I_{LI}$	Input Leakage Current			$\pm 1$	$\mu\text{A}$	7
$I_{LO}$	Output Leakage Current			$\pm 1$	$\mu\text{A}$	7
$V_{IH}$	Input High Voltage	$0.7 V_{DD}$		$V_{DD} + 0.3$	V	
$V_{IL}$	Input Low Voltage	-0.3		$0.3 V_{DD}$	V	
$V_{OL1}$	Output Low Voltage ( $I_{OL} = 3\text{ mA}$ ) - Applies to SDA and ACS pin - $V_{DD} > V_{SW}$	-		0.4	V	
$V_{OL2}$	Output Low Voltage ( $I_{OL} = 80\ \mu\text{A}$ ) - Applies only to ACS pin - $V_{BAK}$ applied, $V_{DD} < V_{SW}$	-		0.4	V	
$V_{SW}$	Battery Switchover Voltage	2.0		2.7	V	

#### Notes

- Full complete operation. RTC operates to lower voltages as specified.
- SCL toggling between  $V_{DD}-0.3\text{V}$  and  $V_{SS}$ , other inputs  $V_{SS}$  or  $V_{DD}-0.3\text{V}$ . VBC=0.  $I_{DD}$  is linear vs frequency.
- All inputs at  $V_{SS}$  or  $V_{DD}$ , static. Stop command issued.
- The VBAK trickle charger automatically regulates the maximum voltage on this pin for capacitor backup applications.
- $V_{BAK} = 3.0\text{V}$ ,  $V_{DD} < V_{SW}$ , oscillator running.
- $V_{BAK}$  will source current when the trickle charger is enabled (VBC=1),  $V_{DD} > V_{BAK}$  and  $V_{DD} > V_{SW}$ .
- $V_{IN}$  or  $V_{OUT} = V_{SS}$  to  $V_{DD}$ .

**AC Parameters** ( $T_A = -40^\circ\text{C}$  to  $+85^\circ\text{C}$ ,  $V_{DD} = 2.7\text{V}$  to  $3.6\text{V}$ ,  $C_L = 100\text{pF}$  unless otherwise specified)

Symbol	Parameter	Min	Max	Min	Max	Min	Max	Units	Notes
$f_{SCL}$	SCL Clock Frequency	0	100	0	400	0	1000	kHz	
$t_{LOW}$	Clock Low Period	4.7		1.3		0.6		$\mu\text{s}$	
$t_{HIGH}$	Clock High Period	4.0		0.6		0.4		$\mu\text{s}$	
$t_{AA}$	SCL Low to SDA Data Out Valid		3		0.9		0.55	$\mu\text{s}$	
$t_{BUF}$	Bus Free Before New Transmission	4.7		1.3		0.5		$\mu\text{s}$	
$t_{HD:STA}$	Start Condition Hold Time	4.0		0.6		0.25		$\mu\text{s}$	
$t_{SU:STA}$	Start Condition Setup for Repeated Start	4.7		0.6		0.25		$\mu\text{s}$	
$t_{HD:DAT}$	Data In Hold Time	0		0		0		ns	
$t_{SU:DAT}$	Data In Setup Time	250		100		100		ns	
$t_R$	Input Rise Time		1000		300		300	ns	1
$t_F$	Input Fall Time		300		300		100	ns	1
$t_{SU:STO}$	Stop Condition Setup Time	4.0		0.6		0.25		$\mu\text{s}$	
$t_{DH}$	Data Output Hold (from SCL @ VIL)	0		0		0		ns	
$t_{SP}$	Noise Suppression Time Constant on SCL, SDA		50		50		50	ns	

All SCL specifications as well as start and stop conditions apply to both read and write operations.

**Supervisor Timing** ( $T_A = -40^\circ\text{C}$  to  $+85^\circ\text{C}$ ,  $V_{DD} = 2.7\text{V}$  to  $3.6\text{V}$ )

Symbol	Parameter	Min	Max	Units	Notes
$t_{VR}$	$V_{DD}$ Rise Time	50	-	$\mu\text{s}/\text{V}$	1,2
$t_{VF}$	$V_{DD}$ Fall Time	100	-	$\mu\text{s}/\text{V}$	1,2
$t_{RPU}$	Device active after $V_{DD} > 2.7\text{V}$	-	20	ms	

**Capacitance** ( $T_A = 25^\circ\text{C}$ ,  $f = 1.0\text{MHz}$ ,  $V_{DD} = 3.0\text{V}$ )

Symbol	Parameter	Typ	Max	Units	Notes
$C_{IO}$	Input/Output Capacitance	-	8	pF	1

**Notes**

- 1 This parameter is characterized but not tested.
- 2 Slope measured at any point on  $V_{DD}$  waveform.

**Data Retention** ( $V_{DD} = 2.7\text{V}$  to  $3.6\text{V}$ )

Symbol	Parameter	Min	Units	Notes
$T_{DR}$	Data Retention			
	@ $+75^\circ\text{C}$	45	Years	
	@ $+80^\circ\text{C}$	20	Years	
	@ $+85^\circ\text{C}$	10	Years	

AC Test Conditions

Input Pulse Levels	0.1 V <sub>DD</sub> to 0.9 V <sub>DD</sub>
Input rise and fall times	10 ns
Input and output timing levels	0.5 V <sub>DD</sub>

Equivalent AC Test Load Circuit

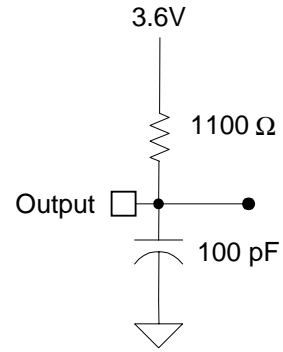
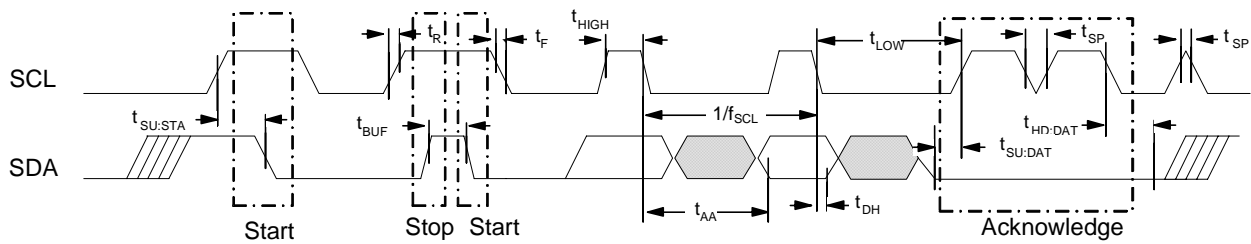

Diagram Notes

All start and stop timing parameters apply to both read and write cycles. Clock specifications are identical for read and write cycles. Write timing parameters apply to slave address, word address, and write data bits. Functional relationships are illustrated in the relevant data sheet sections. These diagrams illustrate the timing parameters only.

Read Bus Timing



Write Bus Timing

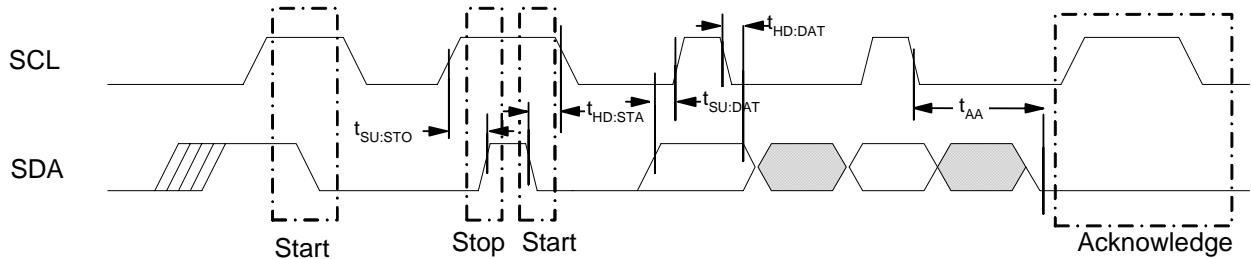

Power Cycle Timing

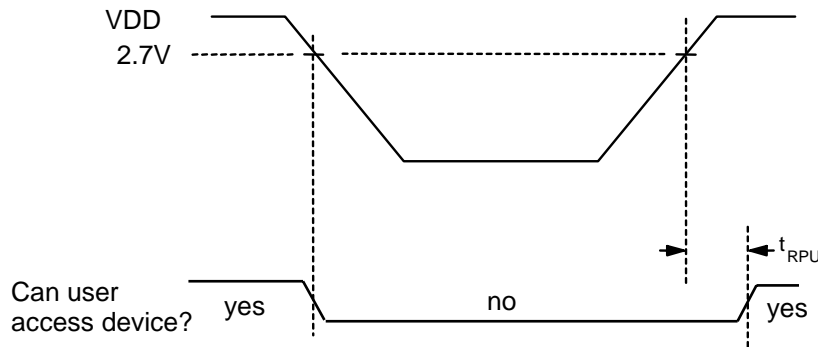

**Mechanical Drawing**

**20-pin SOIC (JEDEC Standard MS-013d variation AC)**

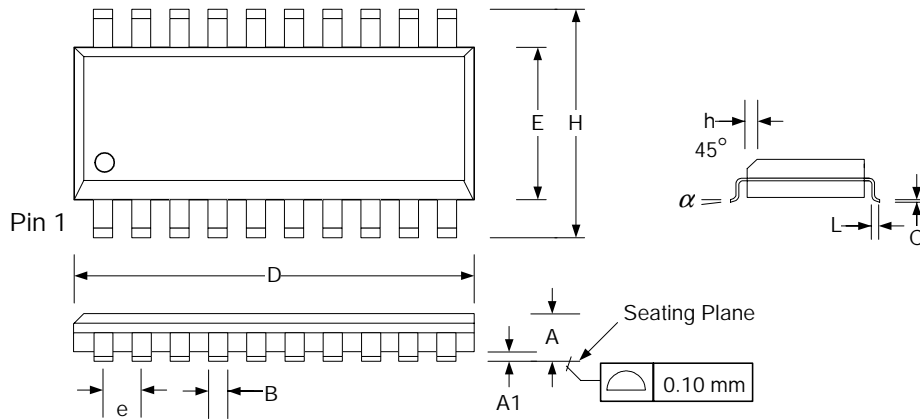

Refer to JEDEC MS-013 for complete dimensions and notes.  
All dimensions in millimeters.

Symbol	Dim	Min	Nom.	Max
A	mm	2.35		2.65
A1	mm	0.10		0.30
B	mm	0.33		0.51
C	mm	0.23		0.32
D	mm		12.8 BSC	
E	mm	7.40		7.60
e	mm in.		1.27 BSC 0.050 BSC	
H	mm	10.00		10.65
h	mm	0.25		0.75
L	mm	0.40		1.27
α		0°		8°

**SOIC Package Marking Scheme**

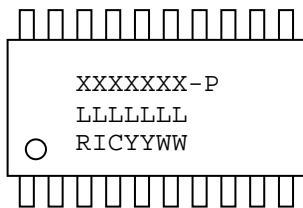

Legend:  
 XXXX= part number, P= package type  
 LLLLLLL= lot code  
 RIC=Ramtron Int'l Corp, YY=year, WW=work week

Example: FM3135, "Green" SOIC package, Year 2007, Work Week 14  
 FM3135-G  
 A70003G  
 RIC0714

**Revision History**

<b>Revision</b>	<b>Date</b>	<b>Summary</b>
0.1	12/14/2006	Initial release.
1.0	12/19/2007	Changed to Preliminary status. Changed pinout. Added ESD ratings.
1.1	2/29/2008	Updated ESD ratings.
1.2	2/9/2009	Added tape and reel ordering information. Expanded data retention ratings. Added UL Recognition of trickle charger.