



# EMR101\_C

## DC – 26GHz VOLTAGE VARIABLE ATTENUATOR MMIC

### FEATURES

- Broadband Performance: DC-26GHz
- Wide Attenuation Range: 25dB
- Low Insertion Loss: 2.5dB
- Good Return Loss: 10dB

### APPLICATIONS

- Point-to-point and point-to-multipoint radio

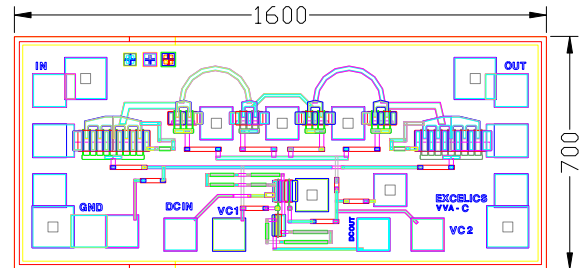

### ELECTRICAL CHARACTERISTICS (T<sub>a</sub> = 25 °C)

PARAMETERS/TEST CONDITIONS		MIN	TYP	MAX	UNIT
Operating Frequency Range		DC		26	GHz
Input Power at 1dB Compression		6	8		dBm
Input Power at 0.25dB Compression		-5	-2		dBm
Minimum Attenuation	(DC - 8GHz)		1.5	2.5	dB
	(8 - 26GHz)		2.5	3.5	dB
Maximum Attenuation	(DC – 8GHz)		25	30	dB
	(8 - 26GHz)		30	35	dB
Return Loss	@min. attenuation	10	15		dB
	@max. attenuation	10	12		dB

### ABSOLUTE MAXIMUM RATINGS FOR CONTINUOUS OPERATION<sup>1,2</sup>

RF Input Power	+16dBm
Control Voltage	+1.0 to -8 Volts
Storage Temperature	-65 to 150 deg C
Operating Temperature	-55 to +125 deg C

1. Operating the device beyond any of the above rating may result in permanent damage.



# EMR101\_C

## DC – 26GHz VOLTAGE VARIABLE ATTENUATOR MMIC

INSERTION LOSS

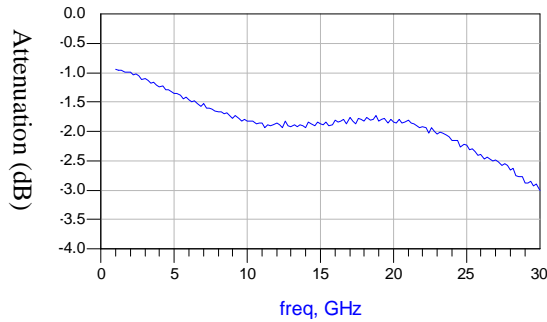

ATTENUATION RANGE

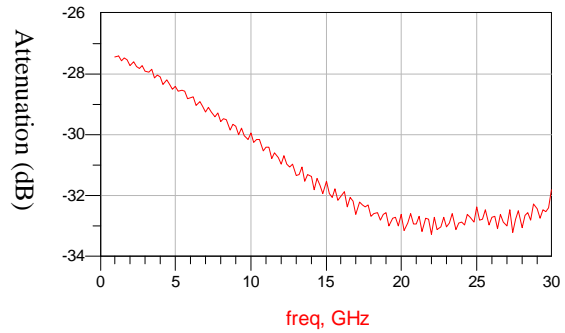

RETURN LOSS

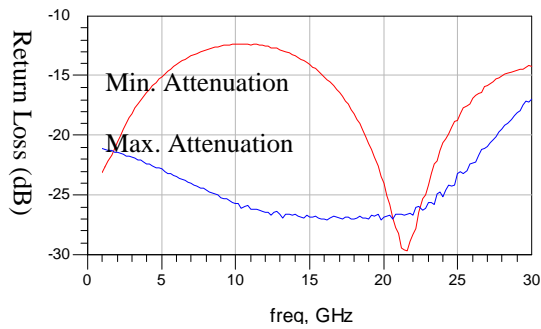

RELATIVE ATTENUATION

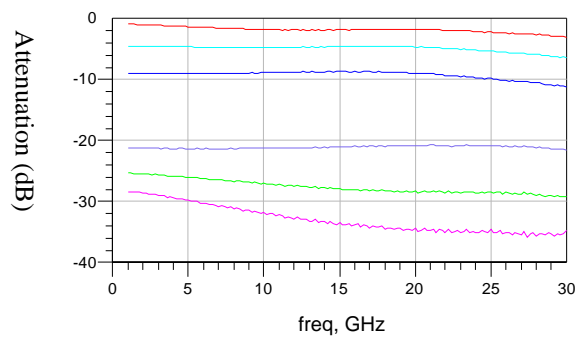

RELATIVE ATTENUATION VS. CONTROL VOLTAGE @2GHz

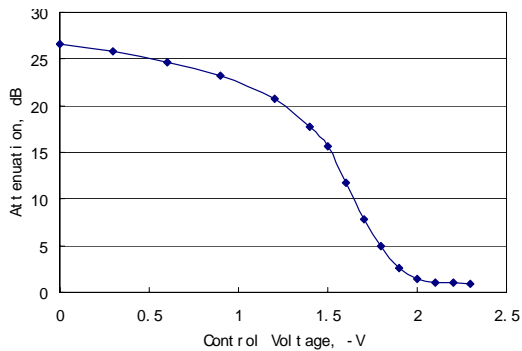

RELATIVE PHASE

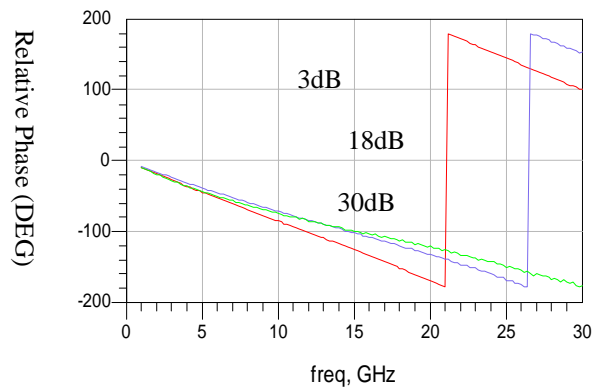



## DC – 26GHz VOLTAGE VARIABLE ATTENUATOR MMIC

Input Power at 1dB and 0.25dB Compression VS. Attenuation

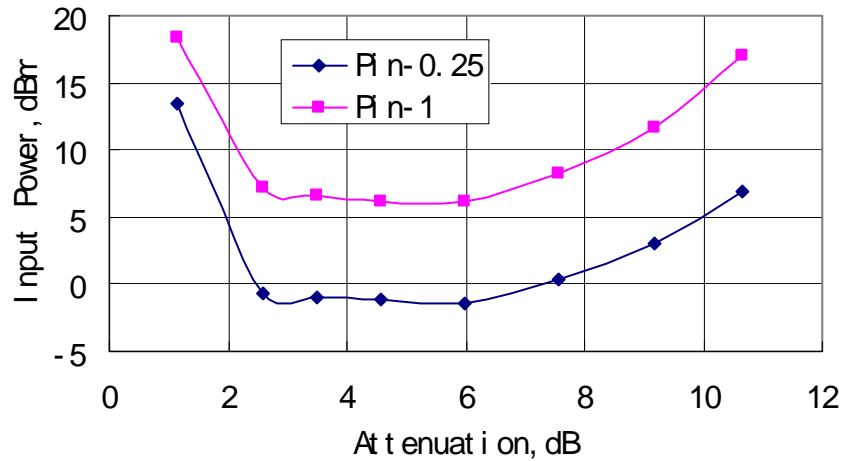

Pout and Attenuation VS. Pin at High Attenuation Setting

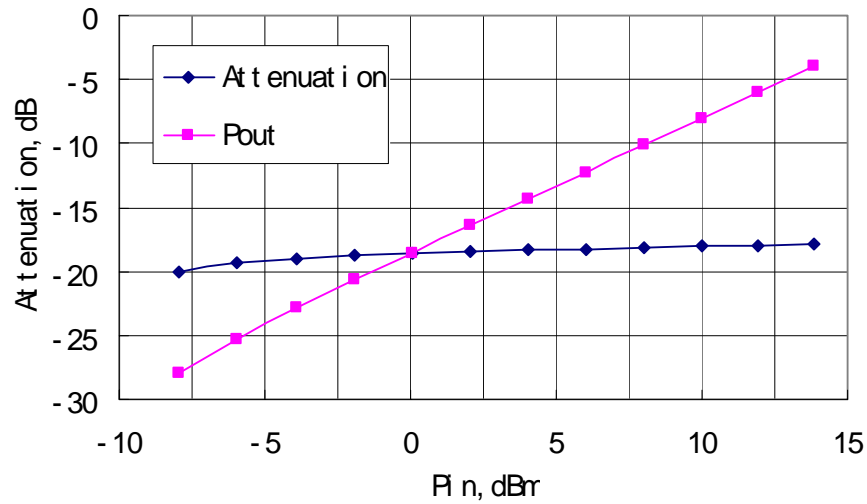



# EMR101\_C

## DC – 26GHz VOLTAGE VARIABLE ATTENUATOR MMIC

### Outline Drawing

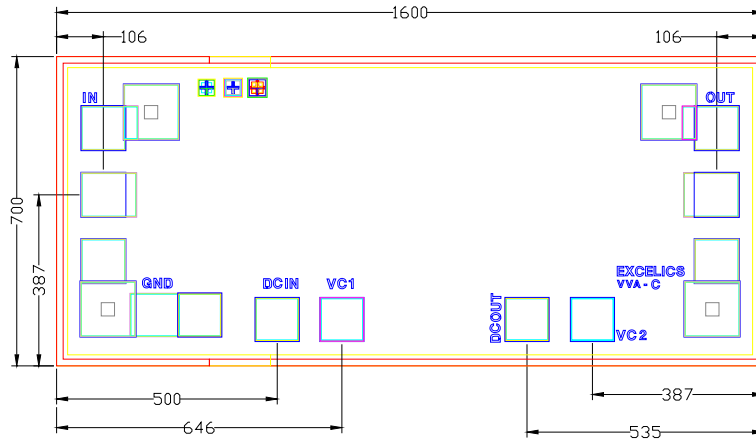

All dimensions in microns  
 Bond pads are 100microns by 100microns  
 Die thickness is  $75 \pm 13$  microns  
 Backside metallization: GOLD  
 Bond pads metallization: GOLD

### External Op-amp Driver

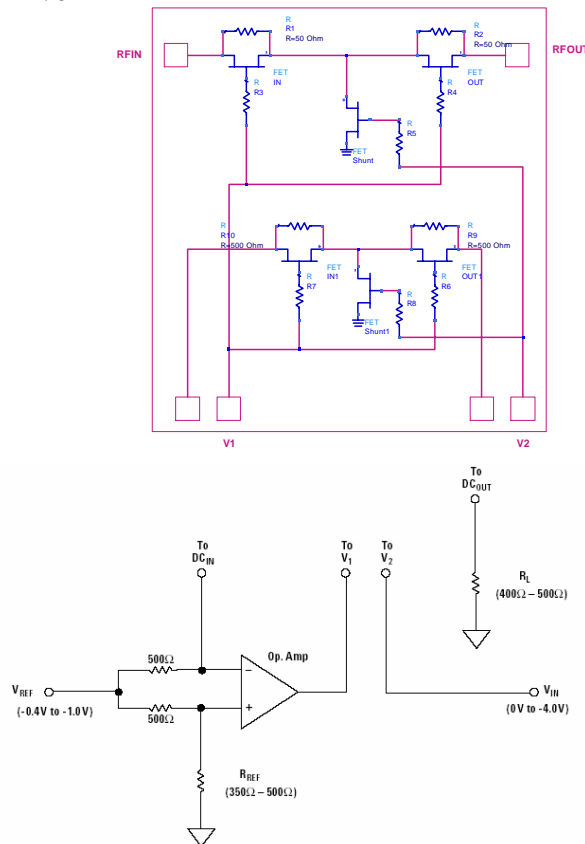

External op-amp control circuit works with on chip reference circuit to maintain impedance match while attenuation is varied. Input control voltage ranges from 0V (max. attenuation) to -4V (min. attenuation).