

## BCR5PM-14LD

Triac

Medium Power Use

REJ03G1563-0100

Rev.1.00

Jul 06, 2007

### Features

- $I_{T(RMS)}$  : 5 A
- $V_{DRM}$  : 700 V
- $I_{FGTI}$ ,  $I_{RGTI}$ ,  $I_{RGTIII}$  : 50 mA
- $V_{ISO}$  : 2000 V
- The product guaranteed maximum junction temperature 150°C.
- Insulated Type
- Planar Type

### Outline

RENESAS Package code: PRSS0003AA-A  
(Package name: TO-220F )



1. T<sub>1</sub> Terminal
2. T<sub>2</sub> Terminal
3. Gate Terminal

### Applications

Motor control, heater control

### Maximum Ratings

Parameter	Symbol	Voltage class	Unit
		14	
Repetitive peak off-state voltage <sup>Note1</sup>	$V_{DRM}$	700	V
Non-repetitive peak off-state voltage <sup>Note1</sup>	$V_{DSM}$	800	V

Parameter	Symbol	Ratings	Unit	Conditions
RMS on-state current	$I_T$ (RMS)	5	A	Commercial frequency, sine full wave 360° conduction, $T_c = 107^\circ\text{C}$
Surge on-state current	$I_{TSM}$	30	A	60Hz sinewave 1 full cycle, peak value, non-repetitive
$I^2t$ for fusing	$I^2t$	3.7	$\text{A}^2\text{s}$	Value corresponding to 1 cycle of half wave 60Hz, surge on-state current
Peak gate power dissipation	$P_{GM}$	5	W	
Average gate power dissipation	$P_{G(AV)}$	0.5	W	
Peak gate voltage	$V_{GM}$	10	V	
Peak gate current	$I_{GM}$	2	A	
Junction temperature	$T_j$	- 40 to +150	$^\circ\text{C}$	
Storage temperature	$T_{stg}$	- 40 to +150	$^\circ\text{C}$	
Mass	—	2.0	g	Typical value
Isolation voltage	Viso	2000	V	$T_a = 25^\circ\text{C}$ , AC 1 minute, $T_1$ - $T_2$ -G terminal to case

Notes: 1. Gate open.

## Electrical Characteristics

Parameter	Symbol	Min.	Typ.	Max.	Unit	Test conditions
Repetitive peak off-state current	$I_{DRM}$	—	—	2.0	mA	$T_j = 125^\circ\text{C}$ , $V_{DRM}$ applied
On-state voltage	$V_{TM}$	—	—	1.8	V	$T_c = 25^\circ\text{C}$ , $I_{TM} = 7\text{ A}$ , Instantaneous measurement
Gate trigger voltage <sup>Note2</sup>	I	$V_{FGTI}$	—	—	1.5	$T_j = 25^\circ\text{C}$ , $V_D = 6\text{ V}$ , $R_L = 6\ \Omega$ , $R_G = 330\ \Omega$
	II	$V_{RGTI}$	—	—	1.5	
	III	$V_{RGTIII}$	—	—	1.5	
Gate trigger current <sup>Note2</sup>	I	$I_{FGTI}$	—	—	50	$T_j = 25^\circ\text{C}$ , $V_D = 6\text{ V}$ , $R_L = 6\ \Omega$ , $R_G = 330\ \Omega$
	II	$I_{RGTI}$	—	—	50	
	III	$I_{RGTIII}$	—	—	50	
Gate non-trigger voltage	$V_{GD}$	0.2	—	—	V	$T_j = 125^\circ\text{C}$ , $V_D = 1/2 V_{DRM}$
Thermal resistance	$R_{th(j-c)}$	—	—	5.2	$^\circ\text{C}/\text{W}$	Junction to case <sup>Note3</sup>
Critical-rate of rise of off-state commutating voltage <sup>Note4</sup>	$(dv/dt)_c$	5	—	—	$\text{V}/\mu\text{s}$	$T_j = 125^\circ\text{C}$

Notes: 2. Measurement using the gate trigger characteristics measurement circuit.

3. The contact thermal resistance  $R_{th(c-f)}$  in case of greasing is  $0.5^\circ\text{C}/\text{W}$ .

4. Test conditions of the critical-rate of rise of off-state commutating voltage is shown in the table below.

Test conditions	Commutating voltage and current waveforms (inductive load)
1. Junction temperature $T_j = 125^\circ\text{C}$ 2. Rate of decay of on-state commutating current $(di/dt)_c = -2.5\text{ A/ms}$ 3. Peak off-state voltage $V_D = 400\text{ V}$	

Performance Curves

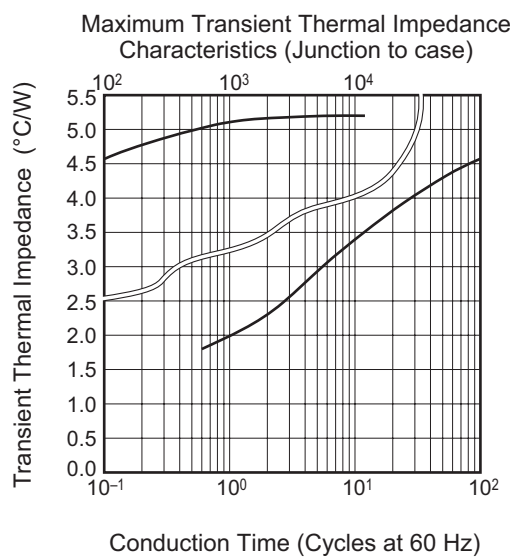
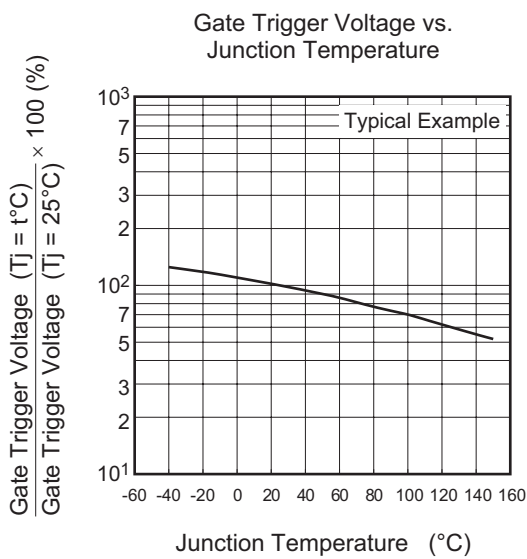
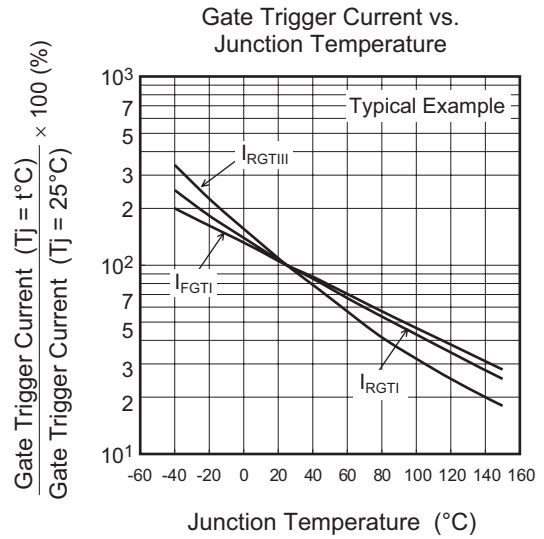
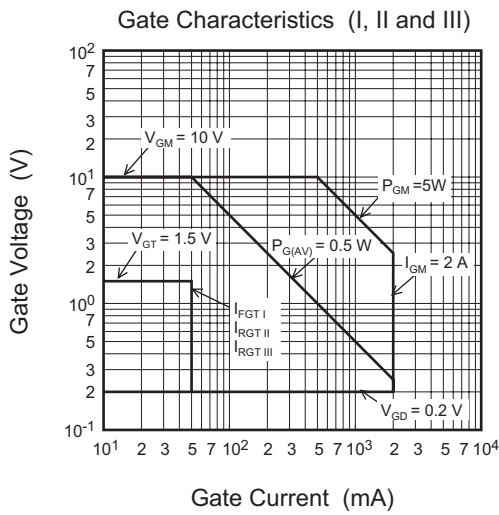
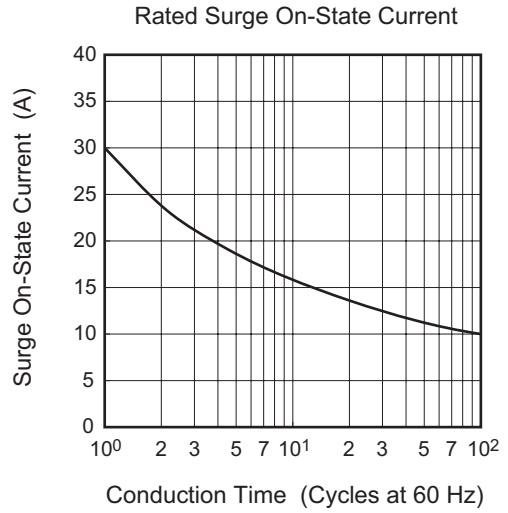
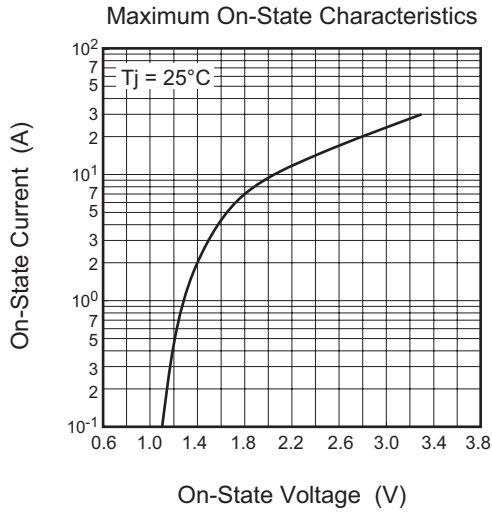

Maximum Transient Thermal Impedance Characteristics (Junction to ambient)

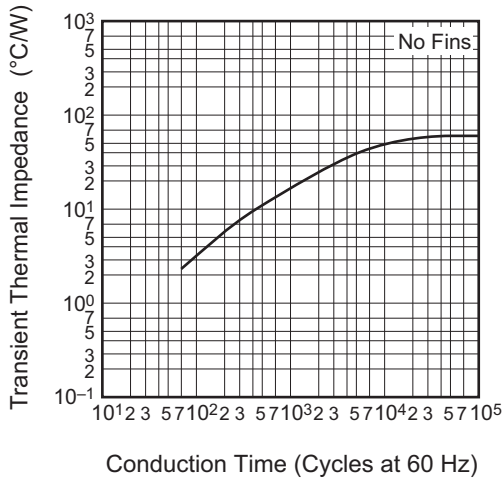

Maximum On-State Power Dissipation

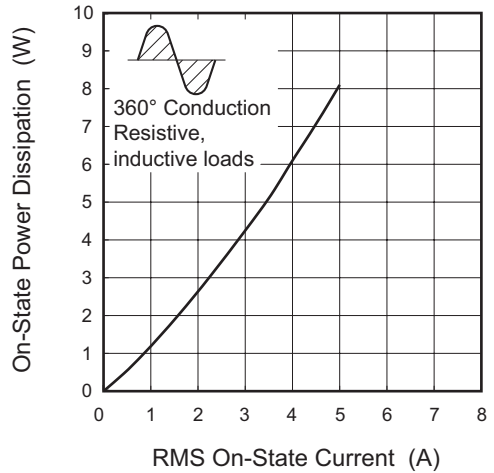

Allowable Case Temperature vs. RMS On-State Current

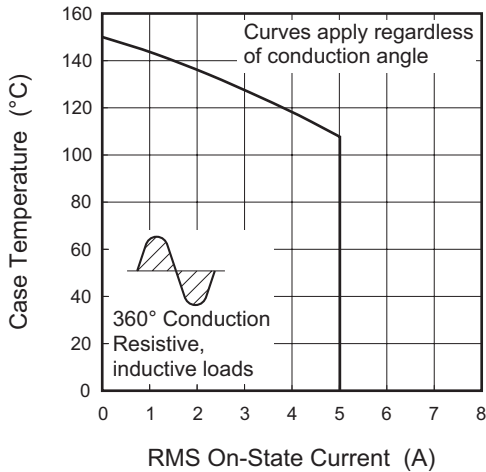

Allowable Ambient Temperature vs. RMS On-State Current

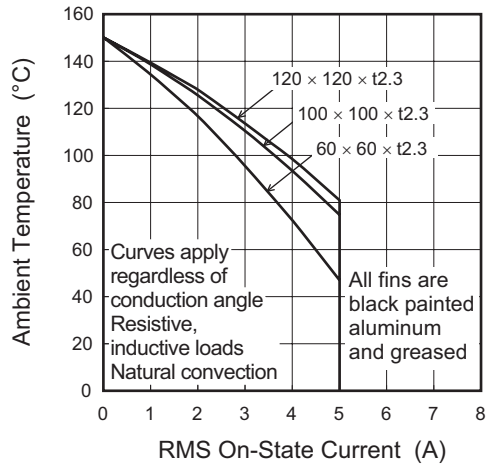

Allowable Ambient Temperature vs. RMS On-State Current

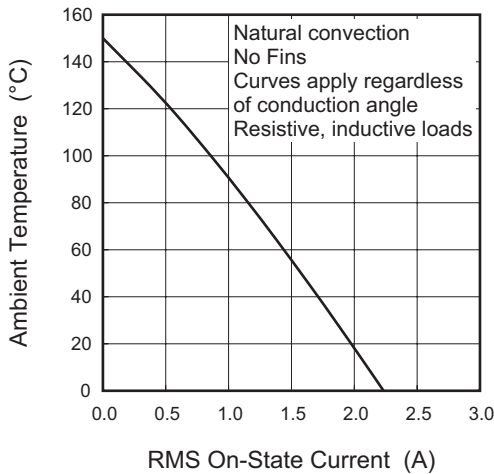

Repetitive Peak Off-State Current vs. Junction Temperature

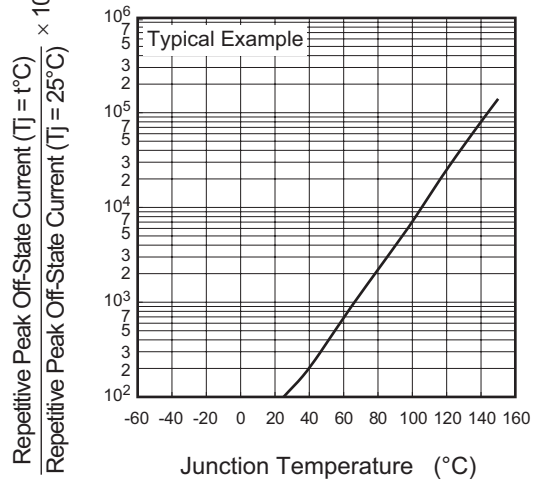

Holding Current vs. Junction Temperature

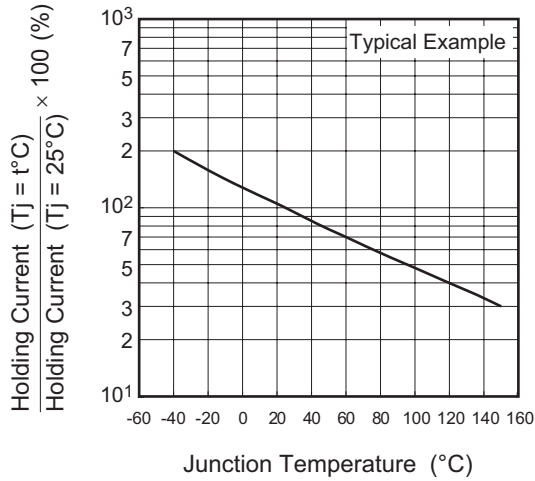

Latching Current vs. Junction Temperature

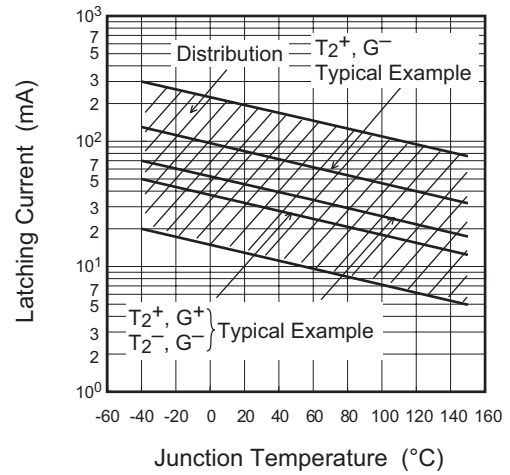

Breakover Voltage vs. Junction Temperature

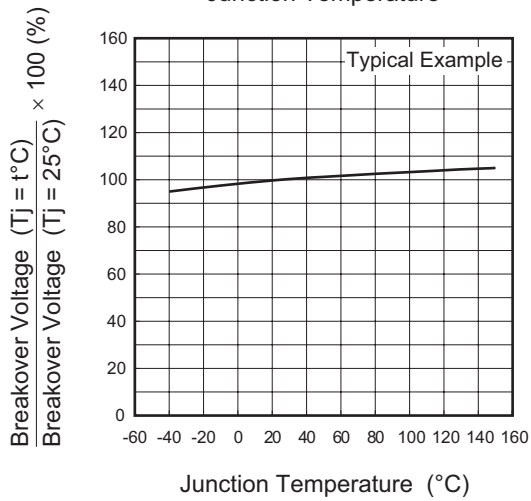

Breakover Voltage vs. Rate of Rise of Off-State Voltage (Tj = 125°C)

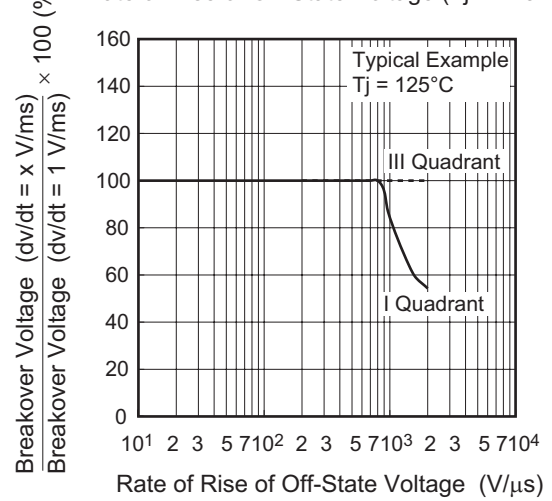

Breakover Voltage vs. Rate of Rise of Off-State Voltage (Tj = 150°C)

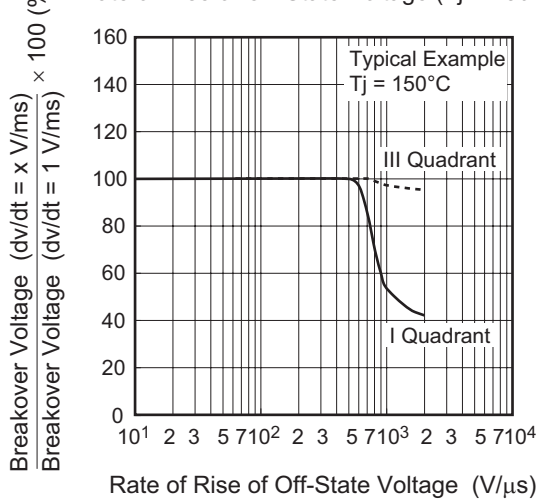

Commutation Characteristics (Tj = 125°C)

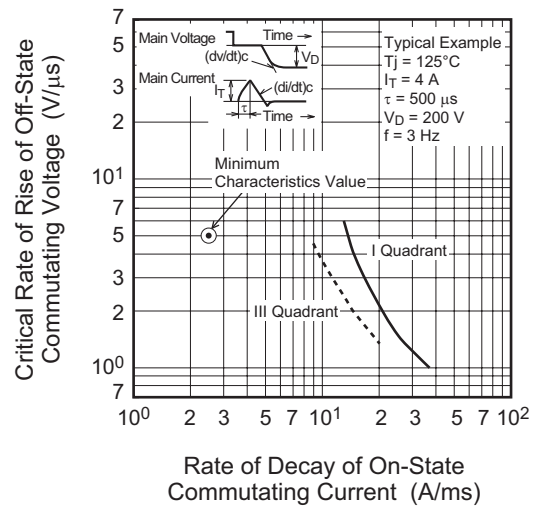

Commutation Characteristics ( $T_j = 150^\circ\text{C}$ )

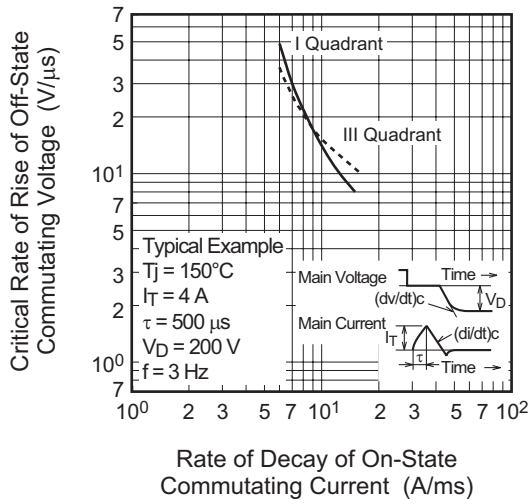

Gate Trigger Current vs. Gate Current Pulse Width

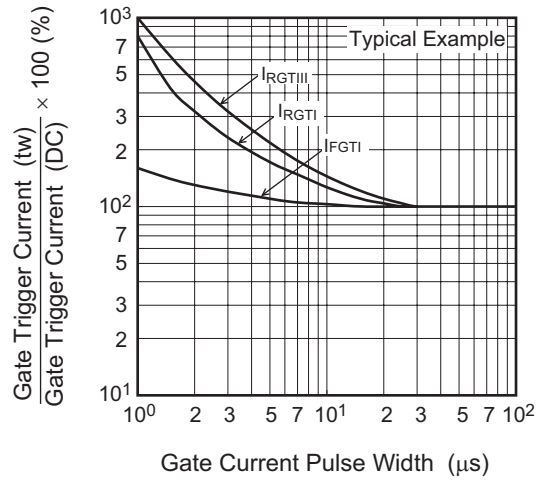

Gate Trigger Characteristics Test Circuits

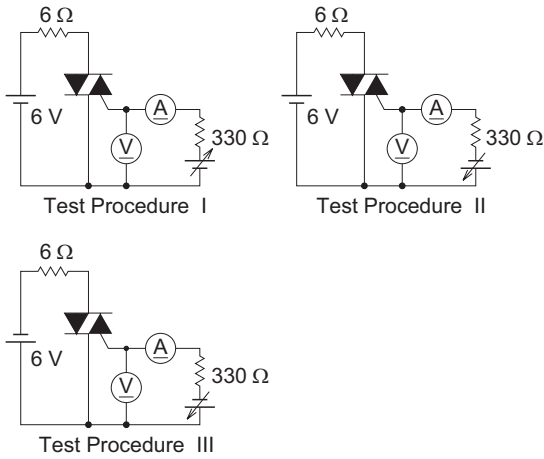

Package Dimensions

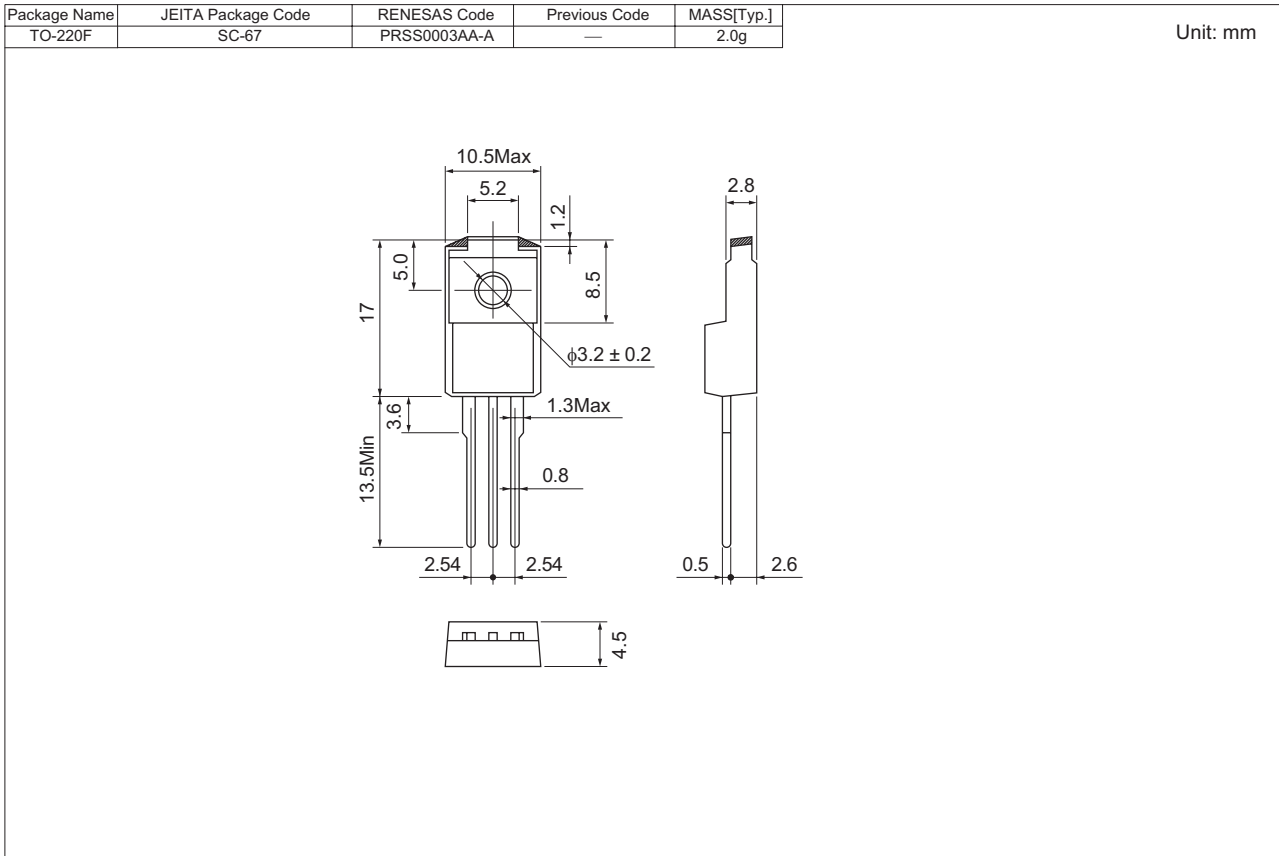

Order Code

Lead form	Standard packing	Quantity	Standard order code	Standard order code example
Straight type	Vinyl sack	100	Type name	BCR5PM-14LD
Lead form	Plastic Magazine (Tube)	50	Type name – Lead forming code	BCR5PM-14LD-A8

Note : Please confirm the specification about the shipping in detail.

Notes:

1. This document is provided for reference purposes only so that Renesas customers may select the appropriate Renesas products for their use. Renesas neither makes warranties or representations with respect to the accuracy or completeness of the information contained in this document nor grants any license to any intellectual property rights or any other rights of Renesas or any third party with respect to the information in this document.
2. Renesas shall have no liability for damages or infringement of any intellectual property or other rights arising out of the use of any information in this document, including, but not limited to, product data, diagrams, charts, programs, algorithms, and application circuit examples.
3. You should not use the products or the technology described in this document for the purpose of military applications such as the development of weapons of mass destruction or for the purpose of any other military use. When exporting the products or technology described herein, you should follow the applicable export control laws and regulations, and procedures required by such laws and regulations.
4. All information included in this document such as product data, diagrams, charts, programs, algorithms, and application circuit examples, is current as of the date this document is issued. Such information, however, is subject to change without any prior notice. Before purchasing or using any Renesas products listed in this document, please confirm the latest product information with a Renesas sales office. Also, please pay regular and careful attention to additional and different information to be disclosed by Renesas such as that disclosed through our website. (<http://www.renesas.com>)
5. Renesas has used reasonable care in compiling the information included in this document, but Renesas assumes no liability whatsoever for any damages incurred as a result of errors or omissions in the information included in this document.
6. When using or otherwise relying on the information in this document, you should evaluate the information in light of the total system before deciding about the applicability of such information to the intended application. Renesas makes no representations, warranties or guarantees regarding the suitability of its products for any particular application and specifically disclaims any liability arising out of the application and use of the information in this document or Renesas products.
7. With the exception of products specified by Renesas as suitable for automobile applications, Renesas products are not designed, manufactured or tested for applications or otherwise in systems the failure or malfunction of which may cause a direct threat to human life or create a risk of human injury or which require especially high quality and reliability such as safety systems, or equipment or systems for transportation and traffic, healthcare, combustion control, aerospace and aeronautics, nuclear power, or undersea communication transmission. If you are considering the use of our products for such purposes, please contact a Renesas sales office beforehand. Renesas shall have no liability for damages arising out of the uses set forth above.
8. Notwithstanding the preceding paragraph, you should not use Renesas products for the purposes listed below:
  - (1) artificial life support devices or systems
  - (2) surgical implantations
  - (3) healthcare intervention (e.g., excision, administration of medication, etc.)
  - (4) any other purposes that pose a direct threat to human lifeRenesas shall have no liability for damages arising out of the uses set forth in the above and purchasers who elect to use Renesas products in any of the foregoing applications shall indemnify and hold harmless Renesas Technology Corp., its affiliated companies and their officers, directors, and employees against any and all damages arising out of such applications.
9. You should use the products described herein within the range specified by Renesas, especially with respect to the maximum rating, operating supply voltage range, movement power voltage range, heat radiation characteristics, installation and other product characteristics. Renesas shall have no liability for malfunctions or damages arising out of the use of Renesas products beyond such specified ranges.
10. Although Renesas endeavors to improve the quality and reliability of its products, IC products have specific characteristics such as the occurrence of failure at a certain rate and malfunctions under certain use conditions. Please be sure to implement safety measures to guard against the possibility of physical injury, and injury or damage caused by fire in the event of the failure of a Renesas product, such as safety design for hardware and software including but not limited to redundancy, fire control and malfunction prevention, appropriate treatment for aging degradation or any other applicable measures. Among others, since the evaluation of microcomputer software alone is very difficult, please evaluate the safety of the final products or system manufactured by you.
11. In case Renesas products listed in this document are detached from the products to which the Renesas products are attached or affixed, the risk of accident such as swallowing by infants and small children is very high. You should implement safety measures so that Renesas products may not be easily detached from your products. Renesas shall have no liability for damages arising out of such detachment.
12. This document may not be reproduced or duplicated, in any form, in whole or in part, without prior written approval from Renesas.
13. Please contact a Renesas sales office if you have any questions regarding the information contained in this document, Renesas semiconductor products, or if you have any other inquiries.



**RENESAS SALES OFFICES**

<http://www.renesas.com>

Refer to "<http://www.renesas.com/en/network>" for the latest and detailed information.

**Renesas Technology America, Inc.**  
450 Holger Way, San Jose, CA 95134-1368, U.S.A  
Tel: <1> (408) 382-7500, Fax: <1> (408) 382-7501

**Renesas Technology Europe Limited**  
Dukes Meadow, Millboard Road, Bourne End, Buckinghamshire, SL8 5FH, U.K.  
Tel: <44> (1628) 585-100, Fax: <44> (1628) 585-900

**Renesas Technology (Shanghai) Co., Ltd.**  
Unit 204, 205, AZIACenter, No.1233 Lujiazui Ring Rd, Pudong District, Shanghai, China 200120  
Tel: <86> (21) 5877-1818, Fax: <86> (21) 6887-7898

**Renesas Technology Hong Kong Ltd.**  
7th Floor, North Tower, World Finance Centre, Harbour City, 1 Canton Road, Tsimshatsui, Kowloon, Hong Kong  
Tel: <852> 2265-6688, Fax: <852> 2730-6071

**Renesas Technology Taiwan Co., Ltd.**  
10th Floor, No.99, Fushing North Road, Taipei, Taiwan  
Tel: <886> (2) 2715-2888, Fax: <886> (2) 2713-2999

**Renesas Technology Singapore Pte. Ltd.**  
1 Harbour Front Avenue, #06-10, Keppel Bay Tower, Singapore 098632  
Tel: <65> 6213-0200, Fax: <65> 6278-8001

**Renesas Technology Korea Co., Ltd.**  
Kukje Center Bldg. 18th Fl., 191, 2-ka, Hangang-ro, Yongsan-ku, Seoul 140-702, Korea  
Tel: <82> (2) 796-3115, Fax: <82> (2) 796-2145

**Renesas Technology Malaysia Sdn. Bhd**  
Unit 906, Block B, Menara Amcorp, Amcorp Trade Centre, No.18, Jalan Persiaran Barat, 46050 Petaling Jaya, Selangor Darul Ehsan, Malaysia  
Tel: <603> 7955-9390, Fax: <603> 7955-9510