

**Thunderbolt IGBT®**

The Thunderbolt IGBT® is a new generation of high voltage power IGBTs. Using Non-Punch-Through Technology, the Thunderbolt IGBT® offers superior ruggedness and ultrafast switching speed.

**Features**

- Low Forward Voltage Drop
- Low Tail Current
- Integrated Gate Resistor
- Low EMI, High Reliability
- RoHS Compliant 
- RBSOA and SCSOA Rated
- High Frequency Switching to 50KHz
- Ultra Low Leakage Current



Unless stated otherwise, Microsemi discrete IGBTs contain a single IGBT die. This device is made with two parallel IGBT die. It is intended for switch-mode operation. It is not suitable for linear mode operation.

**Maximum Ratings**

 All Ratings:  $T_C = 25^\circ C$  unless otherwise specified.

Symbol	Parameter	Ratings	Unit
$V_{CES}$	Collector-Emitter Voltage	1200	Volts
$V_{GE}$	Gate-Emitter Voltage	$\pm 20$	
$I_{C1}$	Continuous Collector Current @ $T_C = 25^\circ C$	123	Amps
$I_{C2}$	Continuous Collector Current @ $T_C = 100^\circ C$	67	
$I_{CM}$	Pulsed Collector Current <sup>①</sup>	200	
SSOA	Switching Safe Operating Area @ $T_J = 150^\circ C$	200A @ 1200V	
$P_D$	Total Power Dissipation	570	Watts
$T_J, T_{STG}$	Operating and Storage Junction Temperature Range	-55 to 150	$^\circ C$
$T_L$	Max. Lead Temp. for Soldering: 0.063" from Case for 10 Sec.	300	

**Static Electrical Characteristics**

Symbol	Characteristic / Test Conditions	Min	Typ	Max	Unit
$V_{(BR)CES}$	Collector-Emitter Breakdown Voltage ( $V_{GE} = 0V, I_C = 5mA$ )	1200	-	-	Volts
$V_{GE(TH)}$	Gate Threshold Voltage ( $V_{CE} = V_{GE}, I_C = 4mA, T_J = 25^\circ C$ )	4.5	5.5	6.5	
$V_{CE(ON)}$	Collector Emitter On Voltage ( $V_{GE} = 15V, I_C = 100A, T_J = 25^\circ C$ )	2.7	3.2	3.7	
	Collector Emitter On Voltage ( $V_{GE} = 15V, I_C = 100A, T_J = 125^\circ C$ )	-	4.0	-	
$I_{CES}$	Collector Cut-off Current ( $V_{CE} = 1200V, V_{GE} = 0V, T_J = 25^\circ C$ ) <sup>②</sup>	-	-	200	$\mu A$
	Collector Cut-off Current ( $V_{CE} = 1200V, V_{GE} = 0V, T_J = 125^\circ C$ ) <sup>②</sup>	-	-	TBD	
$I_{GES}$	Gate-Emitter Leakage Current ( $V_{GE} = \pm 20V$ )	-	-	600	nA
$R_{G(int)}$	Integrated Gate Resistor	-	5	-	$\Omega$

 CAUTION: These Devices are Sensitive to Electrostatic Discharge. Proper Handling Procedures Should Be Followed.

## Dynamic Characteristic

APT100GT120JRDQ4

Symbol	Characteristic	Test Conditions	Min	Typ	Max	Unit
$C_{ies}$	Input Capacitance	$V_{GE} = 0V, V_{CE} = 25V$ $f = 1MHz$	-	7850	-	pF
$C_{oes}$	Output Capacitance		-	650	-	
$C_{res}$	Reverse Transfer Capacitance		-	275	-	
$V_{GEP}$	Gate-to-Emitter Plateau Voltage	Gate Charge $V_{GE} = 15V$ $V_{CE} = 600V$ $I_C = 100A$	-	10.0	-	V
$Q_g$	Total Gate Charge		-	685	-	nC
$Q_{ge}$	Gate-Emitter Charge		-	75	-	
$Q_{gc}$	Gate-Collector Charge		-	400	-	
SSOA	Switching Safe Operating Area	$T_J = 150^\circ C, R_G = 1.0\Omega^{(2)}, V_{GE} = 15V,$ $L = 100\mu H, V_{CE} = 1200V$	150			A
$t_{d(on)}$	Turn-On Delay Time	Inductive Switching (25°C) $V_{CC} = 800V$ $V_{GE} = 15V$ $I_C = 100A$ $R_G = 4.7\Omega$ $T_J = +25^\circ C$	-	50	-	ns
$t_r$	Current Rise Time		-	100	-	
$t_{d(off)}$	Turn-Off Delay Time		-	630	-	
$t_f$	Current Fall Time		-	36	-	μJ
$E_{on1}$	Turn-On Switching Energy <sup>(4)</sup>		-	TBD	-	
$E_{on2}$	Turn-On Switching Energy <sup>(5)</sup>		-	17600	-	
$E_{off}$	Turn-Off Switching Energy <sup>(6)</sup>	-	7240	-		
$t_{d(on)}$	Turn-On Delay Time	Inductive Switching (125°C) $V_{CC} = 800V$ $V_{GE} = 15V$ $I_C = 100A$ $R_G = 4.7\Omega$ $T_J = 125^\circ C$	-	50	-	ns
$t_r$	Current Rise Time		-	100	-	
$t_{d(off)}$	Turn-Off Delay Time		-	710	-	
$t_f$	Current Fall Time		-	37	-	μJ
$E_{on1}$	Turn-On Switching Energy <sup>(4)</sup>		-	TBD	-	
$E_{on2}$	Turn-On Switching Energy <sup>(5)</sup>		-	22380	-	
$E_{off}$	Turn-Off Switching Energy <sup>(6)</sup>	-	10950	-		

## Thermal and Mechanical Characteristics

Symbol	Characteristic / Test Conditions	Min	Typ	Max	Unit
$R_{\theta JC}$	Junction to Case (IGBT)	-	-	0.22	°C/W
$R_{\theta JC}$	Junction to Case (DIODE)	-	-	0.56	
$W_T$	Package Weight	-	29.2	-	g
$V_{isolation}$	RMS Voltage (50-60Hz Sinusoidal Waveform from Terminals to Mounting Base for 1 Min.)	2500	-	-	Volts

① Repetitive Rating: Pulse width limited by maximum junction temperature.

② For Combi devices,  $I_{ces}$  includes both IGBT and FRED leakages.

③ See MIL-STD-750 Method 3471.

④  $E_{on1}$  is the clamped inductive turn-on energy of the IGBT only, without the effect of a commutating diode reverse recovery current adding to the IGBT turn-on loss. Tested in inductive switching test circuit shown in figure 21, but with a Silicon Carbide diode.

⑤  $E_{on2}$  is the clamped inductive turn-on energy that includes a commutating diode reverse recovery current in the IGBT turn-on switching loss. (See Figures 21, 22.)

⑥  $E_{off}$  is the clamped inductive turn-off energy measured in accordance with JEDEC standard JESD24-1. (See Figures 21, 23.)

⑦  $R_G$  is external gate resistance not including gate driver impedance.

Microsemi reserves the right to change, without notice, the specifications and information contained herein.

# Typical Performance Curves

APT100GT120JRDQ4

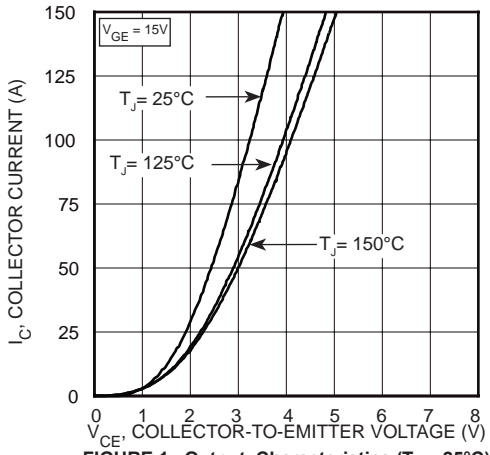

FIGURE 1, Output Characteristics ( $T_J = 25^\circ\text{C}$ )

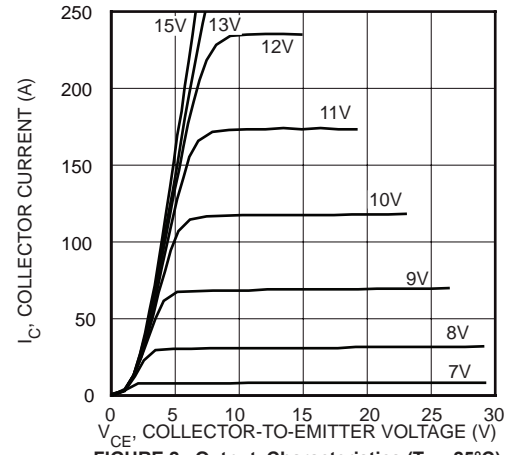

FIGURE 2, Output Characteristics ( $T_J = 25^\circ\text{C}$ )

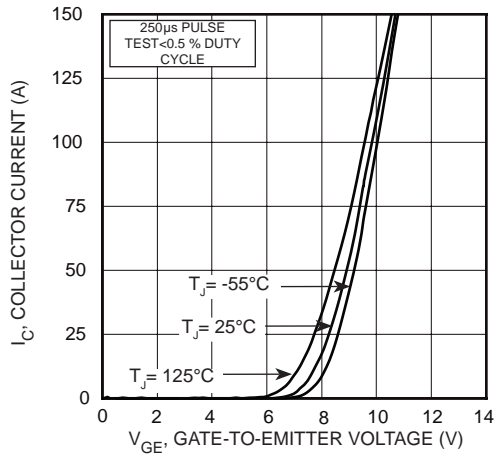

FIGURE 3, Transfer Characteristics

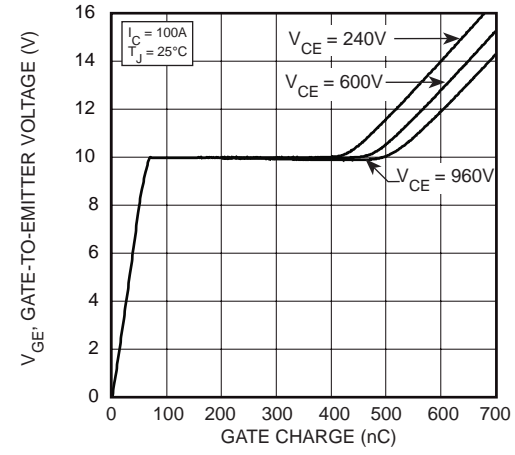

FIGURE 4, Gate charge

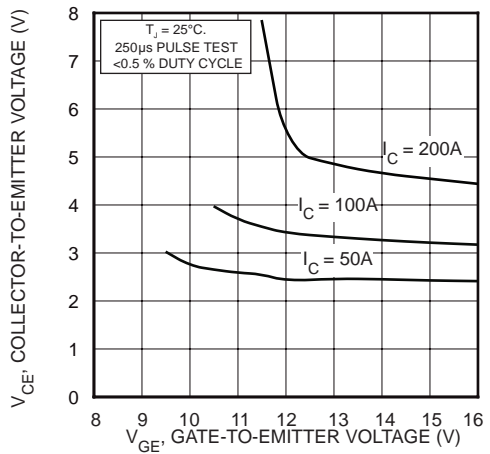

FIGURE 5, On State Voltage vs Gate-to-Emitter Voltage

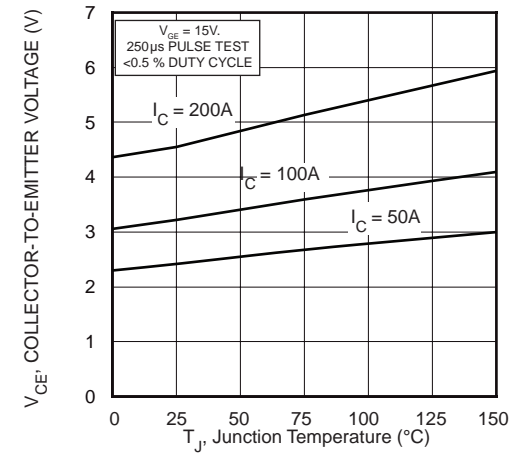

FIGURE 6, On State Voltage vs Junction Temperature

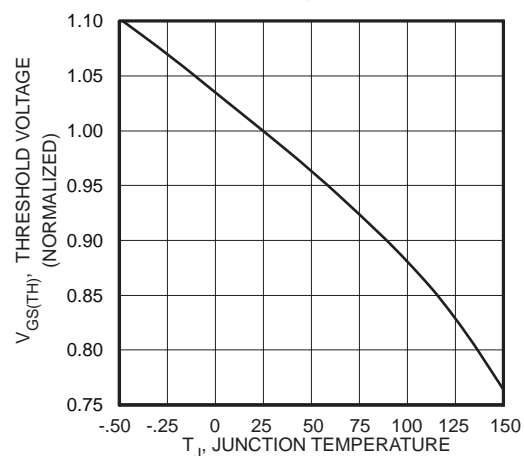

FIGURE 7, Threshold Voltage vs Junction Temperature

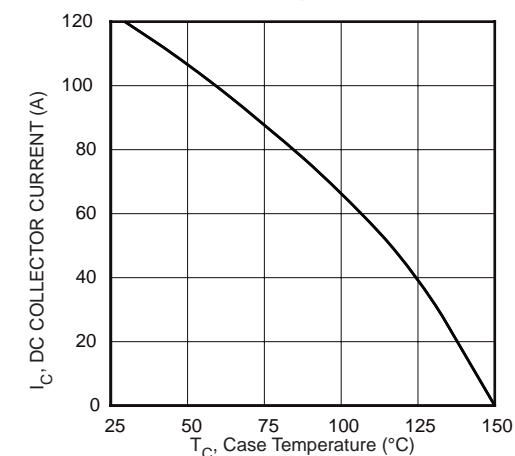

FIGURE 8, DC Collector Current vs Case Temperature

# Typical Performance Curves

APT100GT120JRDQ4

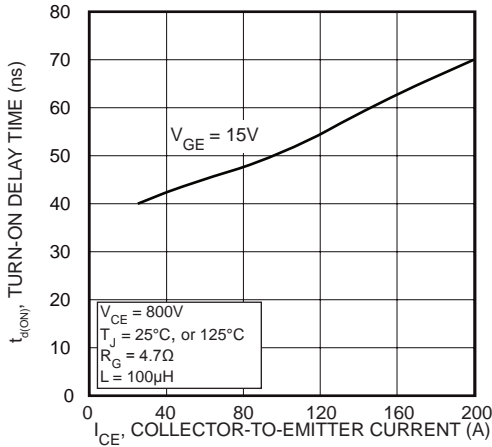

FIGURE 9, Turn-On Delay Time vs Collector Current

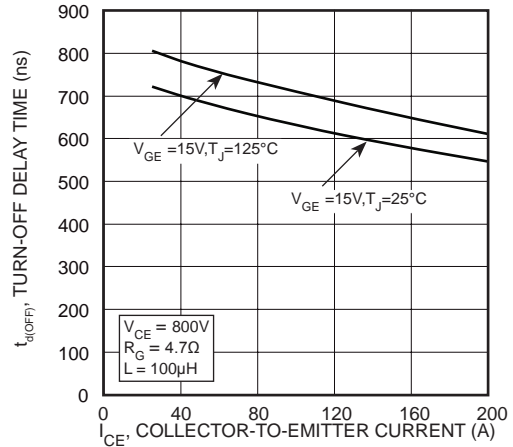

FIGURE 10, Turn-Off Delay Time vs Collector Current

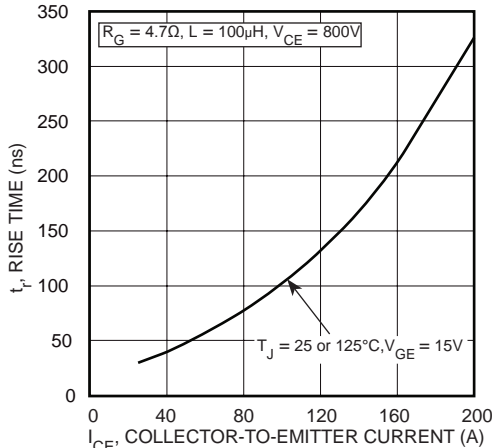

FIGURE 11, Current Rise Time vs Collector Current

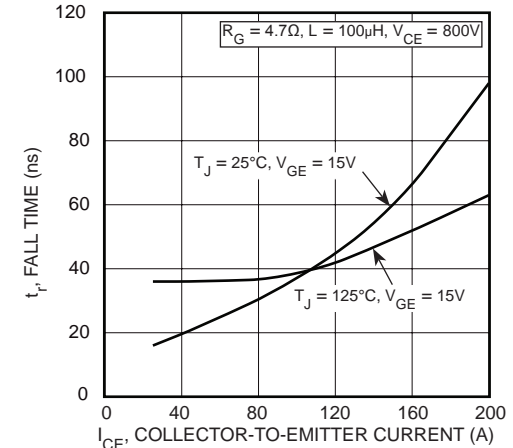

FIGURE 12, Current Fall Time vs Collector Current

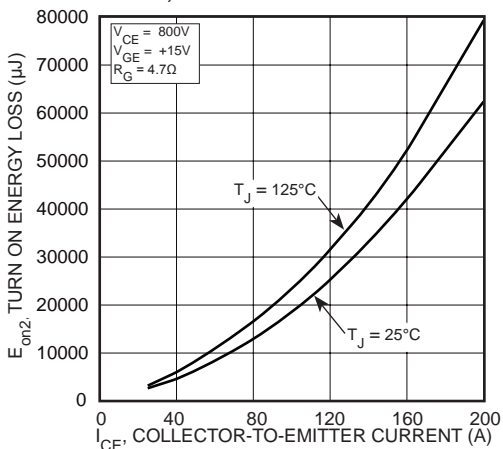

FIGURE 13, Turn-On Energy Loss vs Collector Current

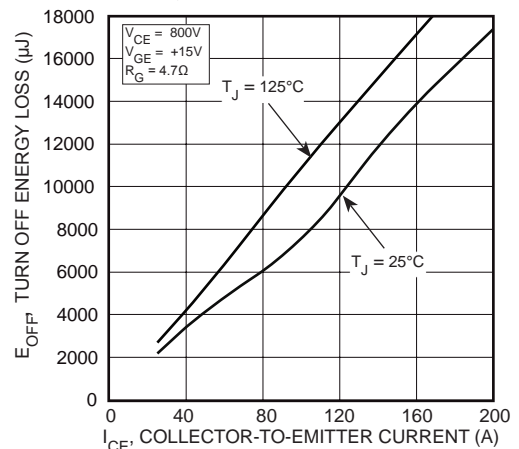

FIGURE 14, Turn-Off Energy Loss vs Collector Current

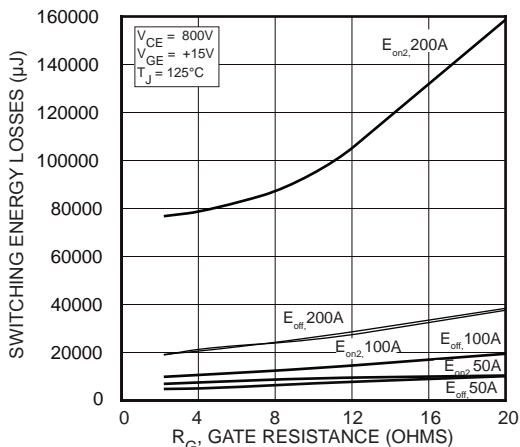

FIGURE 15, Switching Energy Losses vs Gate Resistance

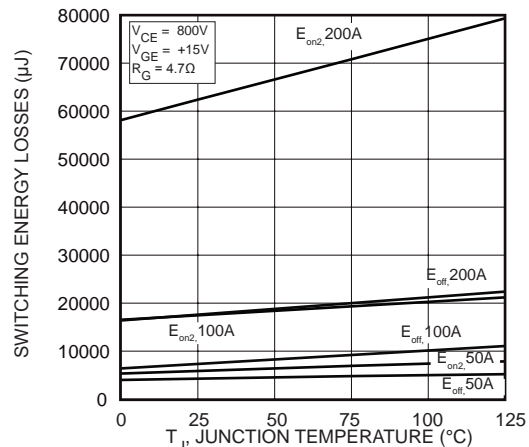
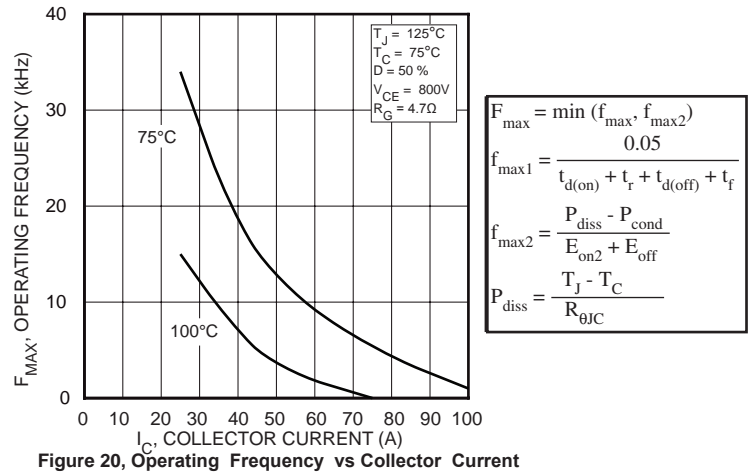
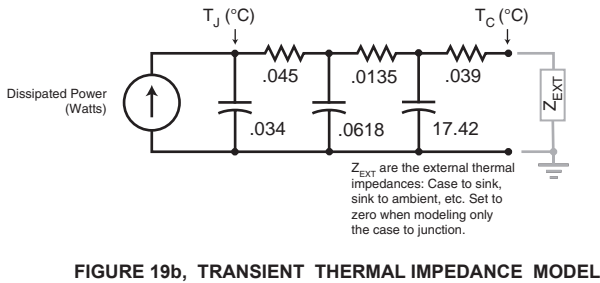
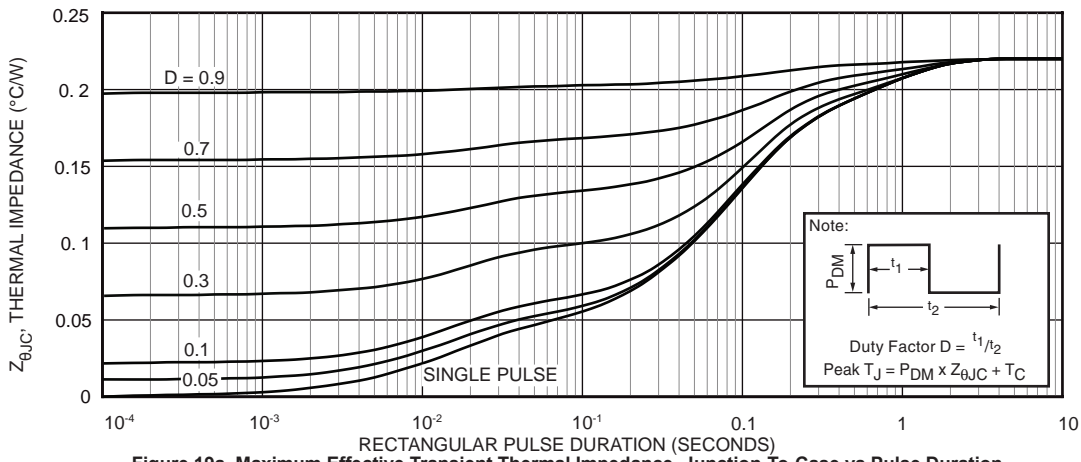
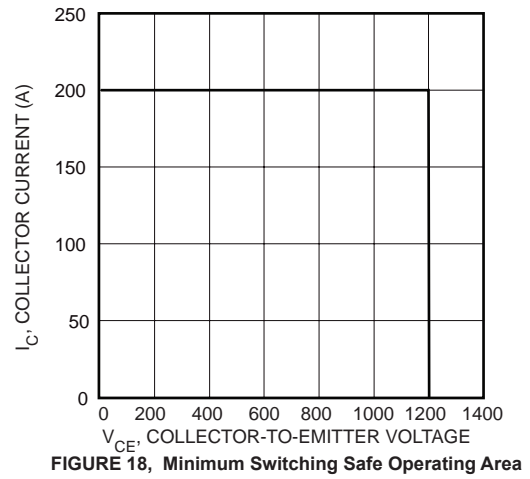
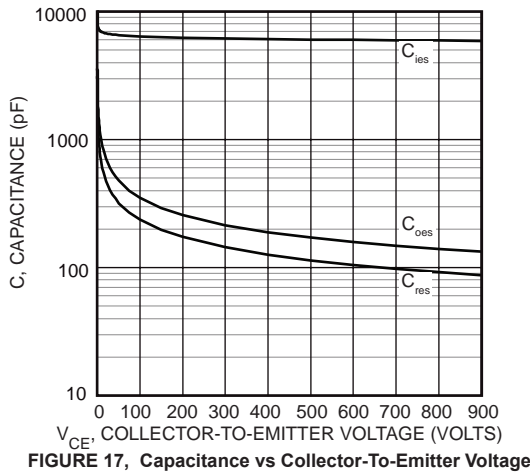

FIGURE 16, Switching Energy Losses vs Junction Temperature

Typical Performance Curves

APT100GT120JRDQ4



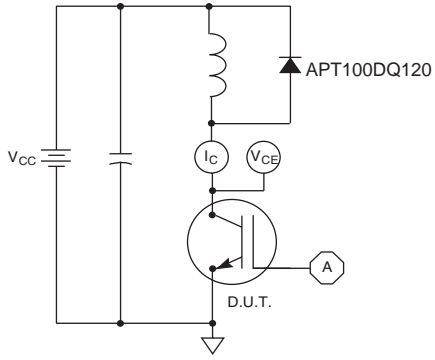

Figure 21, Inductive Switching Test Circuit

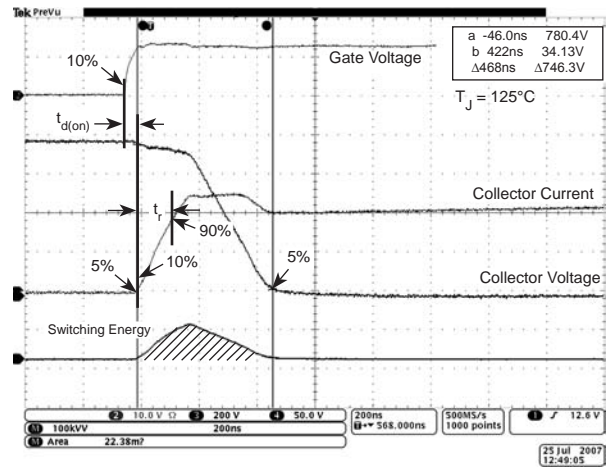

Figure 22, Turn-on Switching Waveforms and Definitions

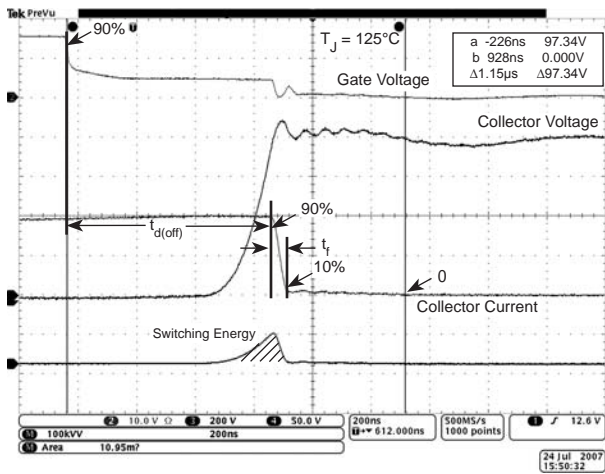

Figure 23, Turn-off Switching Waveforms and Definitions

**ULTRAFAST SOFT RECOVERY ANTI-PARALLEL DIODE**

**MAXIMUM RATINGS**

All Ratings:  $T_C = 25^\circ\text{C}$  unless otherwise specified.

Symbol	Characteristic / Test Conditions	APT100GT120JRDQ4	Unit
$I_{F(AV)}$	Maximum Average Forward Current ( $T_C = 88^\circ\text{C}$ , Duty Cycle = 0.5)	60	Amps
$I_{F(RMS)}$	RMS Forward Current (Square wave, 50% duty)	73	
$I_{FSM}$	Non-Repetitive Forward Surge Current ( $T_J = 45^\circ\text{C}$ , 8.3 ms)	540	

**STATIC ELECTRICAL CHARACTERISTICS**

Symbol	Characteristic / Test Conditions	Min	Type	Max	Unit
$V_F$	Forward Voltage		$I_F = 75\text{A}$	2.8	Volts
			$I_F = 150\text{A}$	3.48	
			$I_F = 75\text{A}, T_J = 125^\circ\text{C}$	2.17	

**DYNAMIC CHARACTERISTICS**

Symbol	Characteristic	Test Conditions	Min	Typ	Max	Unit
$t_{rr}$	Reverse Recovery Time	$I_F = 1\text{A}, di_F/dt = -100\text{A}/\mu\text{s}, V_R = 30\text{V}, T_J = 25^\circ\text{C}$	-	60	-	ns
$t_{rr}$	Reverse Recovery Time	$I_F = 60\text{A}, di_F/dt = -200\text{A}/\mu\text{s}, V_R = 800\text{V}, T_C = 25^\circ\text{C}$	-	265	-	ns
$Q_{rr}$	Reverse Recovery Charge		-	560	-	nC
$I_{RRM}$	Maximum Reverse Recovery Current		-	5	-	Amps
$t_{rr}$	Reverse Recovery Time	$I_F = 60\text{A}, di_F/dt = -200\text{A}/\mu\text{s}, V_R = 800\text{V}, T_C = 125^\circ\text{C}$	-	350	-	ns
$Q_{rr}$	Reverse Recovery Charge		-	2890	-	nC
$I_{RRM}$	Maximum Reverse Recovery Current		-	13	-	Amps
$t_{rr}$	Reverse Recovery Time	$I_F = 60\text{A}, di_F/dt = -1000\text{A}/\mu\text{s}, V_R = 800\text{V}, T_C = 125^\circ\text{C}$	-	150	-	ns
$Q_{rr}$	Reverse Recovery Charge		-	4720	-	nC
$I_{RRM}$	Maximum Reverse Recovery Current		-	40	-	Amps

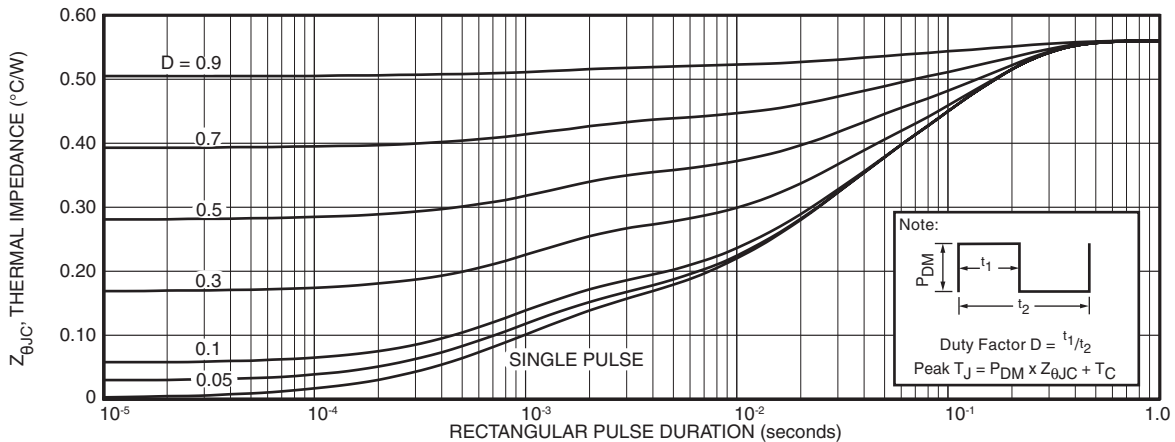

FIGURE 24a. MAXIMUM EFFECTIVE TRANSIENT THERMAL IMPEDANCE, JUNCTION-TO-CASE vs. PULSE DURATION

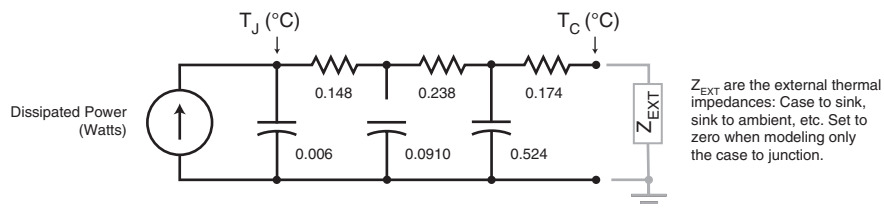

FIGURE 24b. TRANSIENT THERMAL IMPEDANCE MODEL

# Typical Performance Curves

APT100GT120JRDQ4

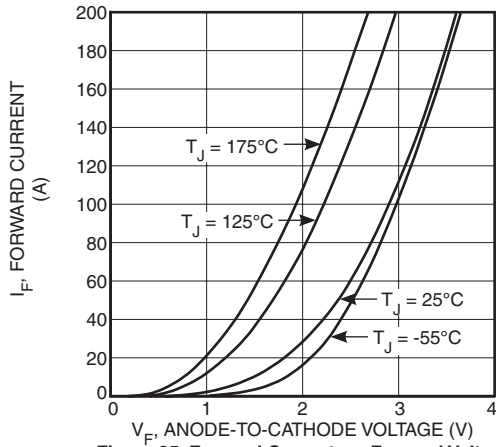

Figure 25. Forward Current vs. Forward Voltage

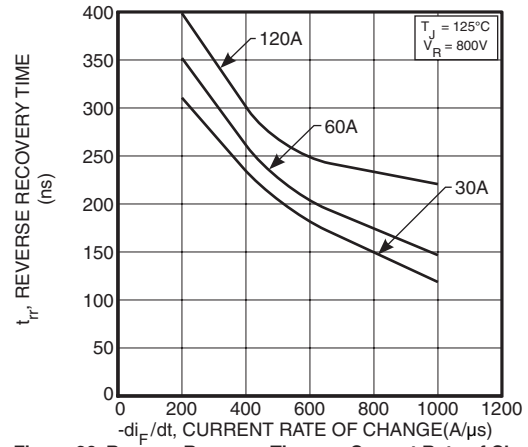

Figure 26. Reverse Recovery Time vs. Current Rate of Change

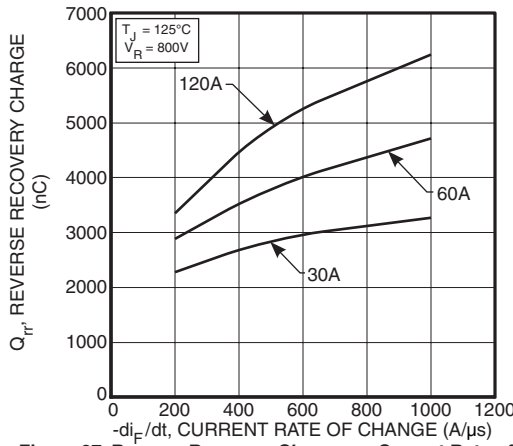

Figure 27. Reverse Recovery Charge vs. Current Rate of Change

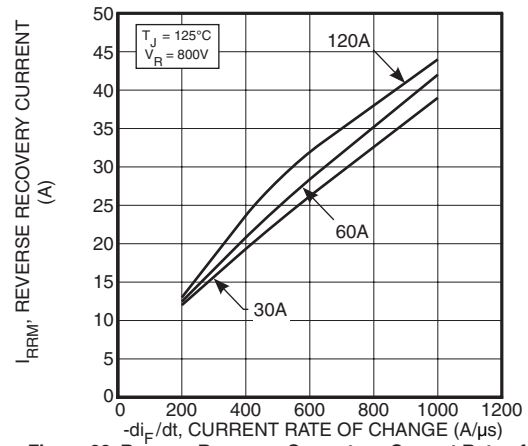

Figure 28. Reverse Recovery Current vs. Current Rate of Change

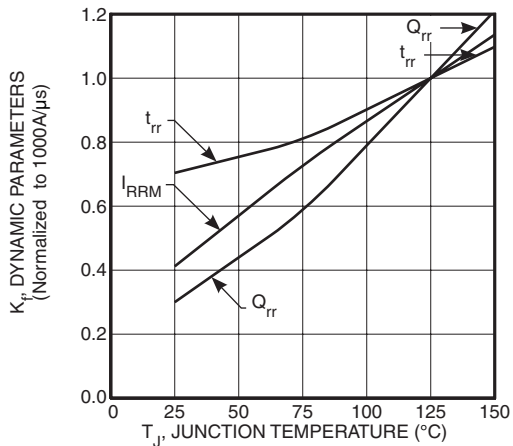

Figure 29. Dynamic Parameters vs. Junction Temperature

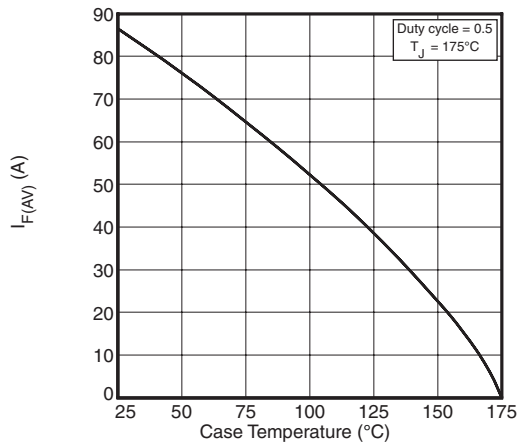

Figure 30. Maximum Average Forward Current vs. Case Temperature

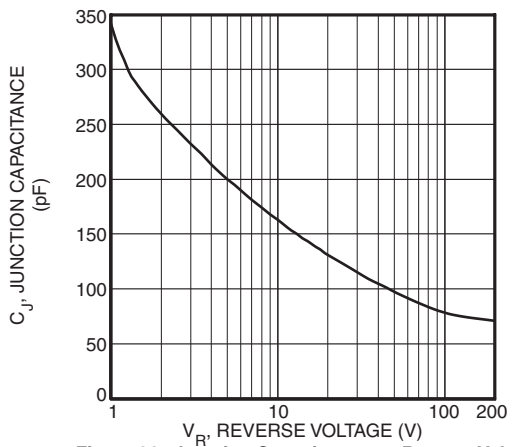

Figure 31. Junction Capacitance vs. Reverse Voltage



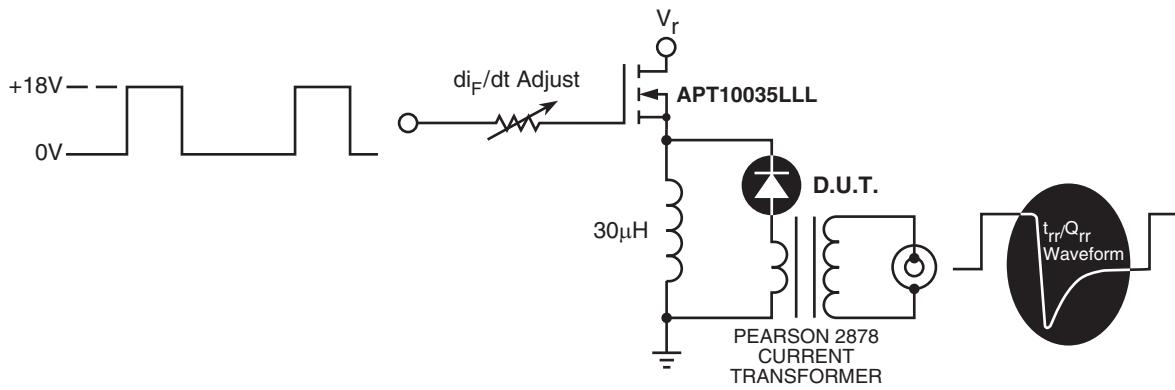

Figure 32, Diode Test Circuit

- 1  $I_F$  - Forward Conduction Current
- 2  $di_F/dt$  - Rate of Diode Current Change Through Zero Crossing.
- 3  $I_{RRM}$  - Maximum Reverse Recovery Current.
- 4  $t_{rr}$  - Reverse Recovery Time, measured from zero crossing where diode current goes from positive to negative, to the point at which the straight line through  $I_{RRM}$  and  $0.25 \cdot I_{RRM}$  passes through zero.
- 5  $Q_{rr}$  - Area Under the Curve Defined by  $I_{RRM}$  and  $t_{rr}$ .

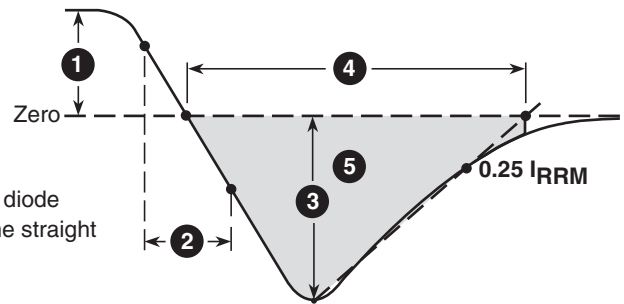
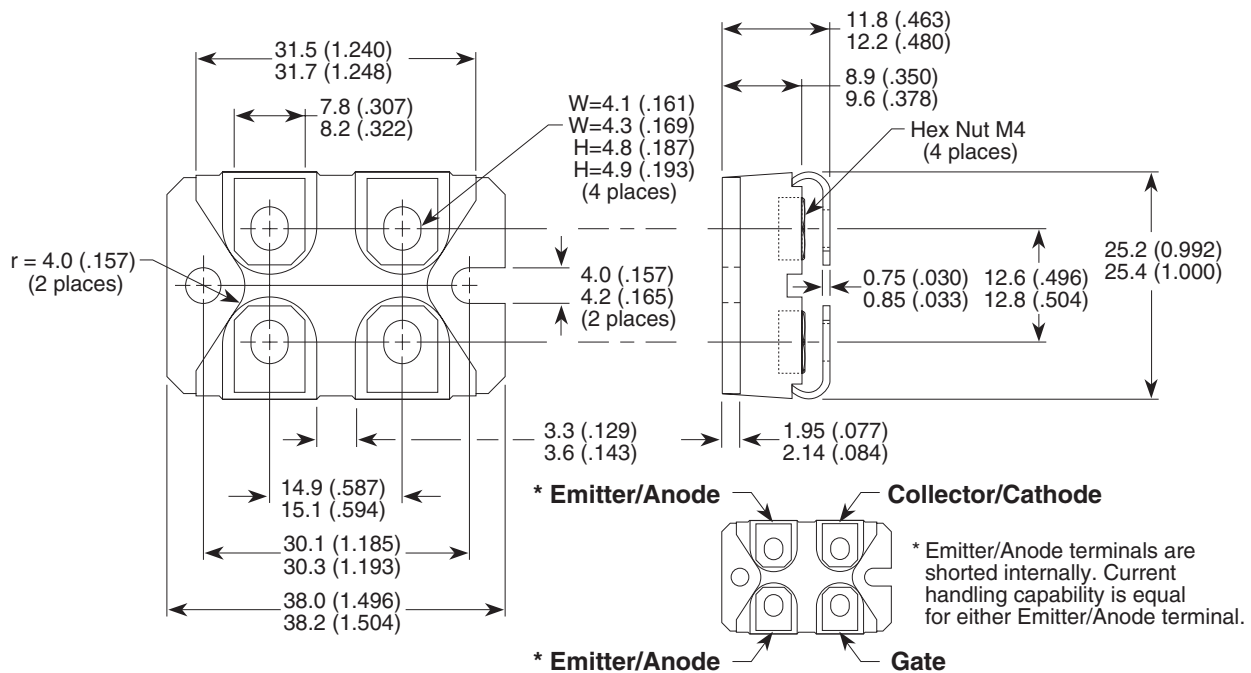

Figure 33, Diode Reverse Recovery Waveform and Definitions

SOT-227 (ISOTOP®) Package Outline



Dimensions in Millimeters and (Inches)