

IGBT Module

Preliminary Data Sheet

PSII 75/12*

$$\begin{aligned} I_{C80} &= 60 \text{ A} \\ V_{CES} &= 1200 \text{ V} \\ V_{CE(sat)typ.} &= 2.7 \text{ V} \end{aligned}$$

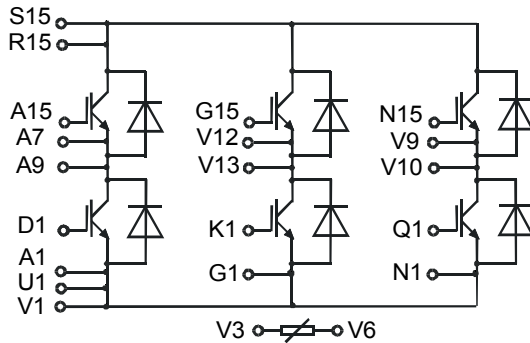

ECO-TOP™ 1

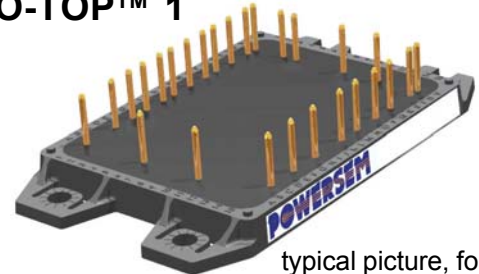

typical picture, for pin configuration see outline drawing

IGBTs

Symbol	Conditions	Maximum Ratings
V_{CES}	$T_{VJ} = 25^{\circ}\text{C to } 150^{\circ}\text{C}$	1200 V
V_{GES}		± 20 V
I_{C25}	$T_C = 25^{\circ}\text{C}$	90 A
I_{C80}	$T_C = 80^{\circ}\text{C}$	60 A
I_{CM} V_{CEK}	$V_{GE} = \pm 15 \text{ V}; R_G = 22 \Omega; T_{VJ} = 125^{\circ}\text{C}$ RBSOA, Clamped inductive load; $L = 100 \mu\text{H}$	100 A V_{CES}
t_{SC} (SCSOA)	$V_{CE} = V_{CES}; V_{GE} = \pm 15 \text{ V}; R_G = 22 \Omega; T_{VJ} = 125^{\circ}\text{C}$ non-repetitive	10 μs
P_{tot}	$T_C = 25^{\circ}\text{C}$	379 W

*NTC optional

Symbol	Conditions	Characteristic Values		
		(T _{VJ} = 25°C, unless otherwise specified)		
		min.	typ.	max.
$V_{CE(sat)}$	$I_C = 75 \text{ A}; V_{GE} = 15 \text{ V}; T_{VJ} = 25^{\circ}\text{C}$ $T_{VJ} = 125^{\circ}\text{C}$	2.7	3.0	3.2 V V
$V_{GE(th)}$	$I_C = 2 \text{ mA}; V_{GE} = V_{CE}$	4.5		6.5 V
I_{CES}	$V_{CE} = V_{CES}; V_{GE} = 0 \text{ V}; T_{VJ} = 25^{\circ}\text{C}$ $T_{VJ} = 125^{\circ}\text{C}$			3.7 mA 12.5 mA
I_{GES}	$V_{CE} = 0 \text{ V}; V_{GE} = \pm 20 \text{ V}$			200 nA
$t_{d(on)}$ t_r $t_{d(off)}$ t_f E_{on} E_{off}	Inductive load, $T_{VJ} = 125^{\circ}\text{C}$ $V_{CE} = 600 \text{ V}; I_C = 60 \text{ A}$ $V_{GE} = 15/0 \text{ V}; R_G = 22 \Omega$		100	ns
			70	ns
			500	ns
			70	ns
			9.1	mJ
			6.7	mJ
C_{ies}	$V_{CE} = 25 \text{ V}; V_{GE} = 0 \text{ V}; f = 1 \text{ MHz}$		3.3	nF
R_{thJC} R_{thJH}	(per IGBT) with heatsink compound (0.42 K/m.K; 50 μm)		0.66	0.33 K/W K/W

Features

- Package with DCB ceramic base plate
- Isolation voltage 3000 V~
- Planar glass passivated chips
- Low forward voltage drop
- Leads suitable for PC board soldering
- UL Release applied

Applications

- AC and DC motor control
- AC servo and robot drives
- Power supplies
- Welding inverters

Advantages

- Easy to mount with four screws
- Space and weight savings
- Improved temperature and power cycling capability
- High power density
- Small and light weight

Caution: These Devices are sensitive to electrostatic discharge. Users should observe proper ESD handling precautions.

Reverse diodes (FRED)

Symbol	Conditions	Maximum Ratings	
I_{F25}	$T_C = 25^\circ\text{C}$	100	A
I_{F80}	$T_C = 80^\circ\text{C}$	60	A

Symbol	Conditions	Characteristic Values		
		min.	typ.	max.
V_F	$I_F = 60\text{ A}; T_{VJ} = 25^\circ\text{C}$ $T_{VJ} = 125^\circ\text{C}$	2.28	2.6	V
		1.67		V
I_{RM}	$I_F = 60\text{ A}; di_F/dt = 500\text{ A}/\mu\text{s}; T_{VJ} = 125^\circ\text{C}$ $V_R = 600\text{ V}; V_{GE} = 0\text{ V}$	41		A
t_{tr}		200		ns
R_{thJC}	with heatsink compound (0.42 K/m.K; 50 μm)		0.66	K/W
R_{thJH}		1.32		K/W

Temperature Sensor NTC

Symbol	Conditions	Characteristic Values		
		min.	typ.	max.
R_{25}	$T = 25^\circ\text{C}$	4.75	5.0	5.25 k Ω
$B_{25/50}$			3375	K

Module

Symbol	Conditions	Maximum Ratings	
T_{VJ}		-40...+125	$^\circ\text{C}$
T_{stg}		-40...+150	$^\circ\text{C}$
V_{ISOL}	$I_{ISOL} \leq 1\text{ mA}; 50/60\text{ Hz}$	3000	V~
M_d	Mounting torque (M5)	3	Nm
		26	lb.in.
a	Max. allowable acceleration	50	m/s^2

Symbol	Conditions	Characteristic Values		
		min.	typ.	max.
d_s	Creepage distance on surface (Pin to heatsink)	11.2		mm
d_A	Strike distance in air (Pin to heatsink)	11.2		mm
Weight		86		g

Package style and outline

Dimensions in mm (1mm = 0.0394")

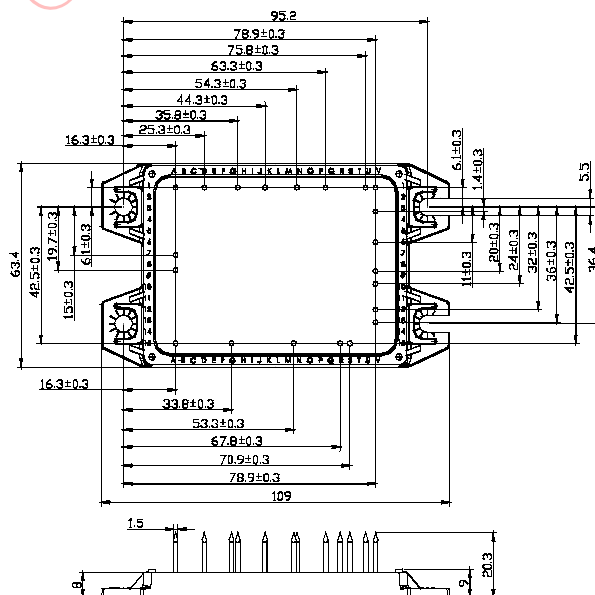

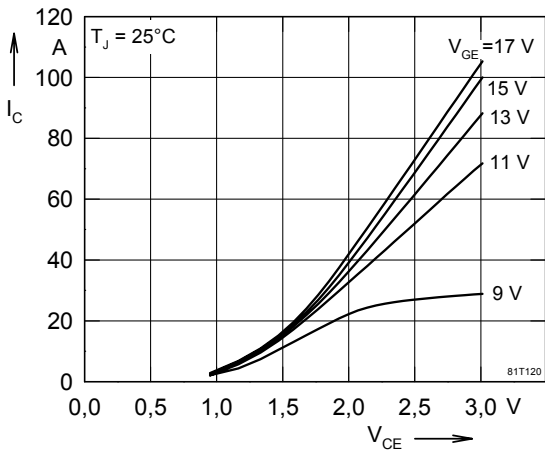

Fig. 1 Typ. output characteristics

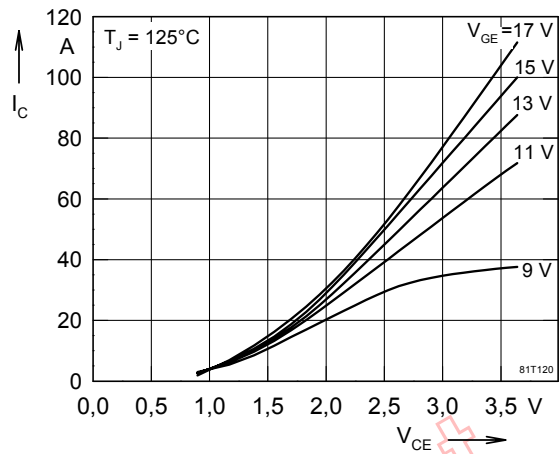

Fig. 2 Typ. output characteristics

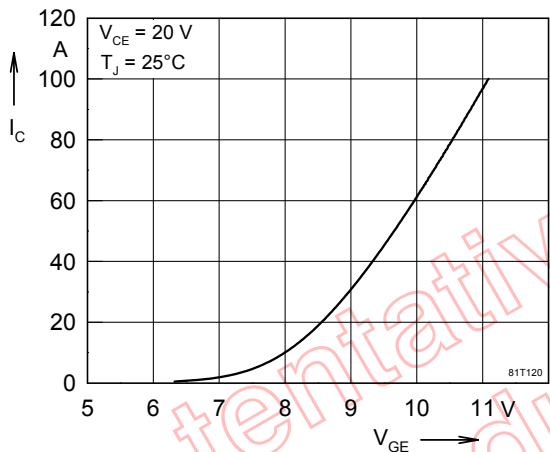

Fig. 3 Typ. transfer characteristics

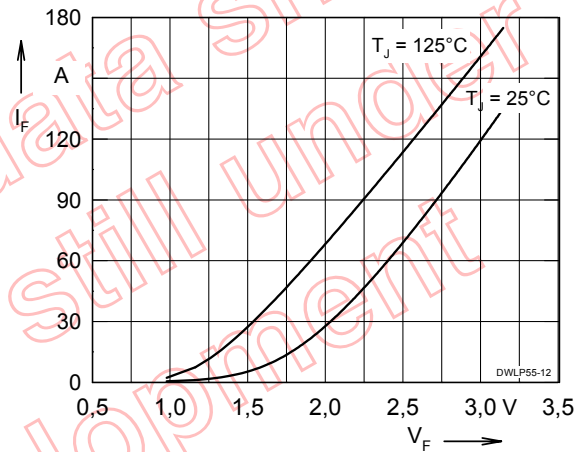

Fig. 4 Typ. forward characteristics of free wheeling diode

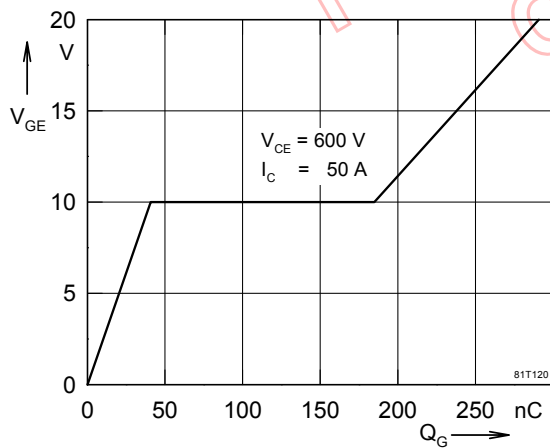

Fig. 5 Typ. turn on gate charge

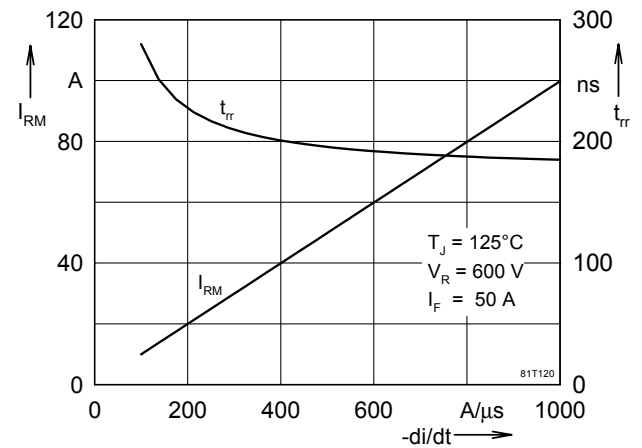

Fig. 6 Typ. turn off characteristics of free wheeling diode

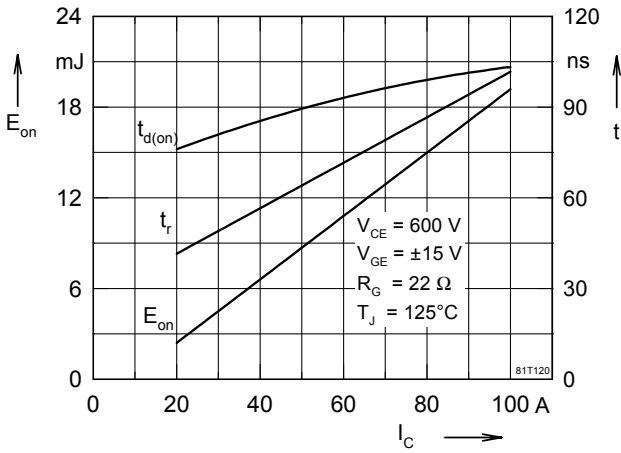

Fig. 7 Typ. turn on energy and switching

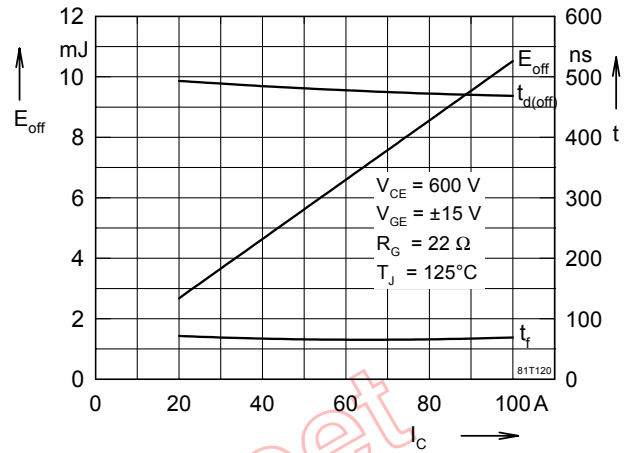

Fig. 8 Typ. turn off energy and switching times versus collector current times versus collector current

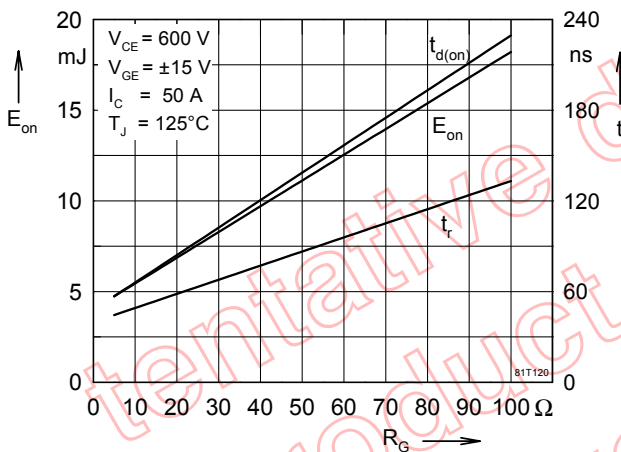

Fig. 9 Typ. turn on energy and switching

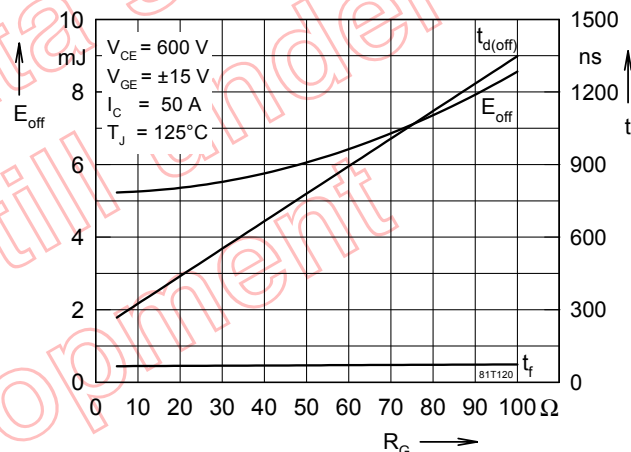

Fig. 10 Typ. turn off energy and switching times versus gate resistor times versus gate resistor

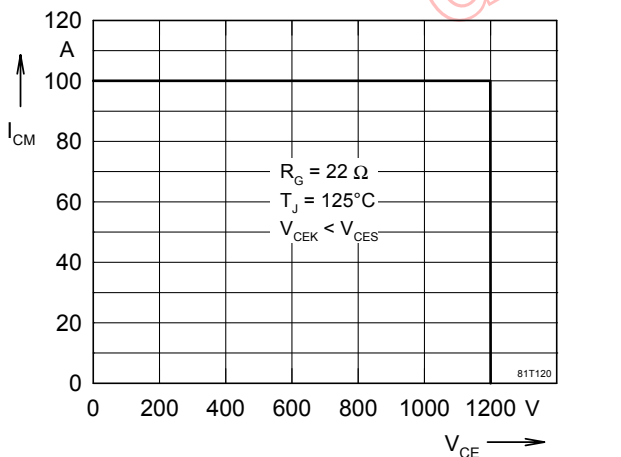

Fig. 11 Reverse biased safe operating area

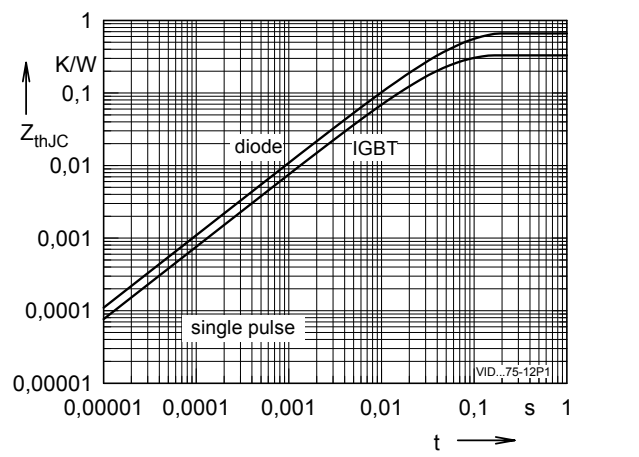

Fig. 12 Typ. transient thermal impedance RBSOA