



## N-Channel Enhancement Mode Field Effect Transistor

### General Description

These products have been designed to minimize on-state resistance While provide rugged, reliable, and fast switching performance. These products are particularly suited for low voltage, low current applications such as small servo motor control, power MOSFET gate drivers, and other switching applications.

### Features

- High density cell design for low  $R_{ds(on)}$ .
- Voltage controlled small signal switch.
- Rugged and reliable.
- High saturation current capability.

### Maximum Ratings ( $T_a=25$ unless otherwise specified )

$T_{stg}$	Storage Temperature	-----	-55~150
$T_j$	Operating Junction Temperature	-----	-55~150
$V_{DSS}$	Drain-Source Voltage	-----	60V
$V_{DGR}$	Drain-Gate Voltage ( $R_{GS} = 1M$ )	-----	60V
$V_{GSS}$	Gate-Source Voltage	-----	$\pm 20V$
$I_D$	Drain Current (Continuous)	-----	200mA
$P_D$	Maximum Power Dissipation	-----	400mW

### Electrical Characteristics ( $T_a=25$ unless otherwise specified )

Symbol	Items	Min.	Typ.	Max.	Unit	Conditions
$BV_{DSS}$	Drain-Source Breakdown Voltage	60			V	$V_{GS}=0V, I_D=10\mu A$
$I_{DSS}$	Zero Gate Voltage Drain Current			1	$\mu A$	$V_{DS}=48V, V_{GS}=0V$
$I_{GSS}$	Gate - Body Leakage, Forward			$\pm 10$	nA	$V_{GS}=\pm 15V, V_{DS}=0V$
$V_{GS(TH)}$	Gate Threshold Voltage	0.8		3.0	V	$V_{DS}=V_{GS}, I_D=1mA$
$R_{DS(ON)}$	Static Drain-Source On-Resistance			5	$\Omega$	$V_{GS}=10V, I_D=500mA$
				5.3	$\Omega$	$V_{GS}=4.5V, I_D=75mA$
$V_{DS(ON)}$	Drain-Source On-Voltage			2.5	V	$V_{GS}=10V, I_D=500mA$
				0.4	V	$V_{GS}=4.5V, I_D=75mA$
$I_{D(ON)}$	On-State Drain Current	75			mA	$V_{GS}=4.5V, V_{DS}=10V$
$g_{FS}$	Forward Transconductance		320		mS	$V_{DS}=10V, I_D=200mA$
$C_{iss}$	Input Capacitance		20	50	pF	$V_{DS}=25V, V_{GS}=0V,$ $f=1.0MHz$
$C_{oss}$	Output Capacitance		11	25	pF	
$C_{rSS}$	Reverse Transfer Capacitance		4	5	pF	
$t_{on}$	Turn - On Time			10	nS	$V_{DD}=15V, R_L=25\Omega, I_D=500mA,$ $V_{GS}=10V, R_{GEN}=25\Omega$
$t_{off}$	Turn - Off Time			10	nS	

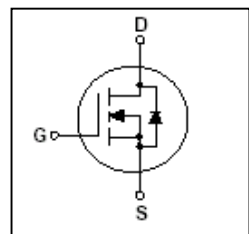
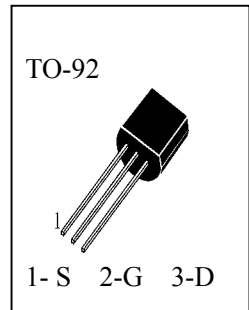



## Performance Curves

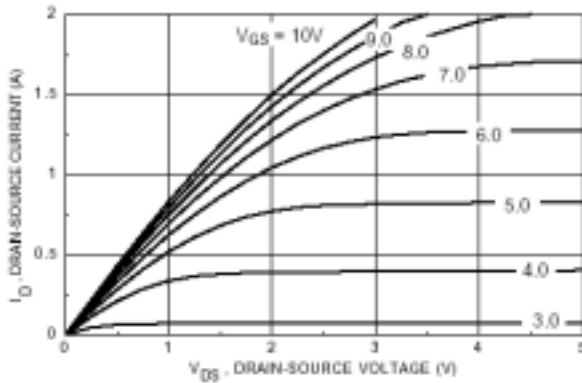

Figure 1. On-Region Characteristics.

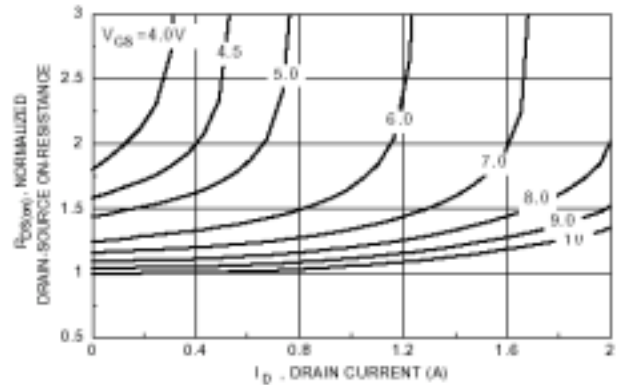

Figure 2. On-Resistance Variation with Gate Voltage and Drain Current.

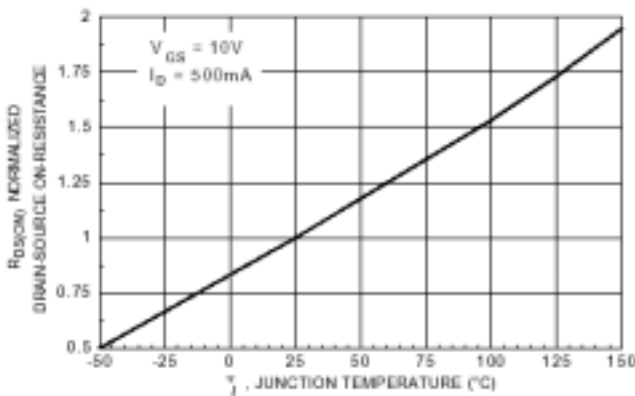

Figure 3. On-Resistance Variation with Temperature.

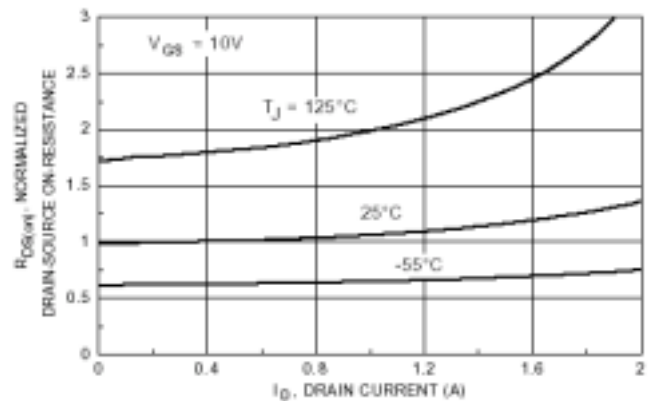

Figure 4. On-Resistance Variation with Drain Current and Temperature.

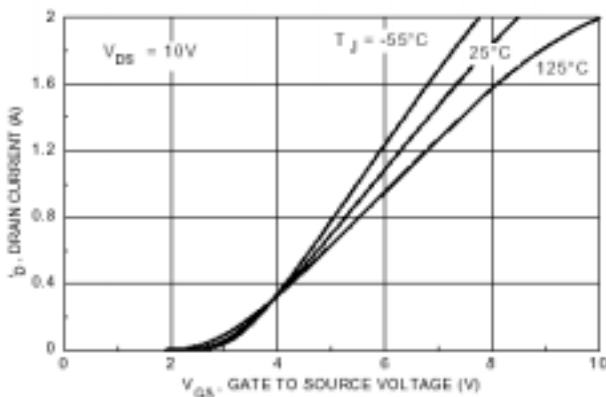

Figure 5. Transfer Characteristics.

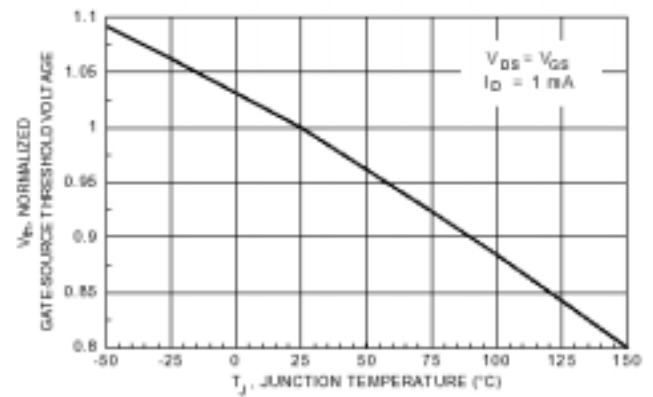

Figure 6. Gate Threshold Variation with Temperature.



## Performance Curves

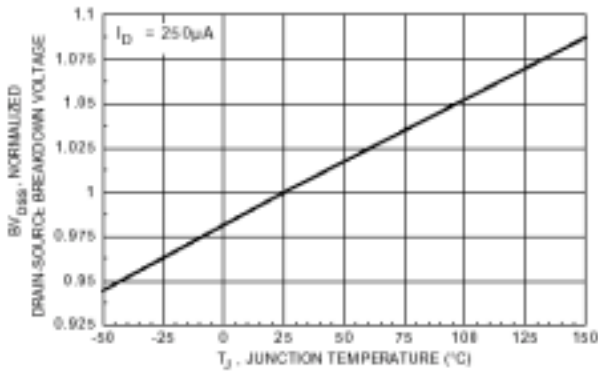

Figure 7. Breakdown Voltage Variation with Temperature

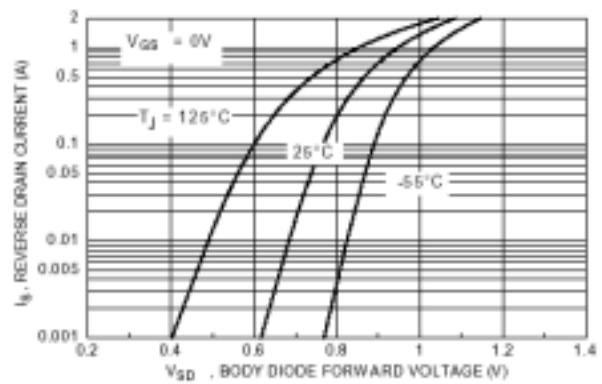

Figure 8. Body Diode Forward Voltage Variation with Temperature

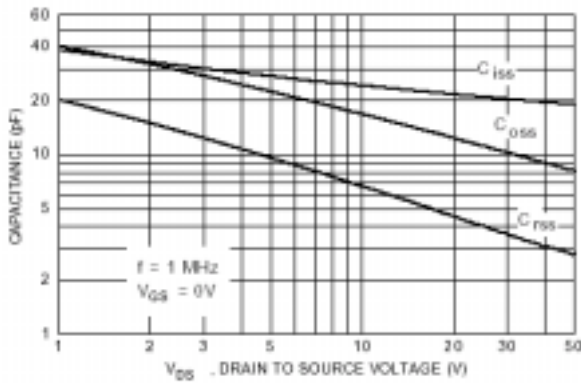

Figure 9. Capacitance Characteristics

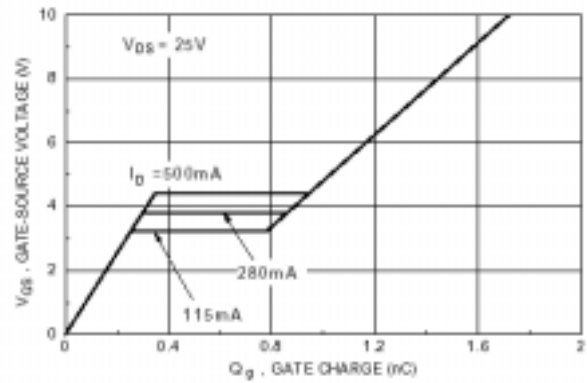

Figure 10. Gate Charge Characteristics

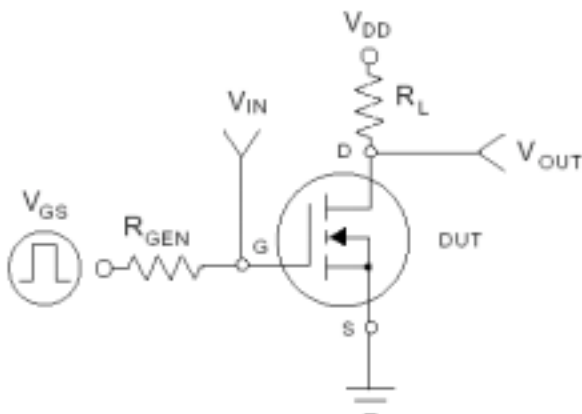

Figure 11. Switching Test Circuit.

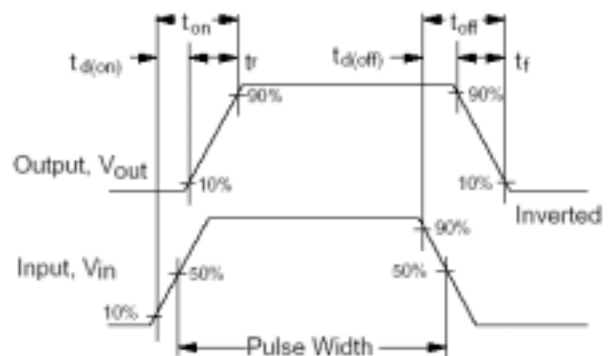

Figure 12. Switching Waveforms.



## Performance Curves

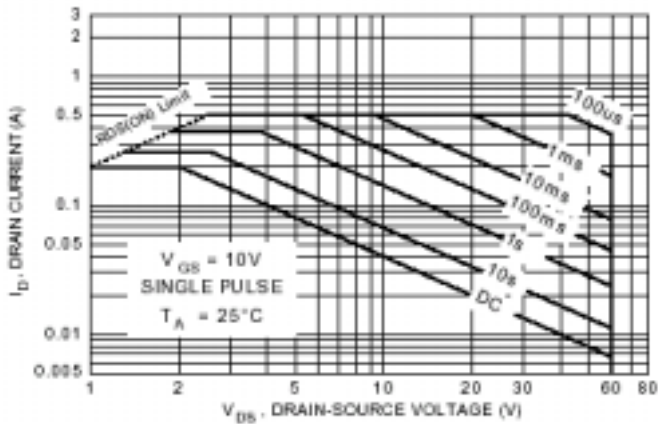

Figure 13. Maximum Safe Operating Area

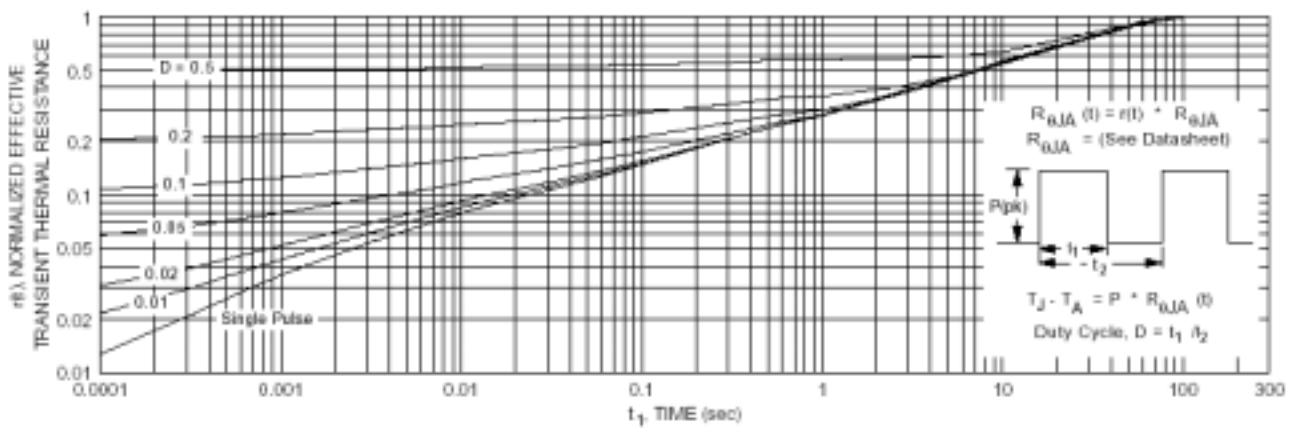

Figure 14. Transient Thermal Response Curve.