

**48Vin
Input**

**+/- 12V
Outputs**

**60 Watt
Power**

**2000Vdc
Isolation**

**Quarter-brick
DC/DC Converter**

The DQ61212QMA06 DualQor™ Mega series is a dual output converter that uses the industry standard quarter brick package size. The very high efficiency is a result of SynQor's patented topology that uses synchronous rectification and an innovative construction design to minimize heat dissipation and allow extremely high power densities. The power dissipated by the converter is so low that a heatsink is not required, which saves cost, weight, height, and application effort. All of the power and control components are mounted to the multi-layer PCB substrate with high-yield surface mount technology, resulting in a more reliable product. RoHS 5/6 Compliant (see page 15).

DualQor
Dual Output



DQ61212QMA06 Module

Operational Features

- Very high efficiency, >91% at full rated load current
- Delivers up to 60 Watts of output power with minimal derating - no heatsink required
- Wide input voltage range: 35V – 75V, with 100V 100ms input voltage transient capability
- Fixed frequency switching provides predictable EMI performance
- No minimum load requirement means no preload resistors required

Mechanical Features

- Industry standard pin-out configuration
- Industry standard size: 1.45" x 2.3" (36.8x58.4mm)
- Total height less than 0.43" (10.9mm), permits better airflow and smaller card pitch
- Total weight: 1.5 oz. (43 g)
- Flanged pins designed to permit surface mount soldering (avoid wave solder) using FPiP technique

Control Features

- On/Off control referenced to input side (positive and negative logic options are available)
- Output voltage trim: +10%/-10%, permits custom voltages and voltage margining

Protection Features

- Input under-voltage lockout disables converter at low input voltage conditions
- Output current limit and short circuit protection protects converter and load from permanent damage and consequent hazardous conditions
- Active back bias limit prevents damage to converter from external load induced pre-bias
- Output over-voltage protection protects load from damaging voltages
- Thermal shutdown protects converter from abnormal environmental conditions

Safety Features

- 2000V, 30 MΩ input-to-output isolation provides input/output ground separation
- UL/cUL 60950-1 recognized (US & Canada), basic insulation rating
- TUV certified to EN60950-1
- Meets 72/23/EEC and 93/68/EEC directives which facilitates CE Marking in user's end product
- Board and plastic components meet UL94V-0 flammability requirements

Input: 35-75V
Outputs: +12V & -12V
Power: 60W
Package: Quarter-brick

MECHANICAL DIAGRAM

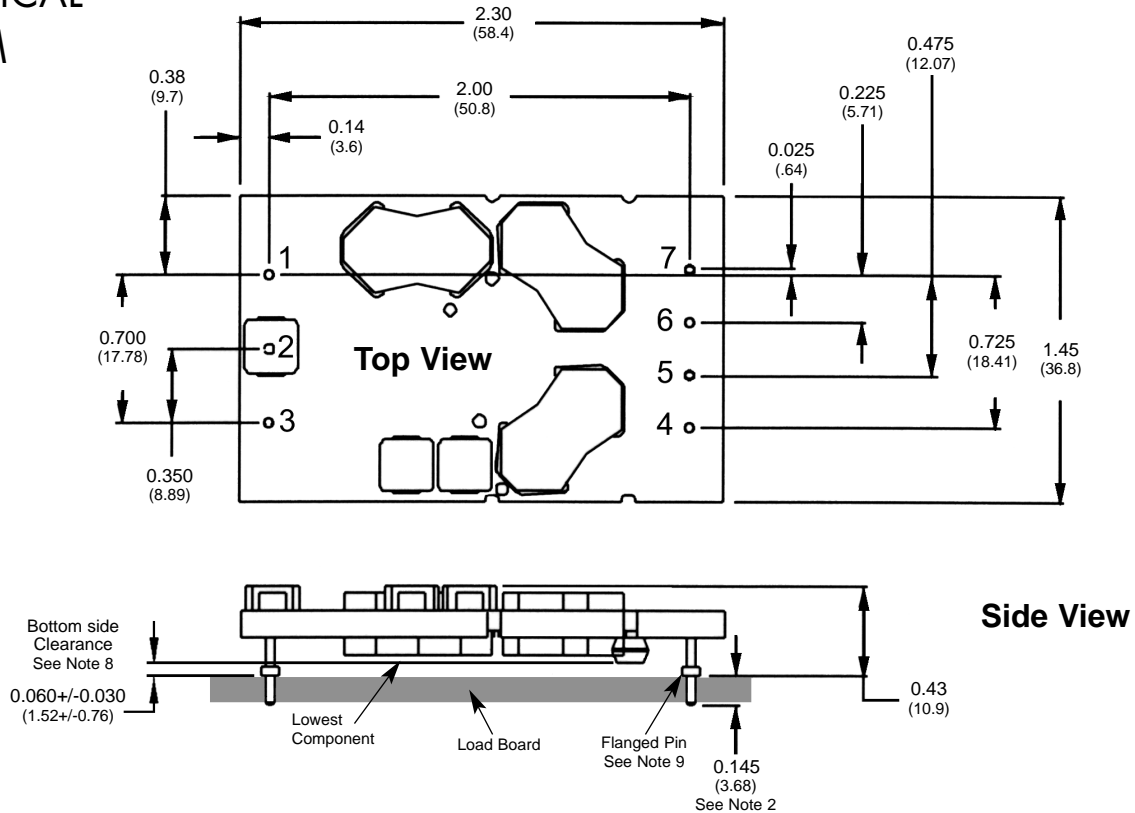

NOTES

- 1) All pins are 0.040" (1.02mm) diameter with 0.080" (2.03 mm) diameter standoff shoulders.
- 2) Other pin extension lengths available. Recommended pin length is 0.03" (0.76mm) greater than the PCB thickness.
- 3) All Pins: Material - Copper Alloy
Finish - Tin/Lead over Nickel plate
- 4) Undimensioned components are shown for visual reference only.
- 5) All dimensions in inches (mm)
Tolerances: x.xx +/-0.02 in. (x.x +/-0.5mm)
x.xxx +/-0.010 in. (x.xx +/-0.25mm)
- 6) Weight: 1.5 oz. (43 g) typical
- 7) Workmanship: Meets or exceeds IPC-A-610C Class II
- 8) UL/TUV standards require a clearance greater than 0.04" (1.02mm) between input and output for Basic insulation. This issue should be considered if any copper traces are on the top side of the user's board. Note that the ferrite cores are considered part of the input/primary circuit.
- 9) The flanged pins are designed to permit surface mount soldering (allowing to avoid the wave soldering process) through the use of the flanged pin-in-paste technique.

PIN DESIGNATIONS

| Pin No. | Name | Function |
|---------|-----------|--|
| 1 | Vin(+) | Positive input voltage |
| 2 | ON/OFF | TTL input to turn converter on and off, referenced to Vin(-), with internal pull up. |
| 3 | Vin(-) | Negative input voltage |
| 4 | 12Vout(-) | 12V negative output voltage |
| 5 | OP RTN | Output Return |
| 6 | TRIM | Output voltage trim |
| 7 | 12Vout(+) | 12V positive output voltage |

DQ61212QMA06 ELECTRICAL CHARACTERISTICS

T_A=25°C, airflow rate=300 LFM, V_{in}=48Vdc unless otherwise noted; full operating temperature range is -40°C to +100°C ambient temperature with appropriate power derating. Specifications subject to change without notice.

| Parameter | Min. | Typ. | Max. | Units | Notes & Conditions |
|--|--------|---------|--------|------------------|--|
| ABSOLUTE MAXIMUM RATINGS | | | | | |
| Input Voltage | | | | | |
| Non-Operating | | | 100 | V | Continuous |
| Operating | | | 80 | V | Continuous |
| Operating Transient Protection | | | 100 | V | 100ms transient, square wave |
| Isolation Voltage (input to output) | | | 2000 | V | Basic insulation, Pollution Degree 2 |
| Operating Temperature | -40 | | 100 | °C | |
| Storage Temperature | -55 | | 125 | °C | |
| Voltage at ON/OFF input pin | -2 | | 18 | V | |
| INPUT CHARACTERISTICS | | | | | |
| Operating Input Voltage Range | 35 | 48 | 75 | V | |
| Input Under-Voltage Lockout | | | | | |
| Turn-On Voltage Threshold | 32 | 33 | 34 | V | |
| Turn-Off Voltage Threshold | 28.5 | 29.5 | 30.5 | V | |
| Lockout Voltage Hysteresis | 2.5 | 3.5 | 4.5 | V | |
| Maximum Input Current | | | 2.1 | A | 100% Load, 35 Vin |
| No-Load Input Current | | 70 | 80 | mA | |
| Disabled Input Current | | 2.0 | 5 | mA | |
| Inrush Current Transient Rating | | | 0.01 | A ² s | |
| Response to Input Transient | | 150 | | mV | 1000V/ms input transient |
| Input Reflected Ripple Current | | | 20 | mA | RMS thru 10µH inductor; Figures 23 & 25 |
| Input Terminal Ripple Current | | 175 | | mA | RMS; Figures 23 & 24 |
| Recommended Input Fuse | | | 20 | A | Fast blow external fuse recommended |
| Input Filter Component Values (L\C) | | 4.7\2.0 | | µH\µF | Internal values; see Figure E |
| Recommended External Input Capacitance | | 47 | | µF | Typical ESR 0.1-0.2Ω, see Figure 23 |
| OUTPUT CHARACTERISTICS | | | | | |
| Output Voltage Set Point (-12V) | | -12.06 | | V | 48Vin, 50% load on each voltage |
| Output Voltage Set Point (+12V) | | 12.06 | | V | 48Vin, 50% load on each voltage |
| Total Output Voltage Regulation (-12V) | -12.60 | | -11.55 | V | Cross regulation, line, load, temp; Figures 7 - 10 |
| Total Output Voltage Regulation (+12V) | 11.55 | | 12.60 | V | Cross regulation, line, load, temp; Figures 7 - 10 |
| Output Voltage Ripple and Noise (±12V) ¹ | | | | | 20MHz bandwidth; Figures 23 & 26 |
| Peak-to-Peak | | 80 | 180 | mV | Full Load; see Figures 23 & 26 |
| RMS | | 12 | 30 | mV | Full Load; see Figures 23 & 26 |
| Operating Output Current Range (±12V) | 0 | | 5 | A | Subject to thermal derating; Figures 11 - 18 |
| Output DC Current-Limit Inception (±12V) | 5.7 | 6 | 6.5 | A | Output Voltage 10% Low; Figures 27 - 28 |
| Short-Circuit Protection - redundant shutdown (±12V) | | 12 | | A | Figures 29 - 30 |
| Output DC Current-Limit Shutdown Voltage | | 8 | | V | |
| Back-Drive Current Limit while Enabled | 0.18 | 0.54 | 0.90 | A | Negative current drawn from output |
| Back-Drive Current Limit while Disabled | | 10 | | mA | Negative current drawn from output |
| Maximum Output Capacitance | | | 4,800 | µF | 12Vout at 5A Resistive Load |
| DYNAMIC CHARACTERISTICS | | | | | |
| Input Voltage Ripple Rejection | | 55 | | dB | 120 Hz; Figures 33 - 34 |
| Output Voltage during Load Current Transient | | | | | |
| For a Step Change in -12V Output Current (.1A/µs) | | 160 | | mV | 50% to 75% to 50% lout max; Figure 21 |
| For a Step Change in +12V Output Current (.1A/µs) | | 160 | | mV | 50% to 75% to 50% lout max; Figure 22 |
| Settling Time | | 200 | | µs | To within 1% Vout nom |
| Turn-On Transient | | | | | |
| Turn-On Time | | 4 | 8 | ms | Full load, Vout=90% nom.; Figures 19 & 20 |
| Start-Up Inhibit Time | 180 | 200 | 240 | ms | -40°C to +125°C; Figure F |
| Output Voltage Overshoot | | 5 | | % | 4,800 µF load capacitance, lout = 0A |
| EFFICIENCY | | | | | |
| 100% Load | | 91.5 | | % | 48Vin, 50% combined Vout; Figures 1 - 6 |
| 50% Load | | 91.5 | | % | 48Vin, 50% combined Vout; Figures 1 - 6 |
| TEMPERATURE LIMITS FOR POWER DERATING CURVES | | | | | |
| Semiconductor Junction Temperature | | | 125 | °C | Package rated to 150°C |
| Board Temperature | | | 125 | °C | UL rated max operating temp 130°C |
| Transformer Temperature | | | 110 | °C | See Figures 11 - 18 for derating curves |
| ISOLATION CHARACTERISTICS | | | | | |
| Isolation Voltage (dielectric strength) | | 2000 | | V | |
| Isolation Resistance | | 30 | | MΩ | |
| Isolation Capacitance ² | | 470 | | pF | |

Note 1: For applications requiring reduced output voltage ripple and noise, consult SynQor applications support (e-mail: support@synqor.com).

Note 2: Higher values of isolation capacitance can be added external to the module.



Technical Specification

Input: 35-75V
Outputs: +12V & -12V
Power: 60W
Package: Quarter-brick

ELECTRICAL CHARACTERISTICS (Continued)

| Parameter | Min. | Typ. | Max. | Units | Notes & Conditions |
|--|-------|------------|------|----------------------|---|
| FEATURE CHARACTERISTICS | | | | | |
| Switching Frequency | 185 | 200 | 215 | kHz | Regulation stage and Isolation stage |
| ON/OFF Control (Option P) | | | | | |
| Off-State Voltage | -2 | | 0.8 | V | |
| On-State Voltage | 2.4 | | 18 | V | |
| ON/OFF Control (Option N) | | | | | |
| Off-State Voltage | 2.4 | | 18 | V | |
| On-State Voltage | -2 | | 0.8 | V | |
| ON/OFF Control (Either Option) | | | | | Figures A & B |
| Pull-Up Voltage | | $V_{in}/6$ | 9.2 | V | |
| Pull-Up Resistance | | 40 | | k Ω | |
| Output Voltage Trim Range | -10 | | +10 | % | Trim-up pins 6-5, Trim-down pins 6-4 |
| Output Over-Voltage Protection (-12V) | -13.7 | -14.5 | -15 | V | Over full temp range |
| Output Over-Voltage Protection (+12V) | 13.7 | 14.5 | 15 | V | Over full temp range |
| Over-Temperature Shutdown | 117 | 122 | 127 | $^{\circ}$ C | Average PCB Temperature |
| Over-Temperature Shutdown Restart Hysteresis | | 10 | | $^{\circ}$ C | |
| RELIABILITY CHARACTERISTICS | | | | | |
| Calculated MTBF (Telcordia) | | 2.05 | | 10 ⁶ Hrs. | TR-NWT-000332; 80% load, 300LFM, 40 $^{\circ}$ C T _a |
| Calculated MTBF (MIL-217) | | 2.5 | | 10 ⁶ Hrs. | MIL-HDBK-217F; 80% load, 300LFM, 40 $^{\circ}$ C T _a |
| Field Demonstrated MTBF | | | | 10 ⁶ Hrs. | See website for details |

STANDARDS COMPLIANCE

| Parameter | Notes |
|---------------------------------|---|
| STANDARDS COMPLIANCE | |
| UL/cUL 60950-1 | File # E194341, Basic insulation & pollution degree 2 |
| EN60950-1 | Certified by TÜV |
| 72/23/EEC | |
| 93/68/EEC | |
| Needle Flame Test (IEC 695-2-2) | Test on entire assembly; board & plastic components UL94V-0 compliant |
| IEC 61000-4-2 | ESD test, 8kV - NP, 15kV air - NP (Normal Performance) |
| GR-1089-CORE | Section 7 - electrical safety, Section 9 - bonding/grounding |
| Telcordia (Bellcore) GR-513 | |

- An external input fuse must always be used to meet these safety requirements. Contact SynQor for official safety certificates on new releases or download from the [SynQor website](#).

QUALIFICATION TESTING

| Parameter | # Units | Test Conditions |
|------------------------------|---------|--|
| QUALIFICATION TESTING | | |
| Life Test | 32 | 95% rated V_{in} and load, units at derating point, 1000 hours |
| Vibration | 5 | 10-55Hz sweep, 0.060" total excursion, 1 min./sweep, 120 sweeps for 3 axis |
| Mechanical Shock | 5 | 100g minimum, 2 drops in x and y axis, 1 drop in z axis |
| Temperature Cycling | 10 | -40 $^{\circ}$ C to 100 $^{\circ}$ C, unit temp. ramp 15 $^{\circ}$ C/min., 500 cycles |
| Power/Thermal Cycling | 5 | Toperating = min to max, V_{in} = min to max, full load, 100 cycles |
| Design Marginality | 5 | Tmin-10 $^{\circ}$ C to Tmax+10 $^{\circ}$ C, 5 $^{\circ}$ C steps, V_{in} = min to max, 0-105% load |
| Humidity | 5 | 85 $^{\circ}$ C, 85% RH, 1000 hours, 2 minutes on and 6 hours off |
| Solderability | 15 pins | MIL-STD-883, method 2003 |

- Extensive characterization testing of all SynQor products and manufacturing processes is performed to ensure that we supply robust, reliable product. Contact the factory for official product family qualification documents.

OPTIONS

SynQor provides various options for Logic Sense, Pin Length and Feature Set for this family of DC/DC converters. Please consult the [last page](#) of this specification sheet for information on available options.

PATENTS

SynQor is protected under various patents, including but not limited to U.S. Patent numbers 5,999,417; 6,222,742 B1; 6,594,159 B2; 6,545,890 B2.

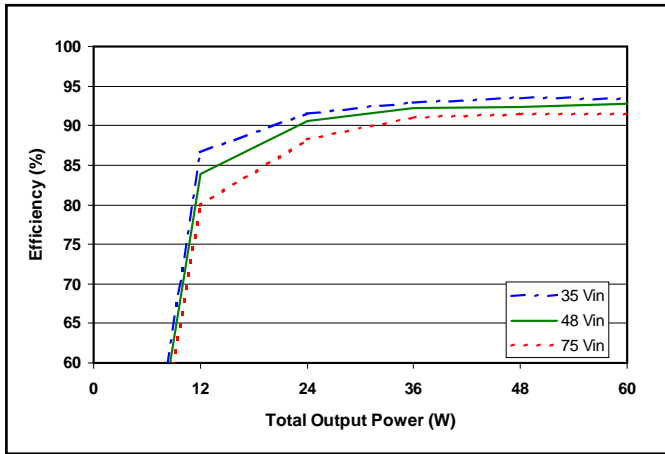

Figure 1: Efficiency vs. output power, from 0 load to full load with 50% load on -12V output and 50% load on +12V output at minimum, nominal, and maximum input voltage at 25°C.

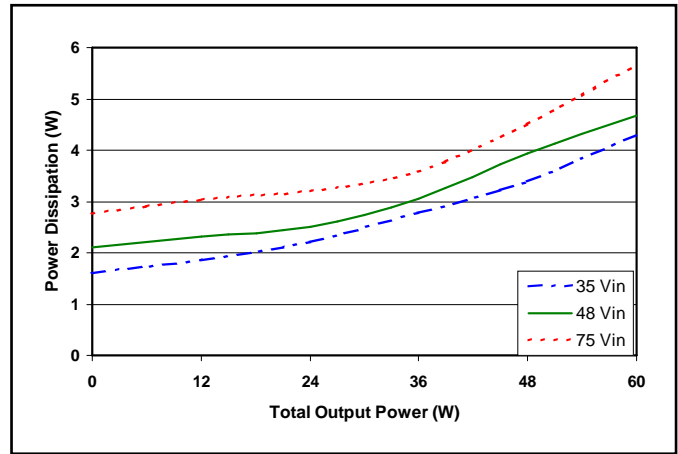

Figure 2: Power dissipation vs. output power, from 0 load to full load with 50% load on -12V output and 50% load on +12V output at minimum, nominal, and maximum input voltage at 25°C.

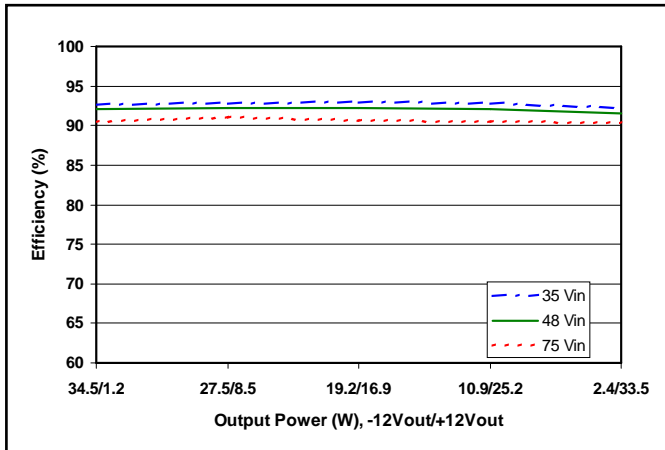

Figure 3: Efficiency vs. output power, with total output power fixed at 60% load (36W) and loads split as shown between -12V and +12V outputs at minimum, nominal, and maximum input voltage at 25°C.

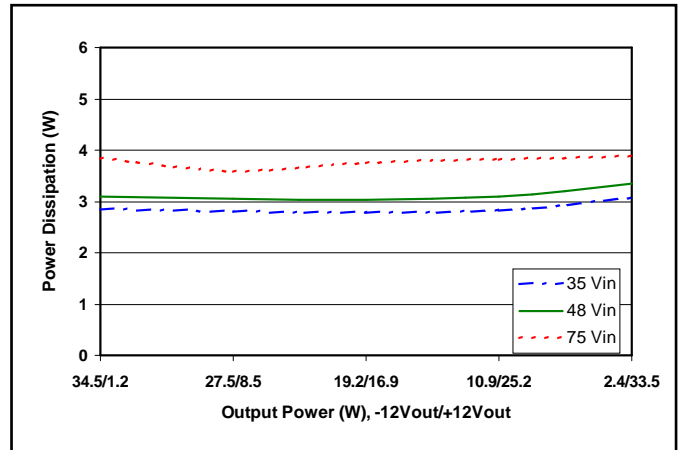

Figure 4: Power dissipation vs. output power, with total output power fixed at 60% load (36W) and loads split as shown between -12V and +12V outputs at minimum, nominal, and max input voltage at 25°C.

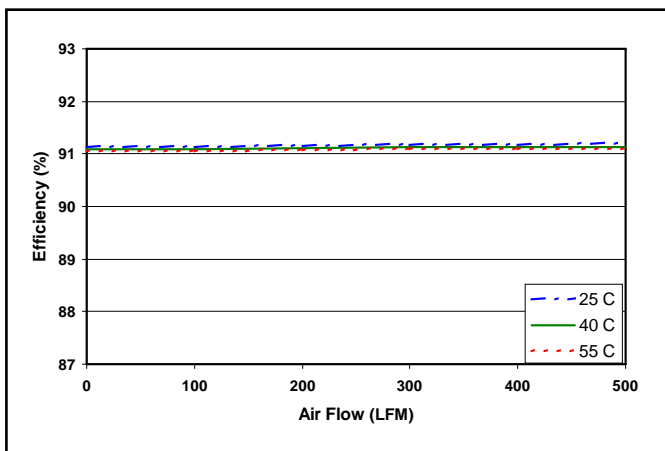

Figure 5: Efficiency vs. load current, with 80% load and 50/50 voltage split (2A load on -12V and 2A load on +12V) over variations in temperature and airflow.

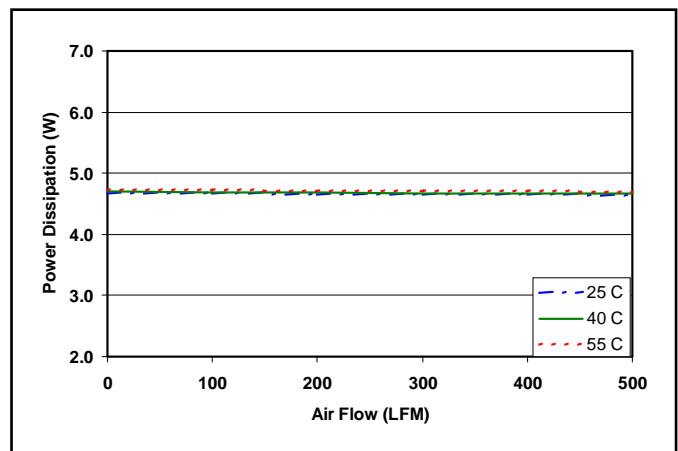

Figure 6: Power dissipation vs. load current, with 80% load and 50/50 voltage split (2A load on -12V and 2A load on +12V) over variations in temperature and airflow.

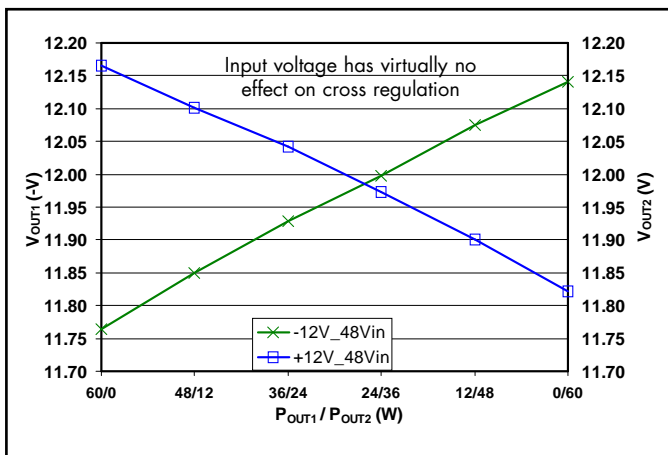

Figure 7: Load regulation vs. load current with power fixed at full load (60W) and load currents split as shown between -12V and +12V outputs, at nominal input voltage.

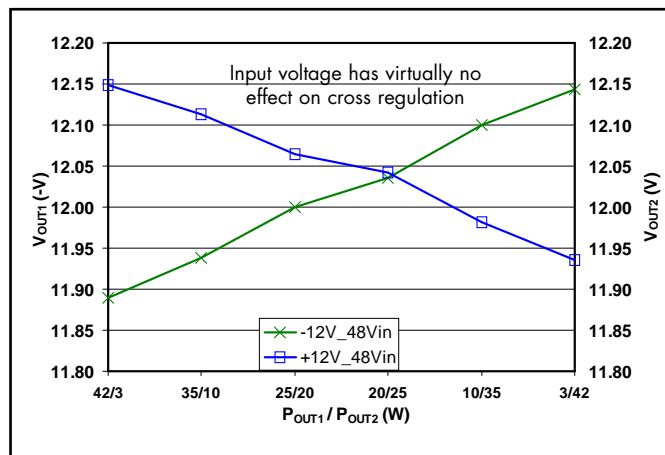

Figure 8: Load regulation vs. load current with power fixed at 75% load (45W) and load currents split as shown between -12V and +12V outputs, at nominal input voltage.

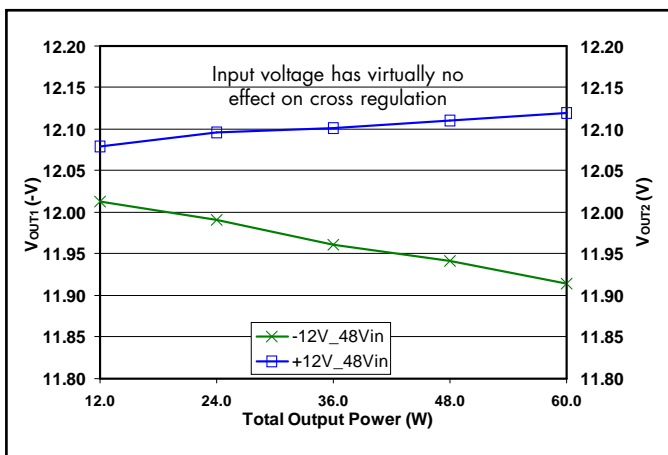

Figure 9: Load regulation vs. output power from 12W load to full load with 75% load on -12V output and 25% load on +12V output at nominal input voltage.

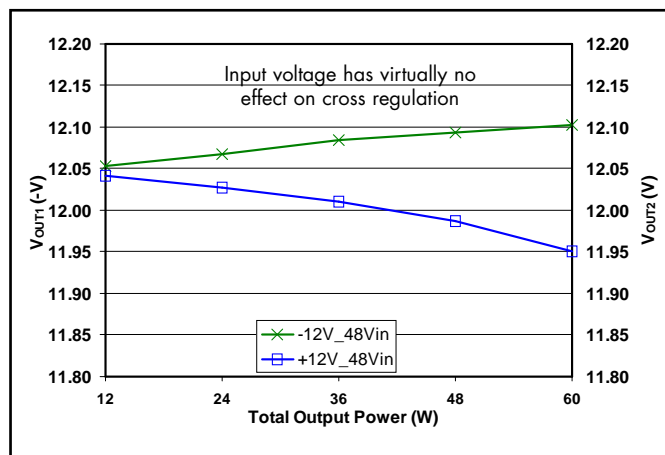

Figure 10: Load regulation vs. output power from 12W load to full load with 25% load on -12V output and 75% load on +12V output at nominal input voltage.

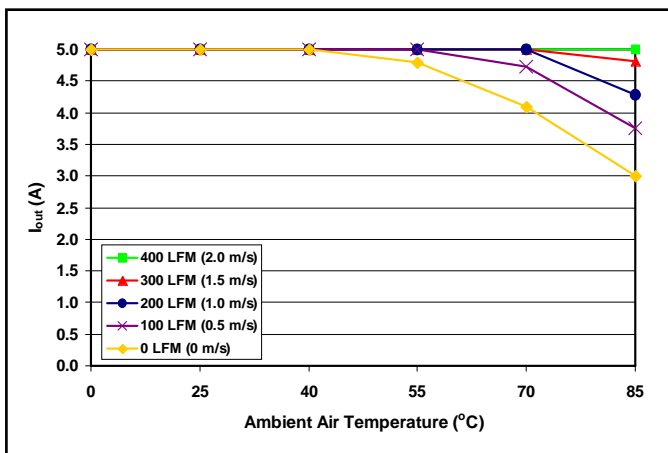

Figure 11: Maximum output power derating curves vs. ambient air temperature for airflow rates of 0 to 400 LFM, air flowing from pin 1 to pin 3. Full load (5A) on -12V output and no load on +12V output.

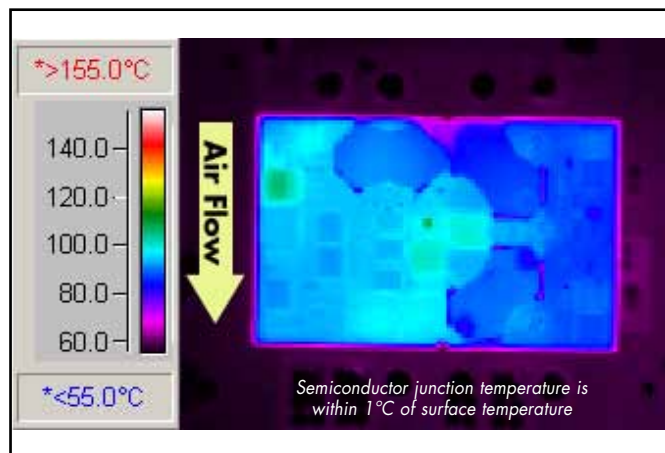

Figure 12: Thermal plot of converter at 5 amp load on -12V output and no load on +12V output with 55°C air flowing at 200 LFM. Air flow across the converter is from pin 1 to pin 3 (nominal input voltage)

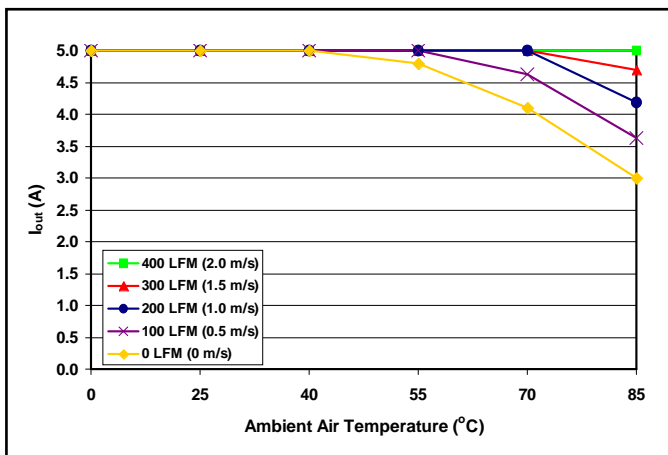

Figure 13: Maximum output power derating curves vs. ambient air temperature for airflow rates of 0 to 400 LFM, air flowing from pin 1 to pin 3. Full load (5A) on +12V output and no load on -12V output.

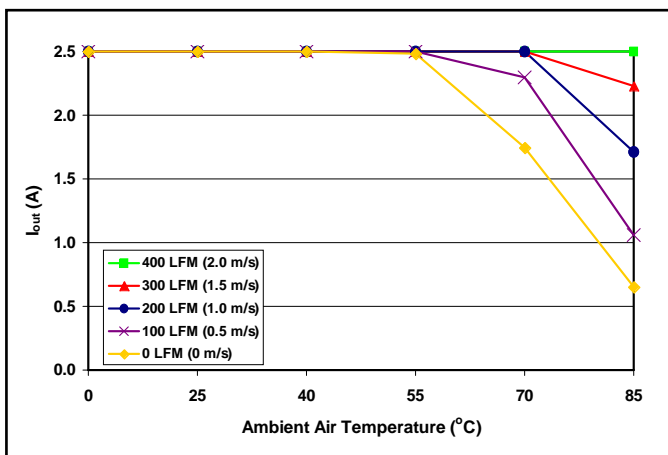

Figure 15: Max output power derating curves vs. air temp for 0 to 400 LFM, pin 1 to pin 3. 50% load (2.5A) on -12V output and 50% load (2.5A) on +12V output. At derating points, +12V output decreases while -12V output remains unchanged.

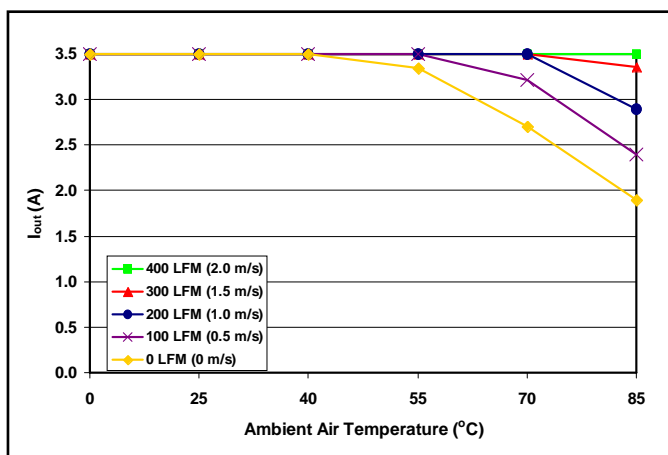

Figure 17: Max output power derating curves vs. air temp for 0 to 400 LFM, pin 1 to pin 3. 30% load (1.5A) on -12V output and 70% load (3.5A) on +12V output. At derating points, +12V output decreases while -12V output remains unchanged.

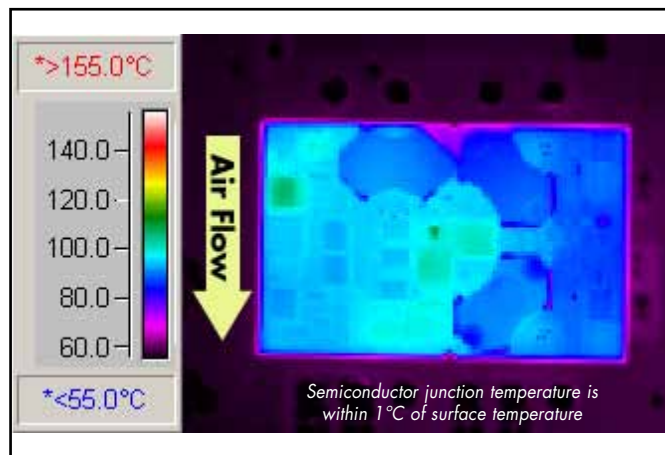

Figure 14: Thermal plot of converter at 5 amp load on +12V output and no load on -12V output with 55°C air flowing at 200 LFM. Air flow across the converter is from pin 1 to pin 3 (nominal Vin)

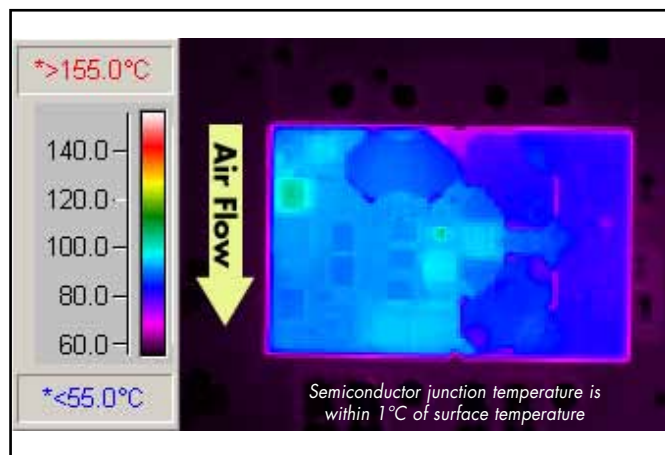

Figure 16: Thermal plot of converter at 2.5 amp load on -12V output and 2.5 amp load on +12V output with 55°C air flowing at 200 LFM. Air flow across the converter is from pin 1 to pin 3 (nominal Vin)

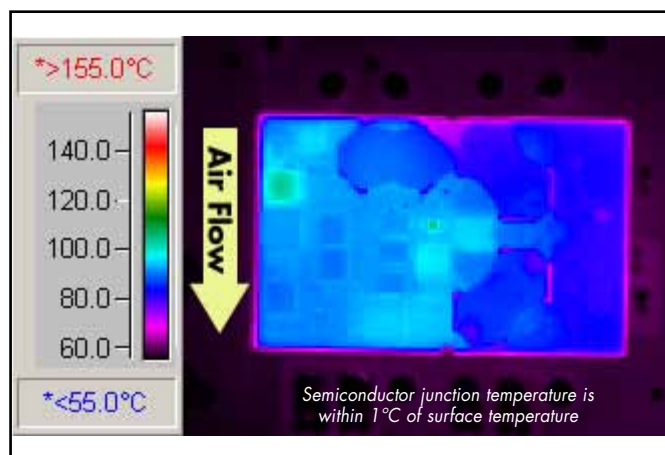

Figure 18: Thermal plot of converter at 3.5 amp load on +12V output and 1.5 amp load on -12V output with 55°C air flowing at 200 LFM. Air flow across the converter is from pin 1 to pin 3 (nominal Vin).

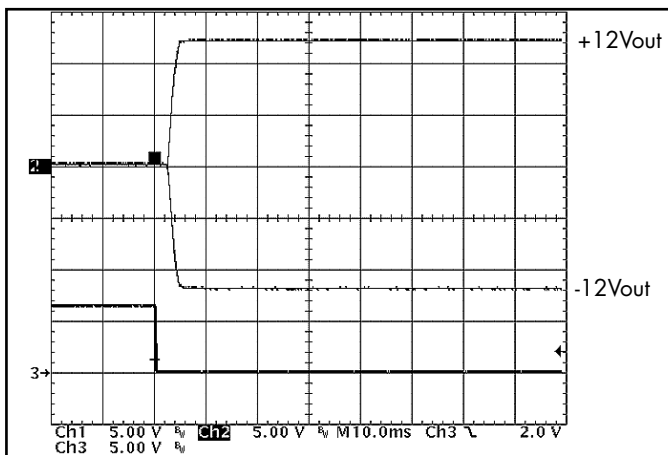

Figure 19: Turn-on transient at full rated load current (resistive load) (10 ms/div). Input voltage pre-applied. Ch 1: -12Vout (5V/div); Ch 2: +12Vout (5V/div); Ch 3: ON/OFF input (5V/div).

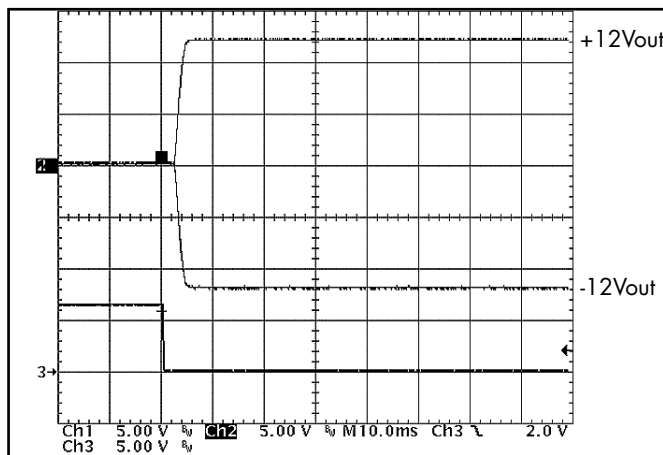

Figure 20: Turn-on transient at zero load current (10 ms/div). Ch 1: -12Vout (5V/div); Ch 2: +12Vout (5V/div); Ch 3: ON/OFF input (5V/div).

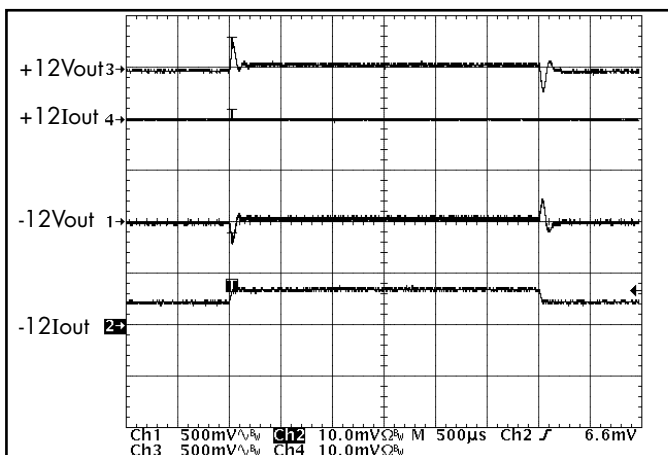

Figure 21: Output voltage response to step-change in I_{out1} (50%-75%-50% of I_{max} ; $dI/dt = 0.1A/\mu s$). Load cap: 15µF, 300 mΩ ESR tantalum cap & 1µF ceramic cap. V_{out} (500mV/div), I_{out} (5A/div). Ch1: V_{out1} ; Ch2 I_{out1} ; Ch 3: V_{out2} ; Ch 4 I_{out2}

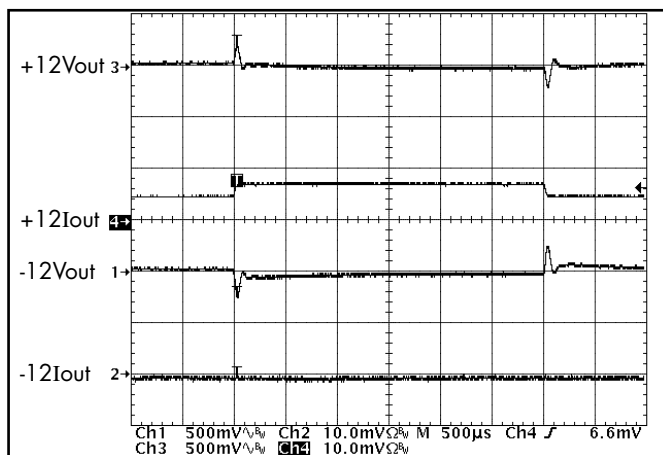

Figure 22: Output voltage response to step-change in I_{out2} (50%-75%-50% of I_{max} ; $dI/dt = 0.1A/\mu s$). Load cap: 15µF, 300 mΩ ESR tantalum cap & 1µF ceramic cap.. V_{out} (500mV/div), I_{out} (5A/div). Ch1: V_{out1} ; Ch2 I_{out2} ; Ch 3: V_{out2} ; Ch 4 I_{out2}

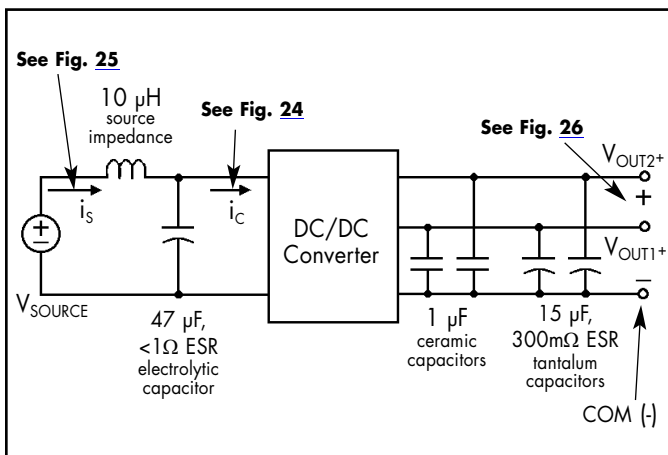

Figure 23: Test set-up diagram showing measurement points for Input Terminal Ripple Current (Figure 24), Input Reflected Ripple Current (Figure 25) and Output Voltage Ripple (Figure 26).

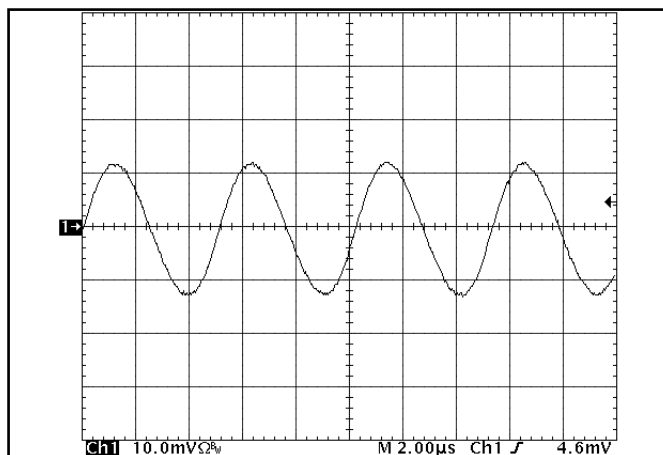

Figure 24: Input Terminal Ripple Current, -12V & +12V outputs at 50% rated output current and nominal input voltage with 10µH source impedance and 100µF electrolytic capacitor (200 mA/div). (see Fig. 23)

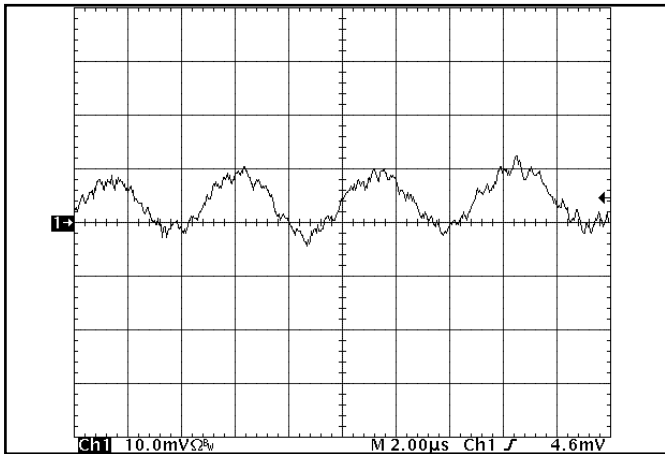

Figure 25: Input reflected ripple current, i_s , through a $10\ \mu\text{H}$ source inductor at nominal input voltage and rated load current (5 mA/div). -12V and +12V outputs at 50% rated load current. (see Fig. 23)

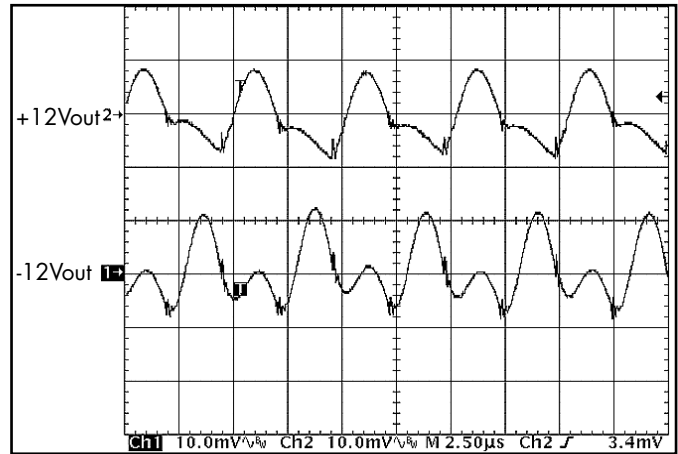

Figure 26: Output voltage ripple at nominal input voltage and 50% rated load current on both outputs (10 mV/div). Load capacitance: $1\ \mu\text{F}$ ceramic cap & $15\ \mu\text{F}$ tantalum cap. Bandwidth: 20 MHz. (see Fig. 23)

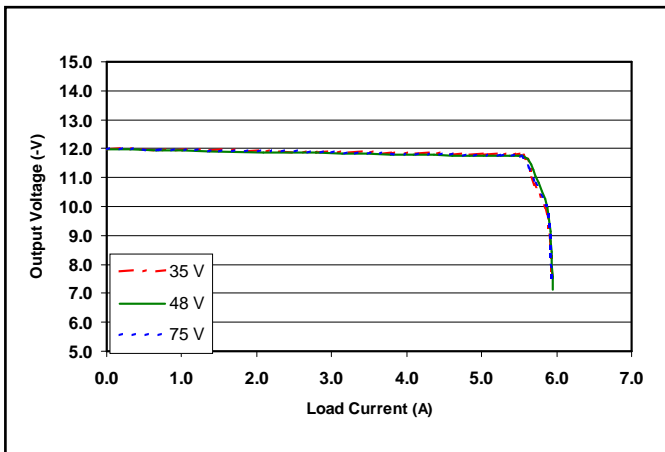

Figure 27: Output voltage vs. load current showing typical current limit curves and converter shutdown points for the -12V output. +12V load is at 0A.

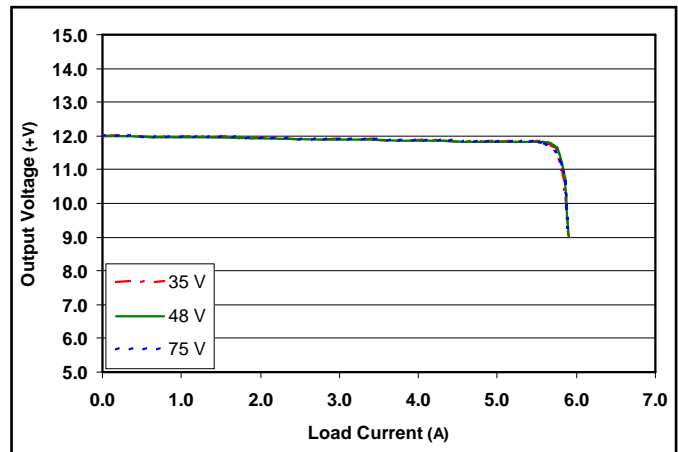

Figure 28: Output voltage vs. load current showing typical current limit curves and converter shutdown points for the +12V output. -12V load is at 0A.

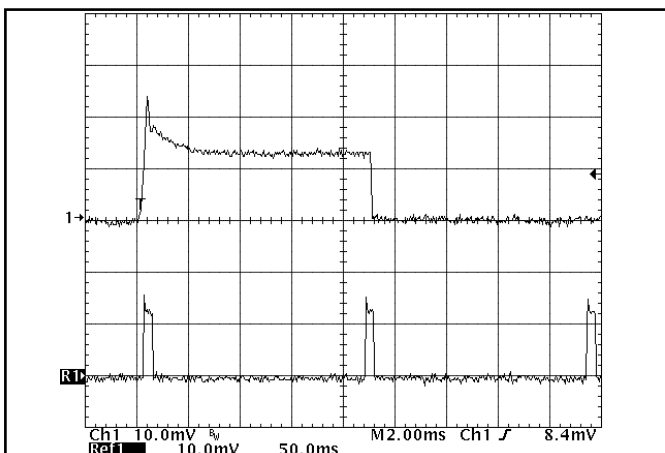

Figure 29: Load current for -12V output (2A/div) as a function of time when the converter attempts to turn on into a $10\ \text{m}\Omega$ short circuit. Top trace is an expansion of the on-time portion of the bottom trace.

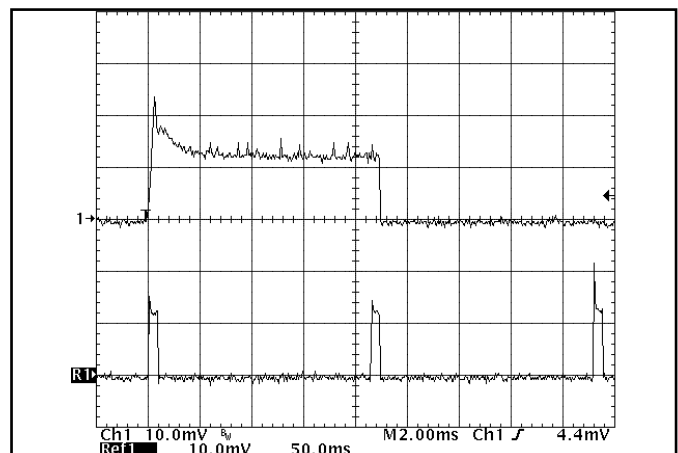

Figure 30: Load current for +12V output (2A/div) as a function of time when the converter attempts to turn on into a $10\ \text{m}\Omega$ short circuit. Top trace is an expansion of the on-time portion of the bottom trace.

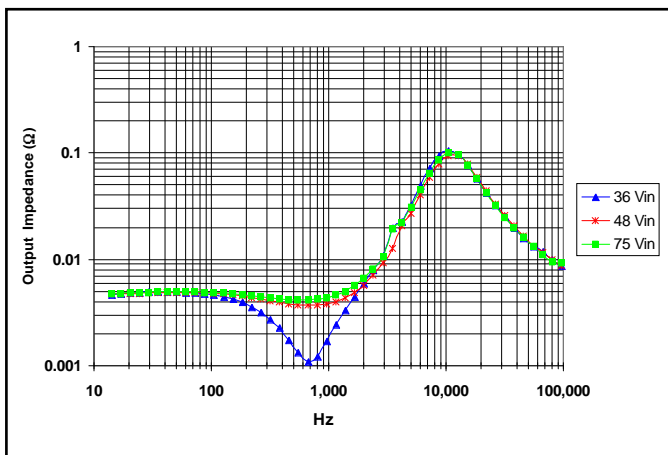

Figure 31: Output impedance ($Z_{out1} = V_{out1}/I_{out1}$) for minimum, nominal, and maximum input voltage at full rated power, for -12V output.

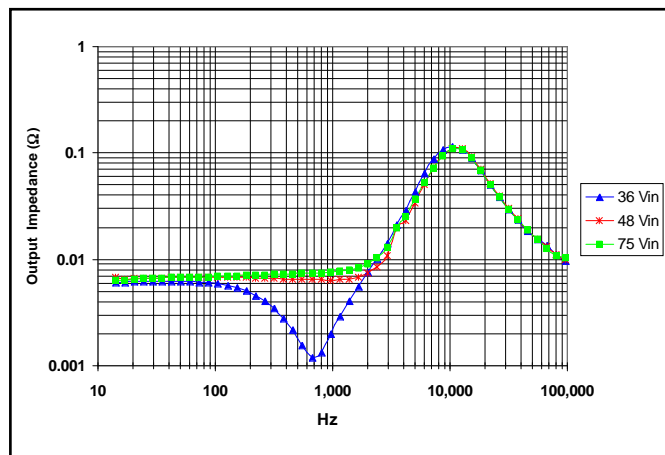

Figure 32: Output impedance ($Z_{out2} = V_{out2}/I_{out2}$) for minimum, nominal, and maximum input voltage at full rated power, for +12V output.

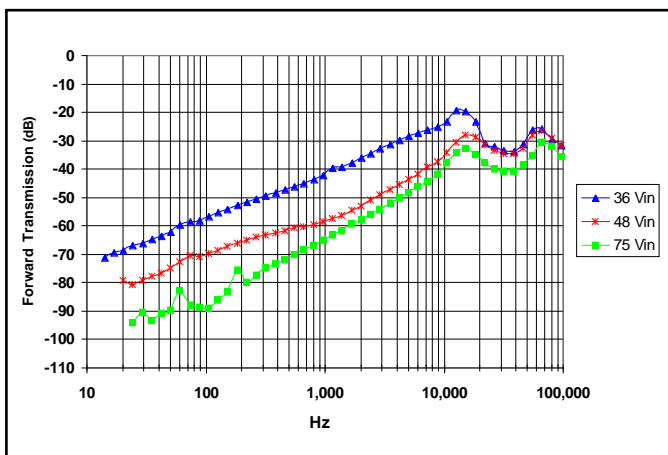

Figure 33: Forward Transmission ($FT_1 = V_{out1}/V_{in}$) for minimum, nominal, and maximum input voltage at full rated power, for -12V output.

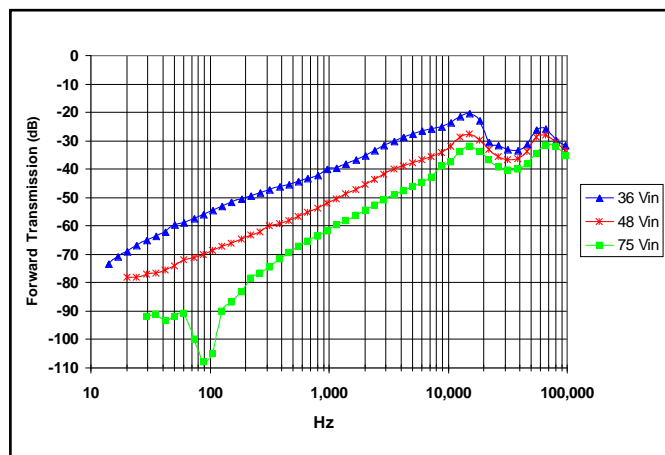

Figure 34: Forward Transmission ($FT_2 = V_{out2}/V_{in}$) for minimum, nominal, and maximum input voltage at full rated power, for +12V output.

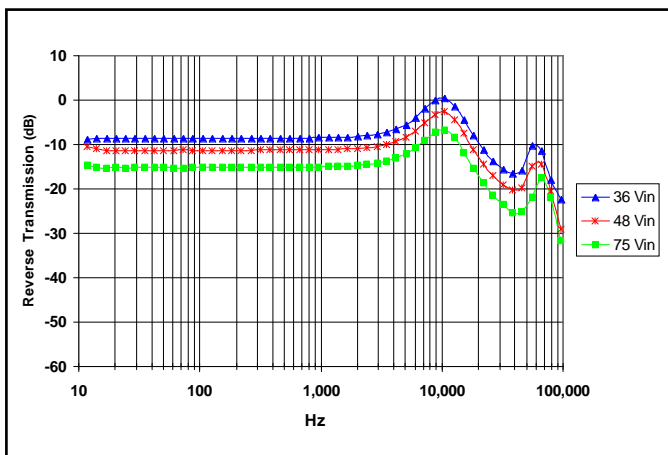

Figure 35: Reverse Transmission ($RT_1 = I_{in}/I_{out1}$) for minimum, nominal, and maximum input voltage at full rated power, for -12V output.

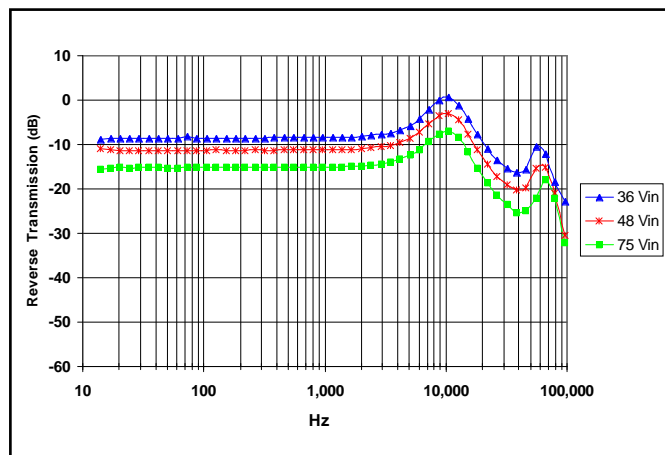

Figure 36: Reverse Transmission ($RT_2 = I_{in}/I_{out2}$) for minimum, nominal, and maximum input voltage at full rated power, for +12V output.

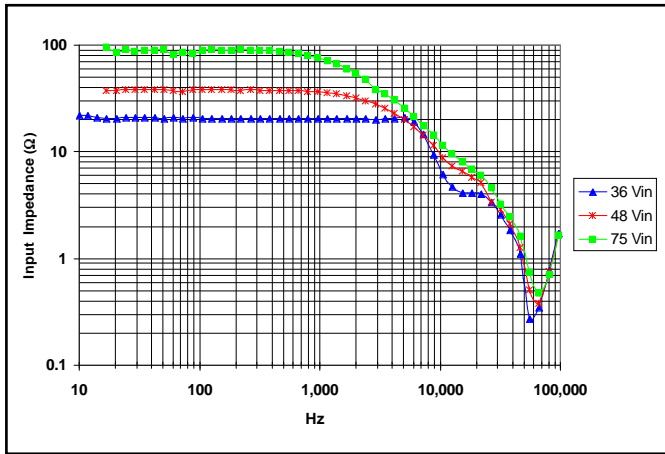

Figure 37: Input impedance ($Z_{in} = V_{in}/I_{in}$) for minimum, nominal, and maximum input voltage at full rated power.

BASIC OPERATION AND FEATURES

The *DualQor* series converter uses a two-stage power conversion topology in which the two output voltages are cross regulated. The first stage is a buck-converter that keeps the output voltage constant over variations in line, load, and temperature. The second stage uses a transformer to provide the functions of input/output isolation and voltage step-down to achieve the low output voltage required.

The two-stage solution is ideal for converters with multiple cross-regulated output voltages. The first-stage compensates for any variations in line voltage. Therefore, the dependence of the output voltage on line variations is minimized.

Both the first stage and the second stage switch at a fixed frequency for predictable EMI performance. Rectification of the transformer's output is accomplished with synchronous rectifiers. These devices, which are MOSFETs with a very low on-state resistance, dissipate far less energy than Schottky diodes. This is the primary reason that the *DualQor* series of converters has such high efficiency, even at very low output voltages and very high output currents.

Dissipation throughout the converter is so low that it does not require a heatsink for operation. However, baseplated versions are available for optional heatsinking in severe thermal environments.

The *DualQor* series converter uses the industry standard footprint and pin-out configuration.

The *DualQor* has many standard control and protection features. All shutdown features are non-latching, meaning that the converter shuts off for 200 ms before restarting (see Figure E).

CONTROL FEATURES

REMOTE ON/OFF (Pin 2): The ON/OFF input, Pin 2, permits the user to control when the converter is *on* or *off*. This input is referenced to the return terminal of the input bus, $V_{in(-)}$. There are two versions of the converter that differ by the sense of the logic used for the ON/OFF input.

In the positive logic version, the ON/OFF input is active high (meaning that a high turns the converter *on*). In the negative logic version, the ON/OFF signal is active low (meaning that a low turns the converter *on*). Figure A details five possible circuits for driving the ON/OFF pin. Figure B is a detailed look of the internal ON/OFF circuitry.

OUTPUT VOLTAGE TRIM (Pin 6): The TRIM input permits the user to adjust the output voltage up or down according to the trim range specifications. It is important to recognize that adjusting one output will also adjust the second output proportionally. To lower the output voltage, the user should connect a resistor between Pin 6 and Pin 7. To raise the output voltage, the user should connect a resistor between Pin 6 and Pin 5. The following table shows the resistor values needed to trim the output volt-

| Vo(%) | 1 | 2 | 3 | 4 | 5 | 6 | 7 | 8 | 9 | 10 |
|-------------------------|-----|-----|-------|------|------|------|------|-------|------|----|
| <i>R_{up}</i> | 397 | 178 | 105 | 68.4 | 46.5 | 31.9 | 21.5 | 13.65 | 7.57 | 0 |
| <i>R_{down}</i> | 466 | 208 | 121.5 | 78.4 | 52.7 | 35.4 | 23.1 | 13.87 | 6.7 | 0 |

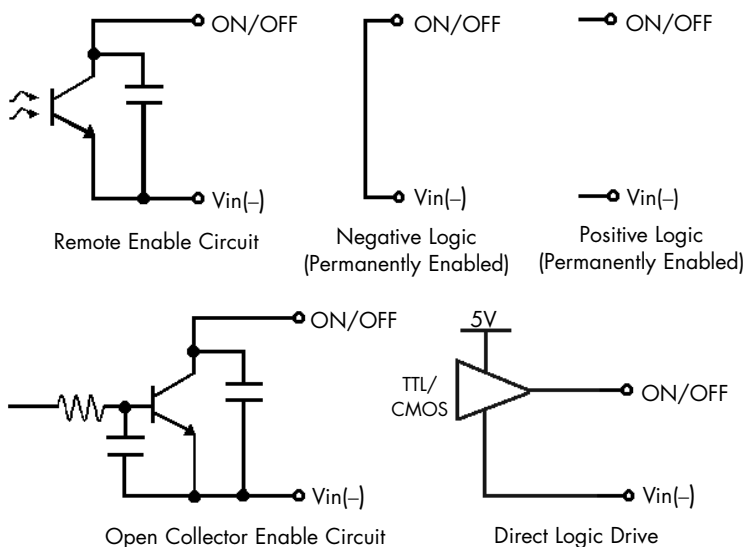

Figure A: Various circuits for driving the ON/OFF pin.

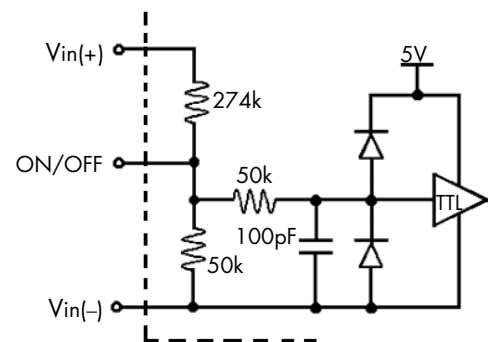

Figure B: Internal ON/OFF pin circuitry

age up or down.

Resistor values in Kohms for the desired increase/decrease (typical) in output voltage (%)

Note: The TRIM feature does not affect the voltage at which the output over-voltage protection circuit is triggered. Trimming the output voltage too high may cause the over-voltage protection circuit to engage, particularly during transients.

Total DC Variation of Vout: For the converter to meet its full specifications, the maximum variation of the DC value of Vout, due to both trimming and remote load voltage drops, should not be greater than that specified for the output voltage trim range.

PROTECTION FEATURES

Input Under-Voltage Lockout: The converter is designed to turn off when the input voltage is too low, helping avoid an input system instability problem, described in more detail in the application note titled "Input System Instability" on our web. The lock-out circuitry is a comparator with DC hysteresis. When the input voltage is rising, it must exceed the typical Turn-On Voltage Threshold value (listed on the specification page) before the converter will turn on. Once the converter is on, the input voltage must fall below the typical Turn-Off Voltage Threshold value before the converter will turn off.

Output Current Limit: The maximum current limit remains constant as the output voltage drops. However, once the impedance of the short across the output is small enough to make the output voltage drop below the specified Output DC Current-Limit Shutdown Voltage, the converter turns off.

The converter then enters a "hiccup mode" where it repeatedly turns on and off at a 5 Hz (nominal) frequency with a 5% duty

cycle until the short circuit condition is removed. This prevents excessive heating of the converter or the load board.

Output Over-Voltage Limit: If the voltage across the output pins exceeds the Output Over-Voltage Protection threshold, the converter will immediately stop switching. This prevents damage to the load circuit due to 1) excessive series resistance in output current path from converter output pins to sense point, 2) a release of a short-circuit condition, or 3) a release of a current limit condition. Load capacitance determines exactly how high the output voltage will rise in response to these conditions. After 200 ms the converter will automatically restart.

Over-Temperature Shutdown: A temperature sensor on the converter senses the average temperature of the module. The thermal shutdown circuit is designed to turn the converter off when the temperature at the sensed location reaches the Over-Temperature Shutdown value. It will allow the converter to turn on again when the temperature of the sensed location falls by the amount of the Over-Temperature Shutdown Restart Hysteresis value.

APPLICATION CONSIDERATIONS

Input System Instability: This condition can occur because any DC/DC converter appears incrementally as a negative resistance load. A detailed application note titled "Input System Instability" is available on the SynQor website which provides an understanding of why this instability arises, and shows the preferred solution for correcting it.

Application Circuits: Figure D below provides a typical circuit diagram which details the input filtering and voltage trimming.

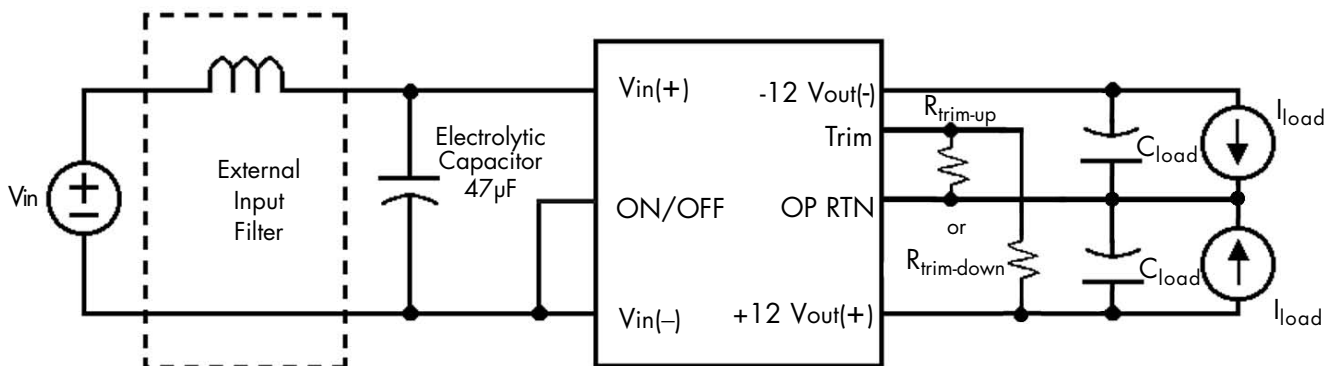

Figure D: Typical application circuit (negative logic unit, permanently enabled).

Input Filtering and External Capacitance: Figure E provides a diagram showing the internal input filter components. This filter dramatically reduces input terminal ripple current, which otherwise could exceed the rating of an external electrolytic input capacitor. The recommended external input capacitance is specified in the "Input Characteristics" section. More detailed information is available in the application note titled "EMI Characteristics" on the SynQor website.

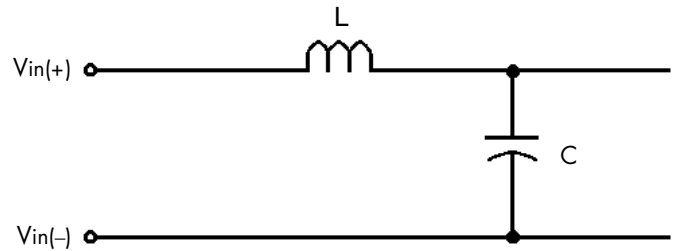

Figure E: Internal Input Filter Diagram (values listed on page 3).

Startup Inhibit Period: The Startup Inhibit Period ensures that the converter will remain off for at least 200ms when it is shut down for any reason. When an output short is present, this generates a 5Hz "hiccup mode," which prevents the converter from overheating. In all, there are seven ways that the converter can be shut down, initiating a Startup Inhibit Period:

- Input Under-Voltage Lockout
- Input Over-Voltage Shutdown (not present in Quarter-brick)
- Output Over-Voltage Protection
- Over Temperature Shutdown
- Current Limit
- Short Circuit Protection
- Turned off by the ON/OFF input

Figure F shows three turn-on scenarios, where a Startup Inhibit Period is initiated at t_0 , t_1 , and t_2 :

Before time t_0 , when the input voltage is below the UVL threshold, the unit is disabled by the Input Under-Voltage Lockout feature. When the input voltage rises above the UVL threshold, the Input Under-Voltage Lockout is released, and a Startup Inhibit Period is initiated. At the end of this delay, the ON/OFF pin is evaluated, and since it is active, the unit turns on.

At time t_1 , the unit is disabled by the ON/OFF pin, and it cannot be enabled again until the Startup Inhibit Period has elapsed.

When the ON/OFF pin goes high after t_2 , the Startup Inhibit Period has elapsed, and the output turns on within the typical Turn-On Time.

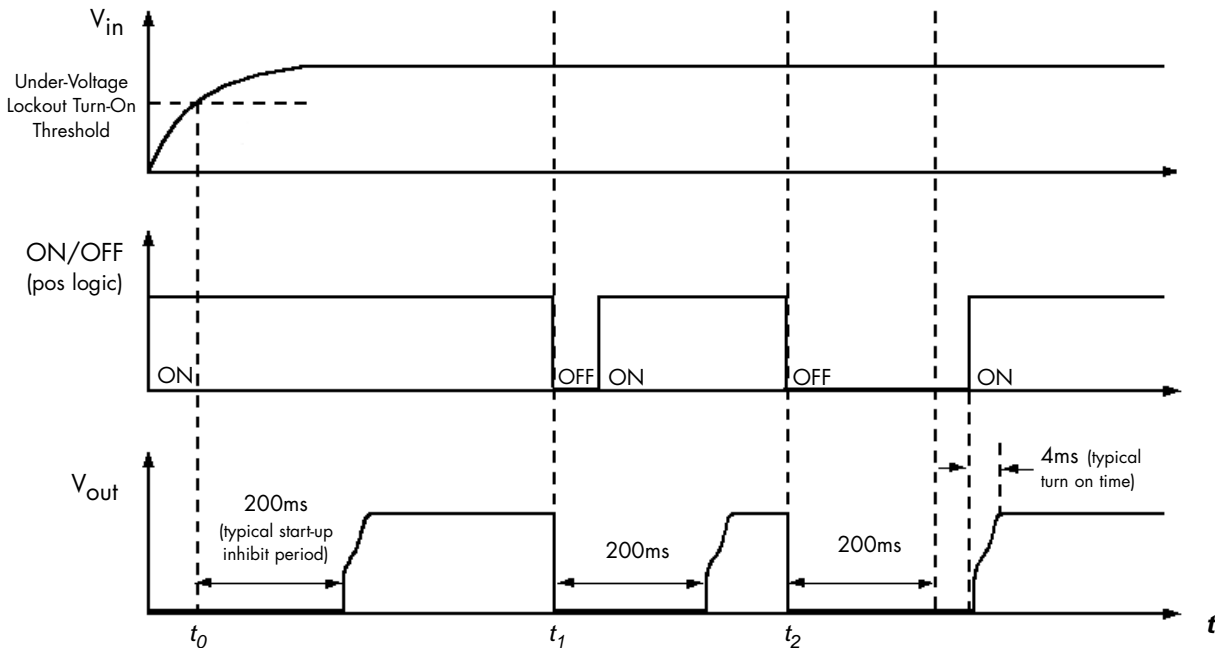

Figure F: Startup Inhibit Period (turn-on time not to scale)



Technical Specification

Input: 35-75V
Outputs: +12V & -12V
Power: 60W
Package: Quarter-brick

PART NUMBERING SYSTEM

The part numbering system for SynQor's DualQor DC/DC converters follows the format shown in the example below.

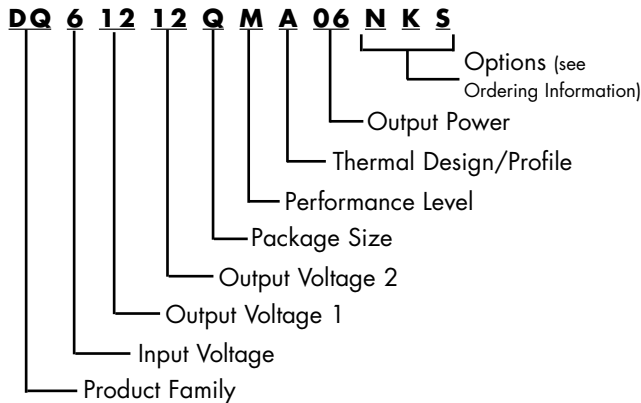

The first 12 characters comprise the base part number and the last 3 characters indicate available options. Although there are no default values for enable logic and pin length, the most common options are negative logic and 0.145" pins. These part numbers are more likely to be readily available in stock for evaluation and prototype quantities.

Application Notes

A variety of application notes and technical white papers can be downloaded in pdf format at www.synqor.com.

Contact SynQor for further information:

Phone: 978-849-0600
Toll Free: 888-567-9596
Fax: 978-849-0602
E-mail: power@synqor.com
Web: www.synqor.com
Address: 155 Swanson Road
 Boxborough, MA 01719
 USA

ORDERING INFORMATION

The tables below show the valid model numbers and ordering options for converters in this product family. When ordering SynQor converters, please ensure that you use the complete 15 character part number consisting of the 12 character base part number and the additional 3 characters for options.

| Model Number | Input Voltage | Output Voltages | Max Output Power |
|-----------------|---------------|-----------------|------------------|
| DQ63318QMA04xyz | 35 - 75 V | 3.3/1.8 V | 40 W |
| DQ63325QMA04xyz | 35 - 75 V | 3.3/2.5 V | 40 W |
| DQ65033QMA06xyz | 35 - 75 V | 5.0/3.3 V | 60 W |
| DQ61212QMA06xyz | 35 - 75 V | +12/-12 V | 60 W |

The following option choices must be included in place of the x y z spaces in the model numbers listed above.

| Options Description: x y z | | |
|------------------------------|--|--------------|
| Enable Logic | Pin Length | Feature Set |
| P - Positive N - Negative | K - 0.110" N - 0.145" R - 0.180" Y - 0.250" | S - Standard |

RoHS Compliance: The EU led RoHS (Restriction of Hazardous Substances) Directive bans the use of Lead, Cadmium, Hexavalent Chromium, Mercury, Polybrominated Biphenyls (PBB), and Polybrominated Diphenyl Ether (PBDE) in Electrical and Electronic Equipment. SynQor products are currently 5/6 RoHS compliant with lead being the exception. For more information please visit our [RoHS Compliance / Lead Free Initiative](#) web page or e-mail us at rohs@synqor.com.

Warranty

SynQor offers a three (3) year limited warranty. Complete warranty information is listed on our [website](#) or is available upon request from SynQor.

Information furnished by SynQor is believed to be accurate and reliable. However, no responsibility is assumed by SynQor for its use, nor for any infringements of patents or other rights of third parties which may result from its use. No license is granted by implication or otherwise under any patent or patent rights of SynQor.