

Silicon NPN Power Transistors

2SC3148

DESCRIPTION

- With TO-220C package
- High collector breakdown voltage:
 $V_{CEO}=800V(\text{Min})$
- Excellent switching time:
 $t_r=1.0 \mu s(\text{Max.})$
 $t_f=1.0 \mu s(\text{Max.}@I_C=0.8A)$

APPLICATIONS

- Switching regulator and high voltage switching applications
- High speed DC-DC converter applications

PINNING

PIN	DESCRIPTION
1	Base
2	Collector;connected to mounting base
3	Emitter

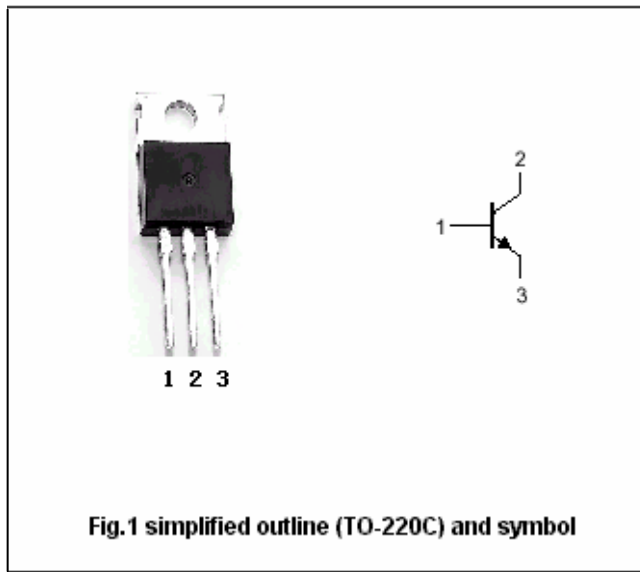

Absolute maximum ratings($T_a=25^\circ C$)

SYMBOL	PARAMETER	CONDITIONS	VALUE	UNIT
V_{CBO}	Collector-base voltage	Open emitter	900	V
V_{CEO}	Collector-emitter voltage	Open base	800	V
V_{EBO}	Emitter-base voltage	Open collector	7	V
I_C	Collector current		3	A
I_{CM}	Collector current-peak		5	A
I_B	Base current		1	A
P_C	Collector dissipation	$T_a=25$	1.5	W
		$T_C=25$	40	
T_j	Junction temperature		150	
T_{stg}	Storage temperature		-55~150	

Silicon NPN Power Transistors

2SC3148

CHARACTERISTICS

T_j=25 unless otherwise specified

SYMBOL	PARAMETER	CONDITIONS	MIN	TYP.	MAX	UNIT
V _{(BR)CEO}	Collector-emitter breakdown voltage	I _C =10mA ; I _B =0	800			V
V _{(BR)CBO}	Collector-base breakdown voltage	I _C =1mA ; I _E =0	900			V
V _{CEsat}	Collector-emitter saturation voltage	I _C =0.8A; I _B =0.16A			0.6	V
V _{BEsat}	Base-emitter saturation voltage	I _C =0.8A; I _B =0.16A			1.2	V
I _{CBO}	Collector cut-off current	V _{CB} =800V ; I _E =0			100	μA
I _{EBO}	Emitter cut-off current	V _{EB} =7V; I _C =0			1	mA
h _{FE}	DC current gain	I _C =0.8A ; V _{CE} =5V	10			

Switching times

t _r	Rise time	V _{CC} 400V; I _C =0.8A I _{B1} =0.08A; I _{B2} =-0.20A; R _L =50 ;Duty cycle 1%			1.0	μs
t _{stg}	Storage time				4.0	μs
t _f	Fall time				1.0	μs

Silicon NPN Power Transistors

2SC3148

PACKAGE OUTLINE

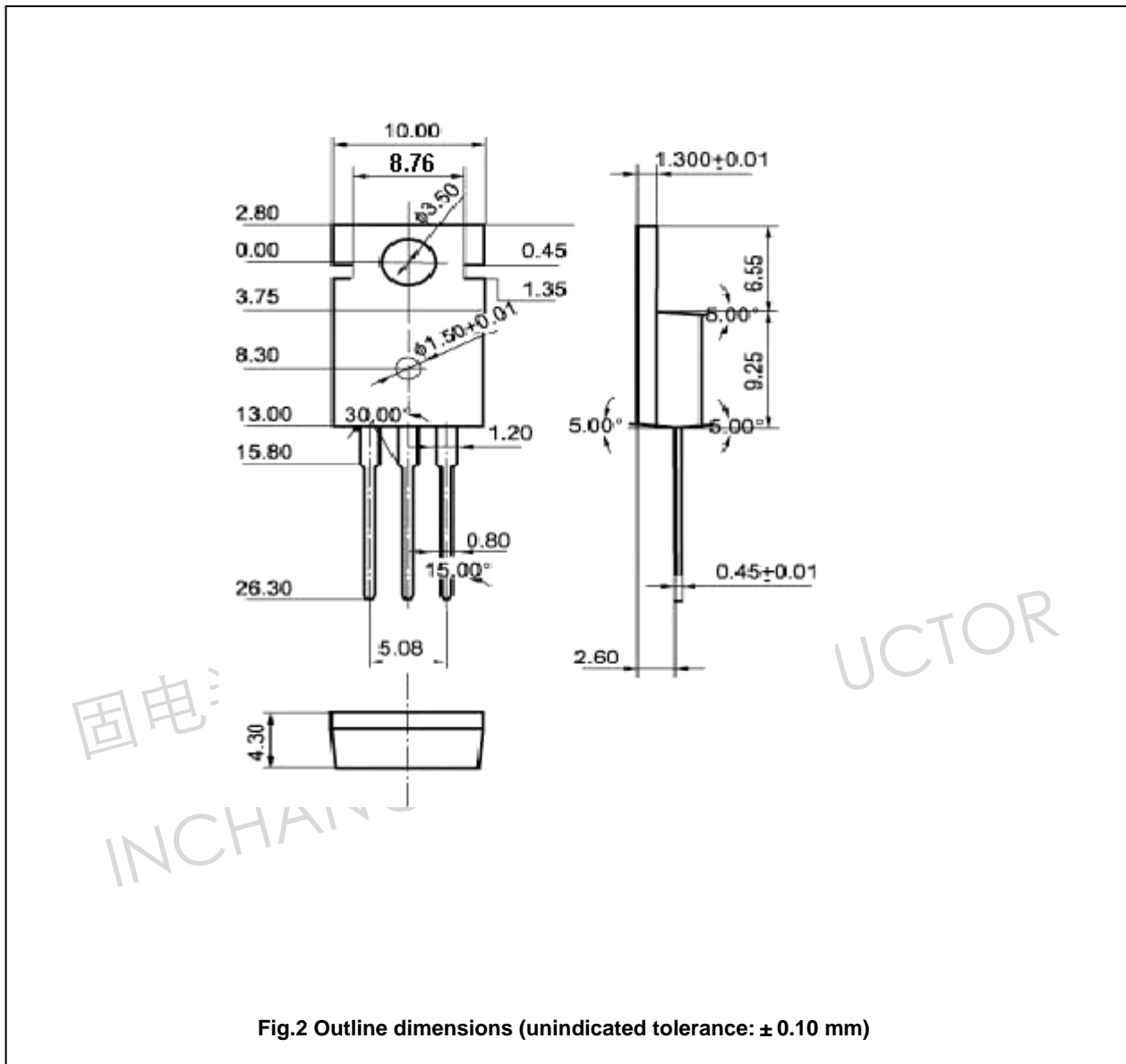

Silicon NPN Power Transistors

2SC3148

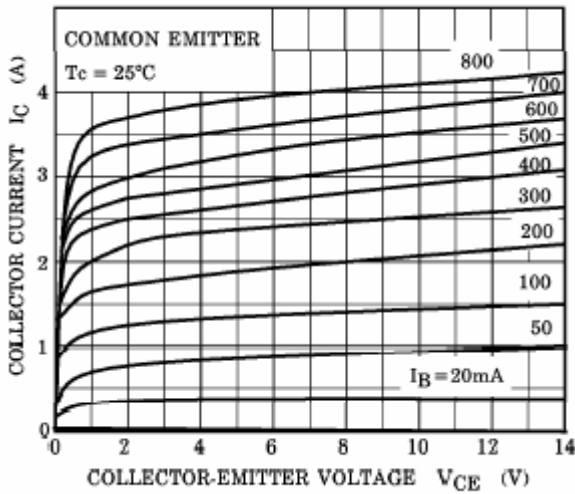

Fig.3 Static Characteristic

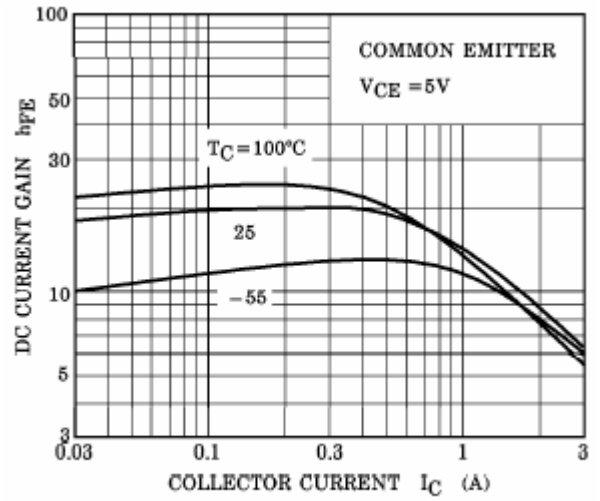

Fig.4 DC current Gain

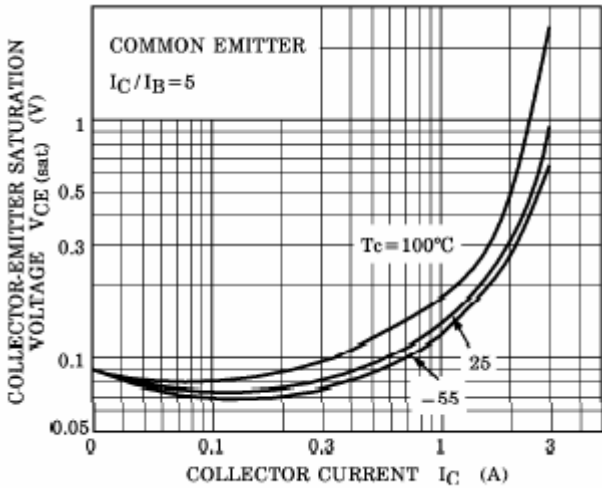

Fig.5 Collector-Emitter Saturation Voltage

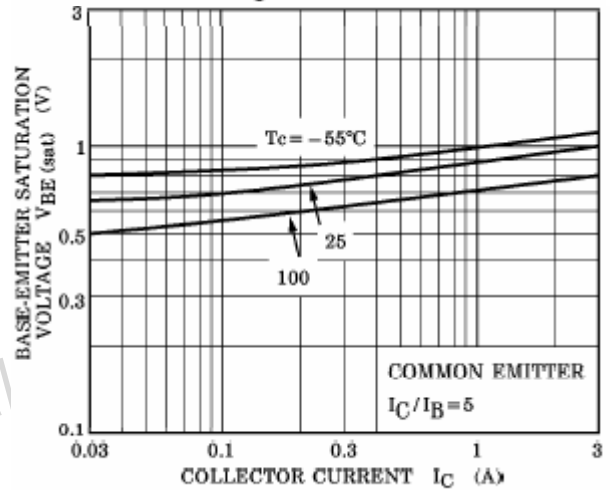

Fig.6 Base-Emitter Saturation Voltage

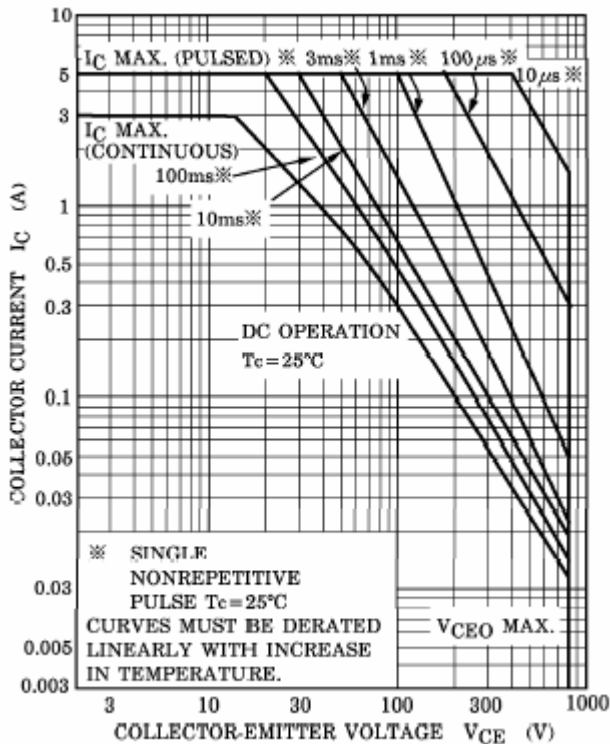

Fig.7 Safe Operating Area