

MINIATURE RELAY

1 POLE—1 to 2 A (FOR SIGNAL SWITCHING)

MZ SERIES

RoHS compliant



■ FEATURES

- Subminiature size
- Standard and high sensitivity types available
- UL, CSA recognized
- FCC rules and regulations part 68
—Dielectric strength 1,500 V between coil and contacts
- High reliability-bifurcated contacts available
- DIL pitch terminals
- Plastic sealed type
- RoHS compliant since date code: 0437L2
Please see page 6 for more information



■ ORDERING INFORMATION

[Example] $\frac{MZ}{(a)} \frac{F}{(b)} - \frac{12}{(c)} \frac{W}{(d)} \frac{HG}{(e)} - \frac{K}{(f)} - \frac{U}{(g)}$

(a)	Series Name	MZ : MZ Series
(b)	Dielectric Function	Nil : Standard type F : High dielectric strength type
(c)	Nominal Voltage	Refer to the COIL DATA CHART
(d)	Contact	Nil : 1 A single D : 2 A single (without MZF) W : 1 A bifurcated type
(e)	Coil Type	HG : Standard type (without MZ-D) (450-500mW) HS : High sensitivity type (without MZF/MZ-D) (190-270mW)
(f)	Enclosure	Nil : Flux free type K : Plastic sealed type
(g)	UL, CSA Standard	Nil : Non UL, • CSA approved type U : UL • CSA approved type

Note: For movable and stationary contact with gold overlay type, add suffix “-OH”.

MZ SERIES

■ COIL DATA CHART

	MODEL			Nominal voltage	Coil resistance ($\pm 10\%$)	Must operate voltage	Must release voltage	Nominal power
	Single		Bifurcated					
	2 A Type	1 A Type	1 A Type					
Standard Type	MZ-1.5D-(K)	MZ (F)-1.5HG-(K)	MZ-1.5WHG-(K)	1.5 VDC	5 Ω	1.05 VDC	0.08 VDC	450 mW
	MZ- 3 D-(K)	MZ (F)- 3 HG-(K)	MZ- 3 WHG-(K)	3 VDC	20 Ω	2.1 VDC	0.15 VDC	450 mW
	MZ-4.5D-(K)	MZ (F)-4.5HG-(K)	MZ-4.5WHG-(K)	4.5 VDC	45 Ω	3.15 VDC	0.23 VDC	450 mW
	MZ- 5 D-(K)	MZ (F)- 5 HG-(K)	MZ- 5 WHG-(K)	5 VDC	56 Ω	3.5 VDC	0.25 VDC	450 mW
	MZ- 6 D-(K)	MZ (F)- 6 HG-(K)	MZ- 6 WHG-(K)	6 VDC	80 Ω	4.2 VDC	0.3 VDC	450 mW
	MZ- 9 D-(K)	MZ (F)- 9 HG-(K)	MZ- 9 WHG-(K)	9 VDC	180 Ω	6.3 VDC	0.45 VDC	450 mW
	MZ-12 D-(K)	MZ (F)-12 HG-(K)	MZ-12 WHG-(K)	12 VDC	320 Ω	8.4 VDC	0.6 VDC	450 mW
	MZ-18 D-(K)	MZ (F)-18 HG-(K)	MZ-18 WHG-(K)	18 VDC	720 Ω	12.6 VDC	0.9 VDC	450 mW
	MZ-24 D-(K)	MZ (F)-24 HG-(K)	MZ-24 WHG-(K)	24 VDC	1,280 Ω	16.8 VDC	1.2 VDC	450 mW
	MZ-48 D-(K)	MZ (F)-48 HG-(K)	MZ-48 WHG-(K)	48 VDC	4,600 Ω	33.6 VDC	2.4 VDC	500 mW
High Sensitivity Type	MZ-1.5HS-(K)	MZ-1.5WHS-(K)		1.5 VDC	12 Ω	1.05 VDC	0.08 VDC	190 mW
	MZ- 3 HS-(K)	MZ- 3 WHS-(K)		3 VDC	45 Ω	2.1 VDC	0.15 VDC	200 mW
	MZ-4.5HS-(K)	MZ-4.5WHS-(K)		4.5 VDC	100 Ω	3.15 VDC	0.23 VDC	200 mW
	MZ- 5 HS-(K)	MZ- 5 WHS-(K)		5 VDC	120 Ω	3.5 VDC	0.25 VDC	200 mW
	MZ- 6 HS-(K)	MZ- 6 WHS-(K)		6 VDC	180 Ω	4.2 VDC	0.3 VDC	200 mW
	MZ- 9 HS-(K)	MZ- 9 WHS-(K)		9 VDC	400 Ω	6.3 VDC	0.45 VDC	200 mW
	MZ-12 HS-(K)	MZ-12 WHS-(K)		12 VDC	700 Ω	8.4 VDC	0.6 VDC	200 mW
	MZ-15 HS-(K)	MZ-15 WHS-(K)		15 VDC	1,100 Ω	10.5 VDC	0.75 VDC	200 mW
	MZ-18 HS-(K)	MZ-18 WHS-(K)		18 VDC	1,600 Ω	12.6 VDC	0.9 VDC	200 mW
	MZ-24 HS-(K)	MZ-24 WHS-(K)		24 VDC	2,800 Ω	16.8 VDC	1.2 VDC	200 mW
	MZ-48 HS-(K)	MZ-48 WHS-(K)		48 VDC	8,500 Ω	33.6 VDC	2.4 VDC	270 mW

Note: All values in the table are measured at 20°C.

■ SPECIFICATIONS

Item		Standard			High Sensitivity Type	
		Single		Bifurcated	Single	Bifurcated
		MZ-() D	MZ-() HG	MZ-() WHG	MZ-() HS	MZ-() WHS
Contact	Arrangement	1 form C (SPDT)				
	Material	Gold-overlay silver-nickel	Gold overlay silver-palladium			
	Resistance (initial)	Maximum 100 mΩ (at 1 A 6 VDC)				
	Rating (resistive)	2 A 24 VDC 1 A 120 VAC	1 A 24 VDC 0.5 A 120 VAC			
	Maximum Carrying Current	2 A				
	Maximum Switching Power	120 VA/48 W	60 AV/24 W			
	Maximum Switching Voltage	120 VAC, 60 VDC				
	Maximum Switching Current	2 A	1 A			
	Minimum Switching Load*	1 mA 1 VDC	0.1 mA 100 mVDC	1 mA 1 VDC	0.1 mA 100 mVDC	
	Capacitance (at 10 MHz)	Approximately 0.8 pF (between open contacts, adjacent contacts) Approximately 7.5 pF (between coil and contacts)				
Coil	Nominal Power (at 20°C)	450 to 500 mW			190 to 270 mW	
	Operate Power (at 20°C)	220 to 250 mW			100 to 130 mW	
	Operating Temperature	-30°C to +55°C (no frost)			-30°C to +75°C	
Time Value	Operate (at nominal voltage)	Maximum 6 ms				
	Release (at nominal voltage)	Maximum 3 ms				
Life	Mechanical	2 × 10 ⁷ operations minimum				
	Electrical (at rating)	1 A 120 VAC 1 × 10 ⁵ ops. min. 2 A 24 VDC 2 × 10 ⁵ ops. min.	0.5 A 120 VAC 2 × 10 ⁵ operations minimum 1 A 24 VAC 5 × 10 ⁵ operations minimum			
Other	Vibration Resistance	Misoperation	10 to 55 Hz (double amplitude of 3.28 mm)			
		Endurance	10 to 55 Hz (double amplitude of 3.28 mm)			
	Shock Resistance	Misoperation	100 m/s ² (11±1 ms)			
		Endurance	1,000 m/s ² (6±1 ms)			
	Weight	Approximately 3.5 g				

*1 Minimum switching loads mentioned above are reference values. Please perform the confirmation test with the actual load before production since reference values may vary according to switching frequencies, environmental conditions and expected reliability levels.

MZ SERIES

■ INSULATION

Item	Single	
Isolation (initial)	Minimum 100 MΩ (at 500VDC)	
Dielectric Strength	open contacts	Standard: 500VAC 1 min., High isolation: 1,000VAC 1 min.
	coil and contacts	Standard: 500VAC 1 min., High isolation: 1,500VAC 1 min.
Surge Voltage	1500V (coil-contact) (1/40 μs standard wave)	

■ SAFETY STANDARDS AND FILE NUMBERS

Type	Compliance	Contact rating
UL	UL 508 UL 60950-1 E 45026	Flammability: UL 94-V0 (plastics) [1A] 0.5A, 120VAC (resistive) 1A, 24VDC (resistive) [2A]
CSA	C22.2 No. 14 LR 35579	1A, 120VAC (resistive) 2A, 30VDC (resistive)

■ CHARACTERISTIC DATA

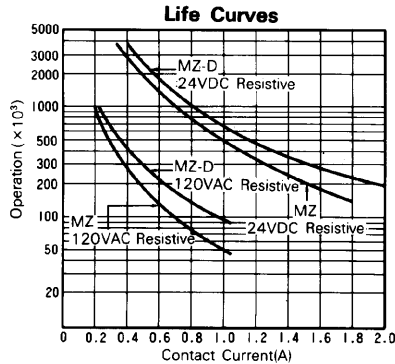
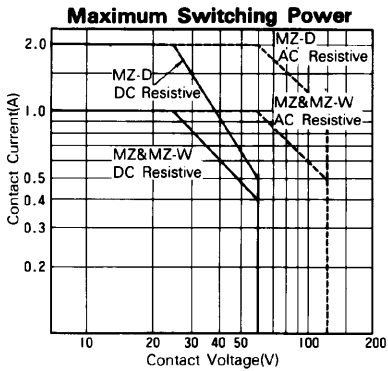
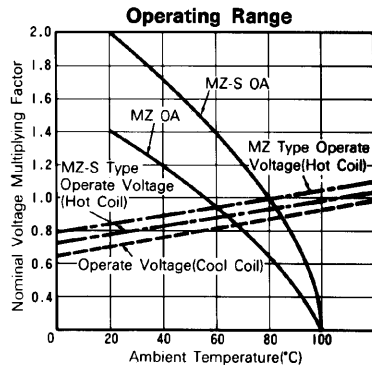
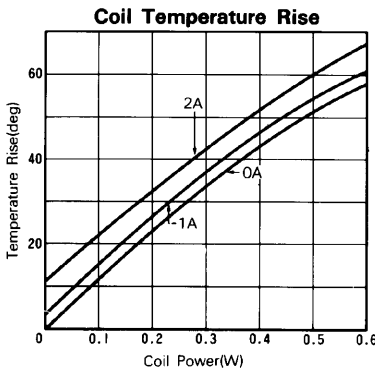
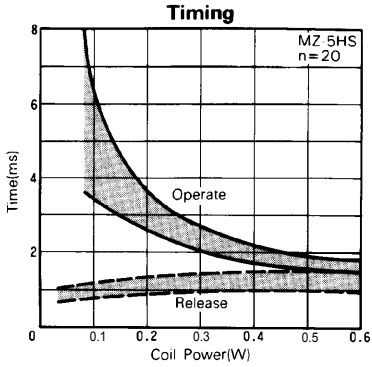

■ REFERENCE DATA

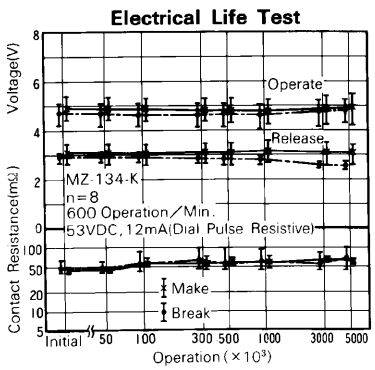
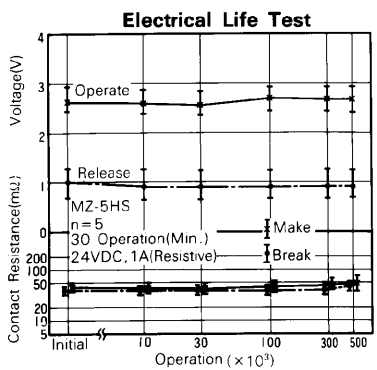
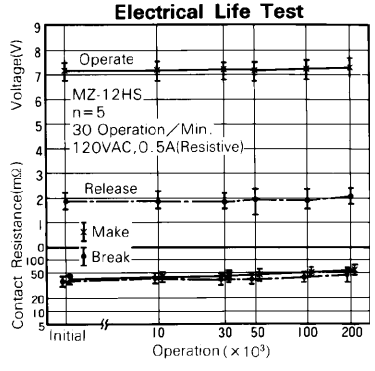
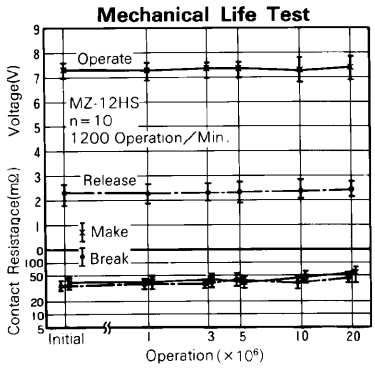
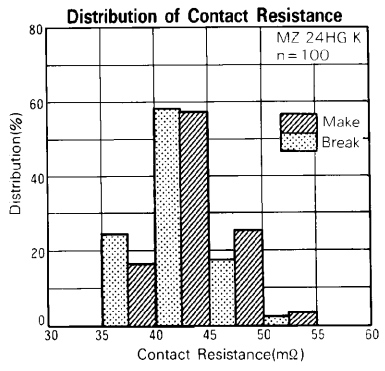
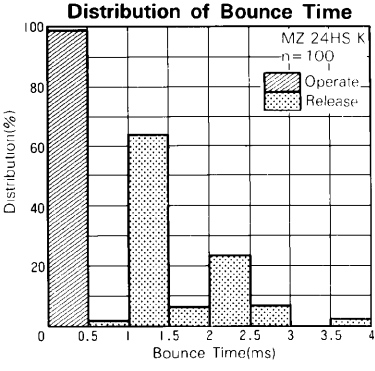
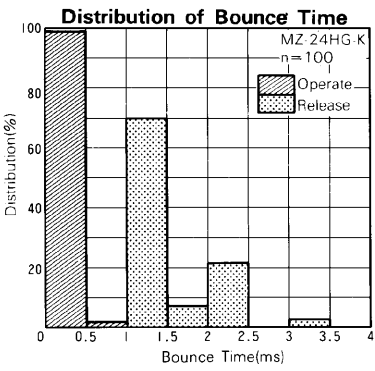
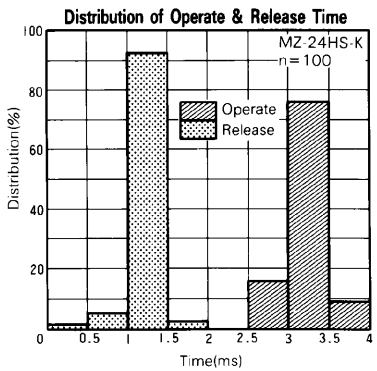
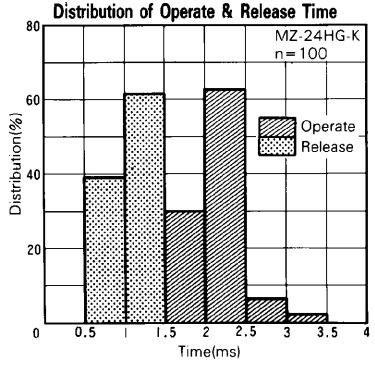
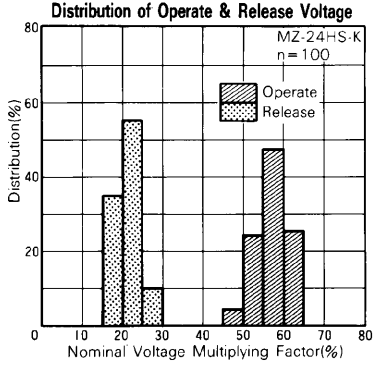
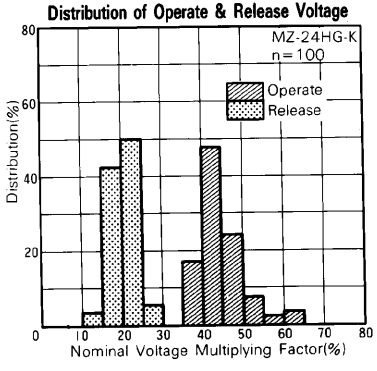

■ DIMENSIONS

● Dimensions

MZ (F) type (Flux free type)

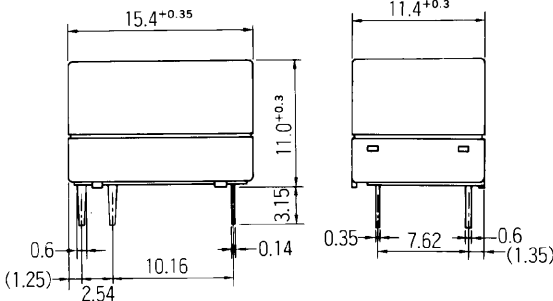

● Schematics (Bottom View)

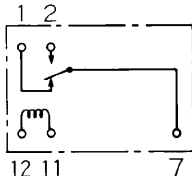

● PC board mounting hole layout (Bottom View)

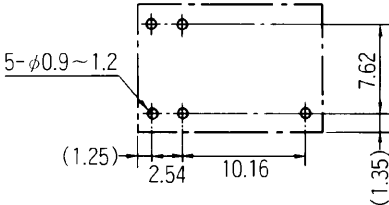

MZ (F)-K type (Plastic sealed type)

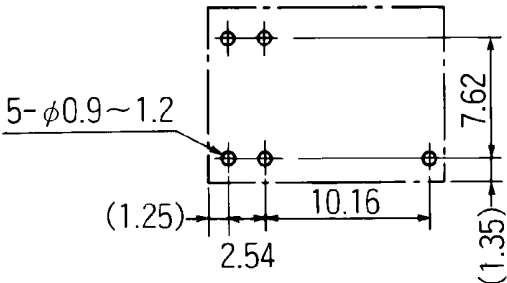
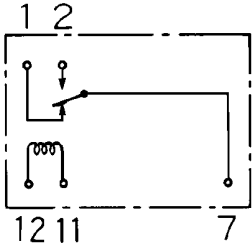

Unit: mm

RoHS Compliance and Lead Free Relay Information

1. General Information

- Relays produced after the specific date code that is indicated on each data sheet are lead-free now. Most of our signal and power relays are lead-free. Please refer to Lead-Free Status Info. (<http://www.fujitsu.com/us/downloads/MICRO/fcai/relays/lead-free-letter.pdf>)
- Lead free solder paste currently used in relays is Sn-3.0Ag-0.5Cu.
- All signal and most power relays also comply with RoHS. Please refer to individual data sheets. Relays that are RoHS compliant do not contain the 5 hazardous materials that are restricted by RoHS directive (lead, mercury, chromium IV, PBB, PBDE).
- It has been verified that using lead-free relays in leaded assembly process will not cause any problems (compatible).
- "LF" is marked on each outer and inner carton. (No marking on individual relays).
- To avoid leaded relays (for lead-free sample, etc.) please consult with area sales office.
- We will ship leaded relays as long as the leaded relay inventory exists.

Note: Cadmium was exempted from RoHS on October 21, 2005. (Amendment to Directive 2002/95/EC)

2. Recommended Lead Free Solder Profile

- Recommended solder paste Sn-3.0Ag-0.5Cu.

Reflow Solder condition

Flow Solder condition:

Pre-heating: maximum 120°C
Soldering: dip within 5 sec. at
260°C solder bath

Solder by Soldering Iron:

Soldering Iron
Temperature: maximum 360°C
Duration: maximum 3 sec.

We highly recommend that you confirm your actual solder conditions

3. Moisture Sensitivity

- Moisture Sensitivity Level standard is not applicable to electromechanical relays.

4. Tin Whisker

- Dipped SnAgCu solder is known as low risk tin whisker. No considerable length whisker was found by our in house test.

Fujitsu Components International Headquarter Offices

Japan

Fujitsu Component Limited
Gotanda-Chuo Building
3-5, Higashigotanda 2-chome, Shinagawa-ku
Tokyo 141, Japan
Tel: (81-3) 5449-7010
Fax: (81-3) 5449-2626
Email: promothq@ft.ed.fujitsu.com
Web: www.fcl.fujitsu.com

North and South America

Fujitsu Components America, Inc.
250 E. Caribbean Drive
Sunnyvale, CA 94089 U.S.A.
Tel: (1-408) 745-4900
Fax: (1-408) 745-4970
Email: components@us.fujitsu.com
Web: <http://www.fujitsu.com/us/services/edevices/components/>

Europe

Fujitsu Components Europe B.V.
Diamantlaan 25
2132 WV Hoofddorp
Netherlands
Tel: (31-23) 5560910
Fax: (31-23) 5560950
Email: info@fceu.fujitsu.com
Web: emea.fujitsu.com/components/

Asia Pacific

Fujitsu Components Asia Ltd.
102E Pasir Panjang Road
#01-01 Citilink Warehouse Complex
Singapore 118529
Tel: (65) 6375-8560
Fax: (65) 6273-3021
Email: fcal@fcal.fujitsu.com
Web: <http://www.fujitsu.com/sg/services/micro/components/>

©2008 Fujitsu Components America, Inc. All rights reserved. All trademarks or registered trademarks are the property of their respective owners.

Fujitsu Components America or its affiliates do not warrant that the content of datasheet is error free. In a continuing effort to improve our products Fujitsu Components America, Inc. or its affiliates reserve the right to change specifications/datasheets without prior notice.
Rev. January 9, 2008.